



# INSTALLATION AND OPERATION MANUAL



“BETTERPAN”

RECTANGULAR BRATT PANS, ELECTRIC TYPE  
MODD. UDBRE...\_V1 ; UDBRE...-C\_V1



Intertek



Intertek



**WARNING:**

Improper installation, operation, adjustment, alteration, service or maintenance can cause property damage, injury or death.

Read the installation, operating and maintenance instructions thoroughly before installing, operating or servicing this equipment.

IN CASE OF TECHNICAL ASSISTANCE, INDICATE:

MODEL : \_\_\_\_\_

NR. SERIAL : \_\_\_\_\_



The model and serial number are indicated on the rating plate

**firex**<sup>®</sup>

Firex srl, Z.I.Gresal, 28  
32036 Sedico  
BELLUNO ITALIA  
TELEPHONE: (0039) 852700 ; FAX: (0039) 852858



The manual is available upon request to:

[service@firex.it](mailto:service@firex.it)

specifying model and serial number

(The model and serial number data are indicated on the rating plate).

**TABLE OF CONTENTS**

<b>1</b>	<b>INTRODUCTION.....</b>	<b>6</b>
1.1	SYMBOLS AND PICTORIALS .....	6
1.2	GENERAL REMINDERS .....	6
1.3	IMPORTANT NOTES FOR INSTALLATION .....	7
<b>2</b>	<b>SAFETY.....</b>	<b>8</b>
2.1	OVERVIEW .....	8
2.2	WARNINGS.....	9
2.3	TABLE OF PAN PRODUCT LEVELS.....	11
<b>3</b>	<b>DESCRIPTION OF THE MACHINE.....</b>	<b>12</b>
3.1	DESCRIPTION .....	12
3.2	MATERIALS .....	12
3.3	OPTIONAL .....	12
3.3.1	CORE PROBE.....	12
3.3.2	SHOWER FOR WASHING.....	12
3.3.3	CASTERS.....	12
3.4	OPERATING PARTS.....	13
<b>4</b>	<b>TECHNICAL DATA .....</b>	<b>14</b>
4.1	TECHNICAL DATA UDBRE.._V1 ; UDBRE..-C_V1 .....	14
4.2	PLANT CONNECTION UDBRE029_V1 ; UDBRE029-C_V1.....	15
4.3	PLANT CONNECTION UDBRE038_V1 ; UDBRE038-C_V1.....	16
4.4	PLANT CONNECTION UDBRE048_V1 ; UDBRE048-C_V1.....	17
4.5	PLANT CONNECTION UDBRE058_V1 ; UDBRE058-C_V1.....	18
4.6	ELECTRICAL SPECIFICATIONS.....	19
<b>5</b>	<b>TRANSPORT, STORAGE, UNPACKING.....</b>	<b>20</b>
5.1	TRANSPORT .....	20
5.2	STORAGE .....	21
5.3	RECEIPT AND UNPACKING .....	21
<b>6</b>	<b>INSTALLATION.....</b>	<b>22</b>
6.1	INSTALLATION CODES AND STANDARDS.....	22
6.2	REQUIREMENTS FOR THE INSTALLATION SITE.....	22
6.3	POSITIONING .....	23
<b>7</b>	<b>CONNECTIONS.....</b>	<b>24</b>
7.1	ELECTRICAL CONNECTION .....	24
7.2	WATER CONNECTION.....	25
<b>8</b>	<b>COMMISSIONING AND TESTING.....</b>	<b>26</b>
<b>9</b>	<b>USING THE MACHINE.....</b>	<b>27</b>

<b>10 TOUCH SCREEN .....</b>	<b>27</b>
<b>11 MAIN MENU .....</b>	<b>28</b>
<b>12 SETTINGS MENU.....</b>	<b>29</b>
<b>13 PROGRAMS MENU .....</b>	<b>30</b>
<b>14 COOKING LAYOUT .....</b>	<b>31</b>
14.1 STATUS BAR .....	32
14.2 COOKING AREA.....	33
14.2.1 COOKING ICONS (MEANING) .....	34
14.3 MESSAGE COLUMN (L).....	35
14.4 FUNCTION BAR.....	36
14.4.1 START-STOP KEY FOR RUNNING PROGRAMS.....	36
14.4.2 EXTRA KEY.....	38
14.4.3 COOKING WITH DELAY TIMER KEY .....	38
<b>15 COOKING METHODS IN DETAIL.....</b>	<b>39</b>
15.1 COOKING.....	39
<b>16 SETTING SETPOINT PARAMETERS.....</b>	<b>40</b>
16.1 SETTING SETPOINT VALUES WITH THE KEYPAD .....	40
<b>17 COOKING PARAMETERS SETTING .....</b>	<b>42</b>
17.1 SETTING COOKING METHOD AND TEMPERATURE .....	42
17.2 SETTING COOKING TIME.....	43
<b>18 CREATING PROGRAMS (MULTI-PHASE).....</b>	<b>45</b>
18.1 CREATING/DELETING PHASES.....	45
18.2 MESSAGE SETTINGS.....	47
18.3 SAVING A PROGRAM .....	51
18.4 EDIT/ COPY/ RENAME PROGRAM .....	52
18.5 DELETING A PROGRAM.....	53
<b>19 RUNNING A PROGRAM/MANUAL COOKING.....</b>	<b>53</b>
19.1 RUNNING A PROGRAM/MANUAL COOKING .....	53
19.2 END OF COOKING.....	54
<b>20 RUNNING PROGRAMS (MULTI-PHASE).....</b>	<b>55</b>
20.1 RUNNING PROGRAMS (MULTI-PHASE).....	55
20.2 END OF PROGRAM.....	57
<b>21 COOKING WITH DELAY TIMER.....</b>	<b>58</b>
<b>22 FILLING PAN WITH H2O .....</b>	<b>59</b>
22.1 FILLING THE PAN WITH H2O USING A LITRE-COUNTER DEVICE .....	59
22.2 MANUALLY FILLING THE PAN WITH H2O.....	61
<b>23 COOKING WITH BASKETS (MOD.DBR ..-C).....</b>	<b>62</b>
23.1 SELECTING THE COOKING METHOD.....	62
23.2 SELECTING COOKING TIME.....	62

23.3	FITTING BARS AND BASKETS.....	62
23.4	STARTING HEATING.....	63
23.5	IMMERSING THE BASKETS .....	64
23.6	COOKING TIME (BASKET IMMERSION).....	65
23.7	END OF COOKING/HEATING .....	65
<b>24</b>	<b>MOVING THE PAN.....</b>	<b>66</b>
<b>25</b>	<b>CLEANING AND CARE .....</b>	<b>68</b>
25.1	GENERAL INFORMATION .....	68
25.2	DAILY CLEANING .....	68
25.3	PRECAUTIONS IN CASE OF PROLONGED INACTIVITY .....	69
25.4	PRECAUTIONS IN CASE OF MALFUNCTION.....	69
<b>26</b>	<b>MAINTENANCE.....</b>	<b>70</b>
26.1	MAINTENANCE OF THE APPLIANCE .....	70
26.2	PERIODIC MAINTENANCE .....	70
<b>27</b>	<b>DISPLAY MESSAGES .....</b>	<b>72</b>

# 1 INTRODUCTION

## 1.1 SYMBOLS AND PICTORIALS



### ATTENTION!

This indicates a dangerous operation or situation.



### ATTENTION!

This indicates a regulation or an obligation.



### ATTENTION!

This indicates the prohibition to carry out an operation.



### NOTE!

This indicates a recommendation or information deemed to be particularly important.

## 1.2 GENERAL REMINDERS



**The business units manager, where the unit will be installed, have an obligation, in accordance with the regulations, read carefully the contents of this manual and teach the operators and maintainers involved for parts that they compete.**



This manual contains all the necessary information for correct and safe use of our appliances. **Ensure this manual is conserved correctly so that it is always available to all users of the machine!**



**All installation work must only be carried out by a company belonging to the relevant industry register.**



**The manufacturer does not assume any responsibility or warranty commitment for accidents and damage due to non-compliance with the requirements or installation or maintenance not in accordance with safety standards.**

Also applies in case of improper use of the appliance by the operator.



**Any damage caused by water/steam infiltration or insects, due to the machine panels not being closed (after installation or maintenance) shall void any warranty claims.**

**Do not attempt to operate this unit in the event of a power failure.**

**Intended for commercial use only. Not for household use**

---

### 1.3 IMPORTANT NOTES FOR INSTALLATION

---

The following points are to insure the safe installation and operation of this equipment:



**Before connecting any parts of the appliance to supplies, make sure that the latter is equivalent the requirements stated in the rating plate, if the appliance has been designed for these supplies.**



**Observe all clearance requirements.**



**Disconnect the electrical power supply to the appliance before cleaning or servicing unit.**



**All service must be performed by a qualified Technician.**



**Keep the appliance area free and clear of combustible materials.**



**Always wear the personal protective equipment required by the regulations.**



**Follow the fire prevention regulations very carefully.**



**In the water supply systems the absence of "water hammer" must be guaranteed.  
Damage to the operation of the machine.**













## 2 SAFETY















### 2.1 OVERVIEW

- Read the warnings contained in this manual carefully as they provide important information regarding safe installation, maintenance and use.
- These appliances should only be used by personnel trained to use them.
- The appliance must be operated under close supervision.
- The appliance must only be used for the purpose for which it was explicitly designed, any other use is improper and as a result considered dangerous.
- This appliance is intended for professional use and therefore must be used by appropriately trained personnel
- Take particular care during operation as the outside of the appliance can also become very hot!
- It is essential to contact a specialist support centre for any repairs or maintenance.
- All the important information about the appliance for technical support can be found on the rating plate .
- When requesting technical support, you should describe the problem in detail in order to allow the technician to immediately understand the cause and type of fault.
- Certain operational faults may be due to operator error, therefore it is important for staff to receive comprehensive training.



## 2.2 WARNINGS

	<b>All installation and maintenance work must only be carried out by a company belonging to the relevant industry register.</b>
	<b>Fire protection regulations must be strictly adhered to.</b>
	<b>The machine should be serviced at least once a year to ensure it is in prime condition.</b> Therefore, it is recommended to sign a maintenance contract with a reliable technical support centre.
	The appliance can only be used for cooking food in industrial kitchens. <b>Any other use is considered improper use and, therefore, dangerous.</b> <b>Intended for commercial use only. Not for household use.</b>
	The appliances should only be used by personnel trained to use them. The appliance must be operated under close supervision.
	<b>Keep the appliance area free and clear of combustible materials.</b>
	<b>Do not attempt to operate this unit in the event of a power failure.</b>
	<b>Any damage caused by water/steam infiltration or insects, due to the machine panels not being closed (after installation or maintenance) shall void any warranty claims.</b>
	<b>The manufacturer assumes no responsibility for injuries or damage due to non-compliance with safety regulations or improper use of the appliance by the operator.</b>
	<b>The appliance is not intended to be used by persons (including children) with reduced physical, sensory or mental abilities, or lack of experience or knowledge, unless they are supervised, by someone responsible for their safety, or given instructions regarding the use of the appliance.</b> <b>Children should be supervised at all times so that they do not play with the appliance.</b>
	<b>Wear rubber gloves, goggles or a face shield and protective clothing when using the appliance.</b> <b>Risk of scalding!</b>
	The machine controls can only be hand operated. Damage caused by the use of pointed, sharp and similar objects shall void any warranty claims.
	<b>It is essential to wash the inside of the cooking pan thoroughly before setting up the appliance for first use.</b>

	The cooking pan must be filled respecting the minimum and maximum values (including the food to be cooked) indicated in the table depending on the cooking method.
	When emptying the pan, the operator must position him/herself on the right-hand side of the machine (control side) being careful of any hot content spilling from the pan and avoiding any splashes. The operator must also ensure that any persons present in the room maintain a safe distance of at least 2 metres from the perimeter of the machine, both while emptying and replacing the pan.
	Take particular care during operation as the surfaces become hot.
	When filling the pan with water, using a tap or shower (optional), make sure that there is no hot oil in the pan.
	The appliance must be disconnected from the power supply during cleaning, maintenance and replacement of the internal parts.
	When cleaning the appliance, never use jets of water or a steam cleaner to avoid infiltration and damage to components.
	Most cleaning products are harmful to the skin, eyes, mucous membranes, and clothes. Precautions must be taken. Wear rubber gloves, safety glasses/goggles or a face shield, and protective clothing. Read the warnings carefully and follow the directions on the label of the detergent.
	The floor may be slippery in the area around the appliance.
	If the power cord is damaged, it must be replaced by the manufacturer or by a servicing company or a similarly qualified person in order to avoid hazards.
	When an appliance is supplied on casters (optional), there is a restraint on the appliance and, if disconnected of the restraint is necessary, to reconnect this restraint after the appliance has been returned to its original position.
	Switch off the appliance in case of breakdown, malfunction or water leakage. Disconnect all water, electricity and gas supplies and contact a support centre.
	In the event of a fire, cover the cooking pan by closing the lid and disconnect all water, electricity and gas supplies.
	<b>NEVER USE WATER</b> to extinguish a fire.
	Do not store or use flammable gases or liquids near the machine.

## 2.3 TABLE OF PAN PRODUCT LEVELS



**ATTENTION:**

The cooking pan must be filled respecting the minimum and maximum values (including the food to be cooked) indicated in the table depending on the cooking method.



**ATTENTION:**

Failure to comply with this requirement may cause serious injury to persons and compromise the operation of the appliance

Cooking method	PAN LEVELS TO BE RESPECTED

### 3 DESCRIPTION OF THE MACHINE

#### 3.1 DESCRIPTION

Electronically controlled rectangular multipurpose bratt pans.  
Designed to perform the main types of cooking: braising, boiling, pressure cooking and frying.  
UDBR..-C versions with automatic basket lifting system.



The appliance can only be used for cooking food in industrial kitchens. **Any other use is considered improper use and, therefore, dangerous**

#### 3.2 MATERIALS

Cooking pan in AISI 304 grade stainless steel  
Double-walled lid in AISI 304 grade stainless steel  
Outer cover in fine satin AISI 304 grade stainless steel.  
Self-supporting frame in AISI 304 grade stainless steel.  
Adjustable feet for levelling in AISI 304 grade stainless steel, equipped with removable cover for cleaning operations.

#### 3.3 OPTIONAL

##### 3.3.1 Core probe

For precise temperature measurements, insert the probe in the centre of the product to be processed, ensuring that it is as far in as possible.



When not used, always place the probe in the appropriate housing on the lid to avoid any damage.

##### 3.3.2 Shower for washing

The shower has a twist-out type system. Pull out gently until the desired or maximum length is reached. To return, it is necessary to tug gently outwards and then twist it back into position.

Press the black lever to operate the water jet. The flow of water immediately stops when released. If you want to have a continuous jet of water, turn the black lever as far as you can.



Handle this accessory with care and store it in its housing at the end of each use to avoid damaging it.  
**Make sure there is no hot oil in the pan before using the jet.**

##### 3.3.3 Casters

The appliances can be installed on casters. The front two have brakes: to engage them, press gently on the lever above the castor, to release them, press more firmly.



**Always engage the castor brakes if you do not have to move the appliance.**

## 3.4 OPERATING PARTS

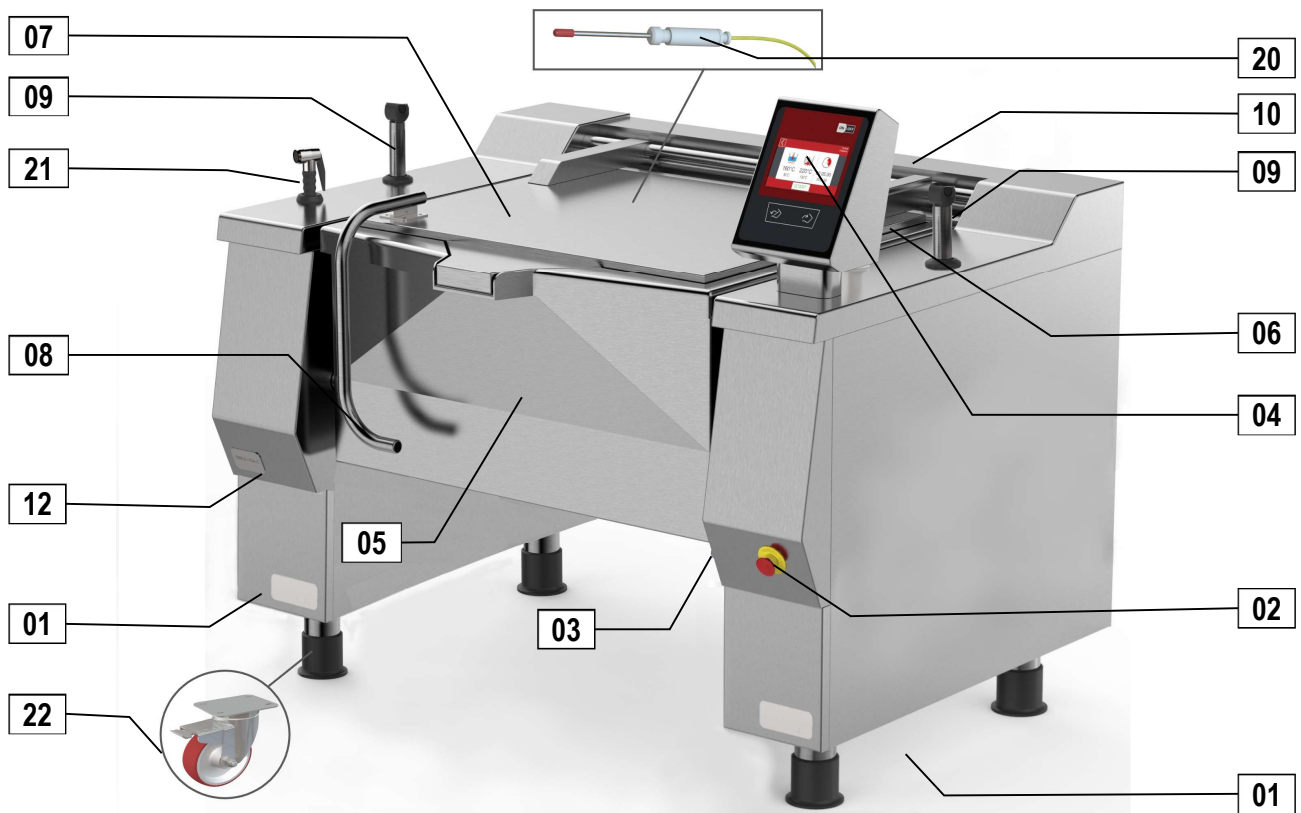

- 01** Technical Data Plate
- 02** Emergency button
- 03** USB slot
- 04** Touch Screen
- 05** Cooking pan
- 06** Fill tap
- 07** Lid
- 08** Lid handle

- 09** Basket lifter (mod.-C)
- 10** Steam vent (gas)

**OPTIONAL**

- 20** Core probe
- 21** Shower
- 22** Castors

## 4 TECHNICAL DATA

### 4.1 TECHNICAL DATA UDBRE..\_V1 ; UDBRE..-C\_V1

	UDBRE.._V1	029	038	048	058
TECHNICAL DATA (DIMENSIONS)					
Equipment dim.A	Inches	57.87	67.91	78.74	88.78
Equipment dim.B	Inches	44.29			
Equipment dim.H1	Inches	50.51			
Equipment dim.H	Inches	37.40			
Equipment dim.H2	Inches	75.98			
Tank drain height H3	Inches	19.09			
TECHNICAL DATA (FUNCTIONALITY)					
Pan dimension A	Inches	31.69	41.73	52.56	62.60
Pan dimension B	Inches	25.59			
Pan dimension H	Inches	16.54			
Pan area	Inches <sup>2</sup>	806	1069	1348	1596
Overvall volume	Gallons	34	45	57	68
Useful volume	Gallons	29	38	48	58
Basket lifting (mod.-C)	no. (GN)	2 (1/1)	3 (1/1)	4 (1/1)	4 (1/1)
Temperature	°F (°C)	68÷482 (20÷250)			
TECHNICAL DATA (INSTALLATION)					
Electric power **	kW	See tab.ELECTRICAL SPEFICATIONS			
(E) Voltage/Input **	V (A)	3 PHASE 208V ; 3 PHASE 220-240 V			
IPX	IPX	5			
Water pressure	PSI (kPa)	25-50 (170-345)			
(A) Hot water inlet	Ø"	3/4 "			
(B) Cold water inlet	Ø"	3/4 "			
Sound level	dbA	< 70			
TECHNICAL DATA (STORAGE/MOVEMENT)					
Packaging dim.A	Inches	63	72	84	94
Packaging dim.B	Inches	48	48	48	48
Packaging dim.H	Inches	58	58	58	58
Volume	ft <sup>3</sup>	101	116	136	151
Net weight	lbs	1014	1146	1268	1322
Gross weight	lbs	1202	1367	1500	1565

\*\*Verify on rating plate .

4.2 PLANT CONNECTION UDBRE029\_V1 ; UDBRE029-C\_V1

LEGEND:			
<b>E</b>	Electrical connection (Conduit 1-1/4")	<b>A</b>	Hot water connection
<b>BACK</b>	See "CLEARANCE REQUIREMENTS"	<b>B</b>	Cold water connection

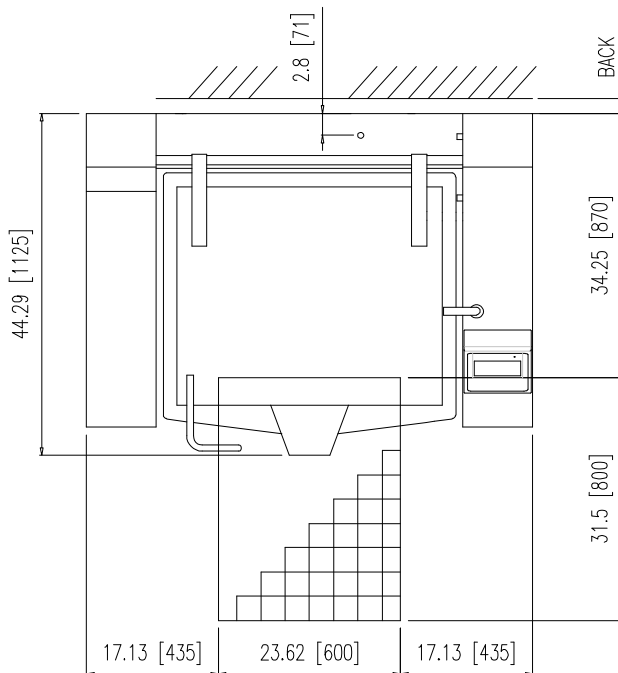
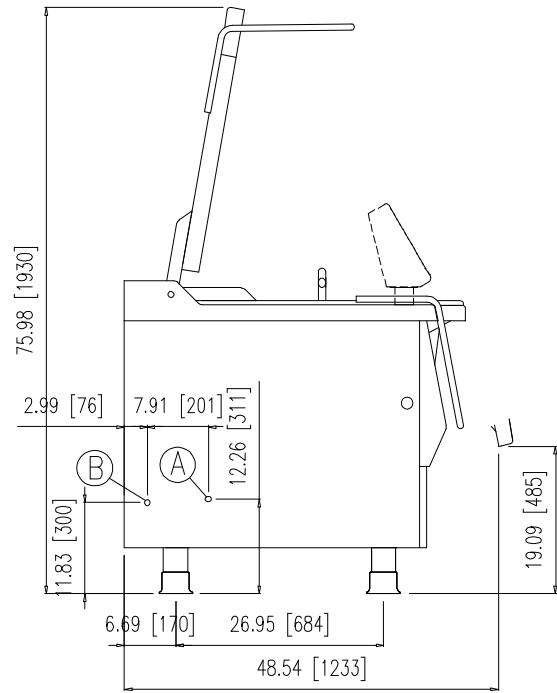
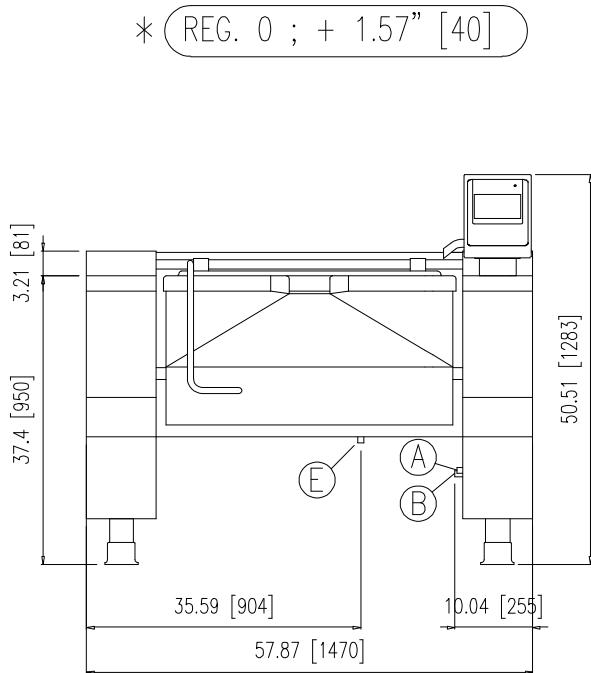

**4.3 PLANT CONNECTION UDBRE038\_V1 ; UDBRE038-C\_V1**

LEGEND:			
<b>E</b>	Electrical connection (Conduit 1-1/4")	<b>A</b>	Hot water connection
<b>BACK</b>	See "CLEARANCE REQUIREMENTS"	<b>B</b>	Cold water connection

\* REG. 0 ; + 1.57" [40]

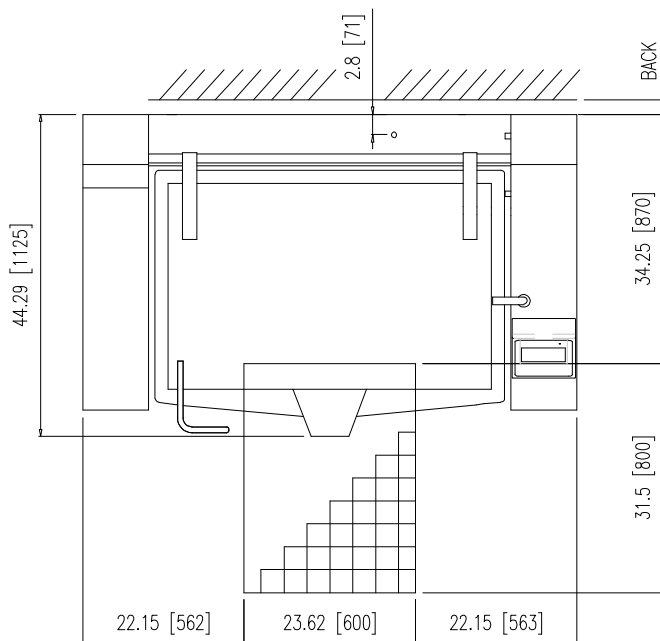
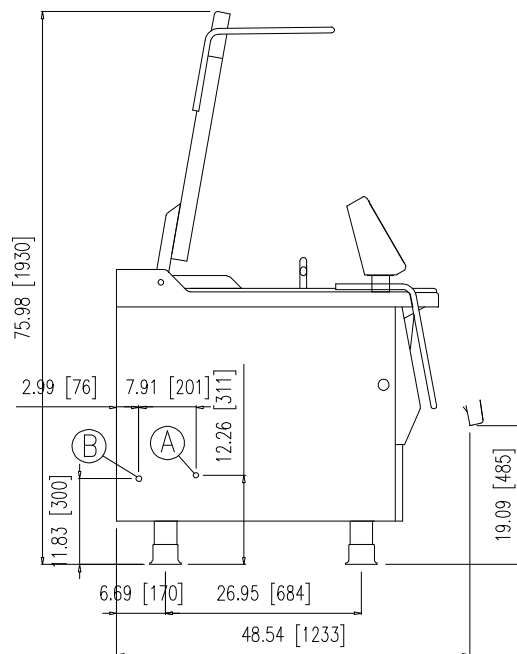
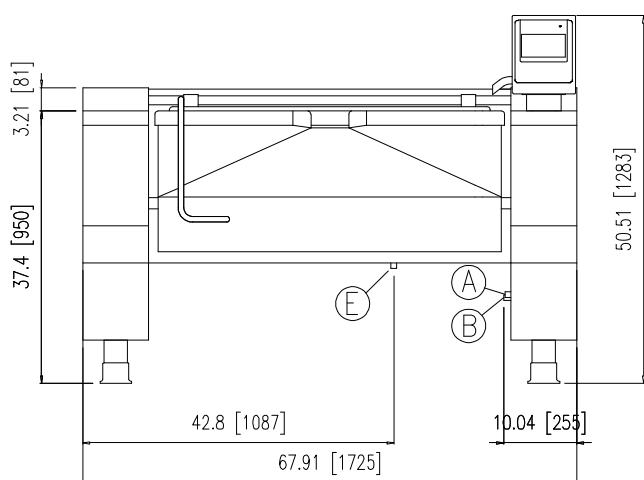



4.4 PLANT CONNECTION UDBRE048\_V1 ; UDBRE048-C\_V1

LEGEND:			
<b>E</b>	Electrical connection (Conduit 1-1/4")	<b>A</b>	Hot water connection
<b>BACK</b>	See "CLEARANCE REQUIREMENTS"	<b>B</b>	Cold water connection

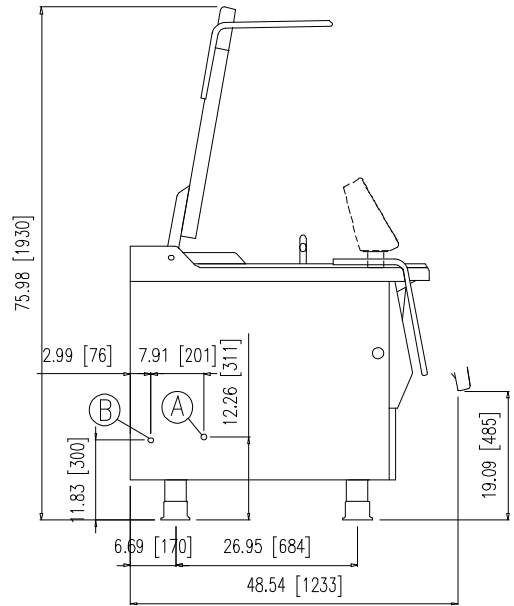
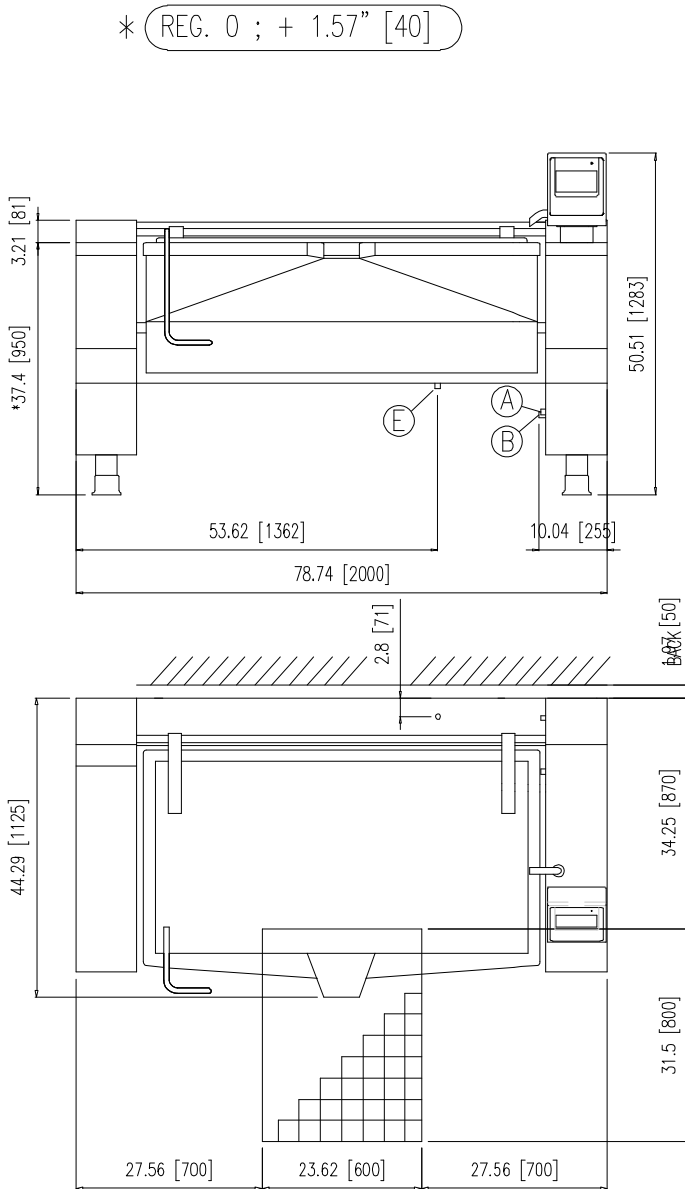

**4.5 PLANT CONNECTION UDBRE058\_V1 ; UDBRE058-C\_V1**

LEGEND:			
<b>E</b>	Electrical connection (Conduit 1-1/4")	<b>A</b>	Hot water connection
<b>BACK</b>	See "CLEARANCE REQUIREMENTS"	<b>B</b>	Cold water connection

\* REG. 0 ; + 1.57" [40]

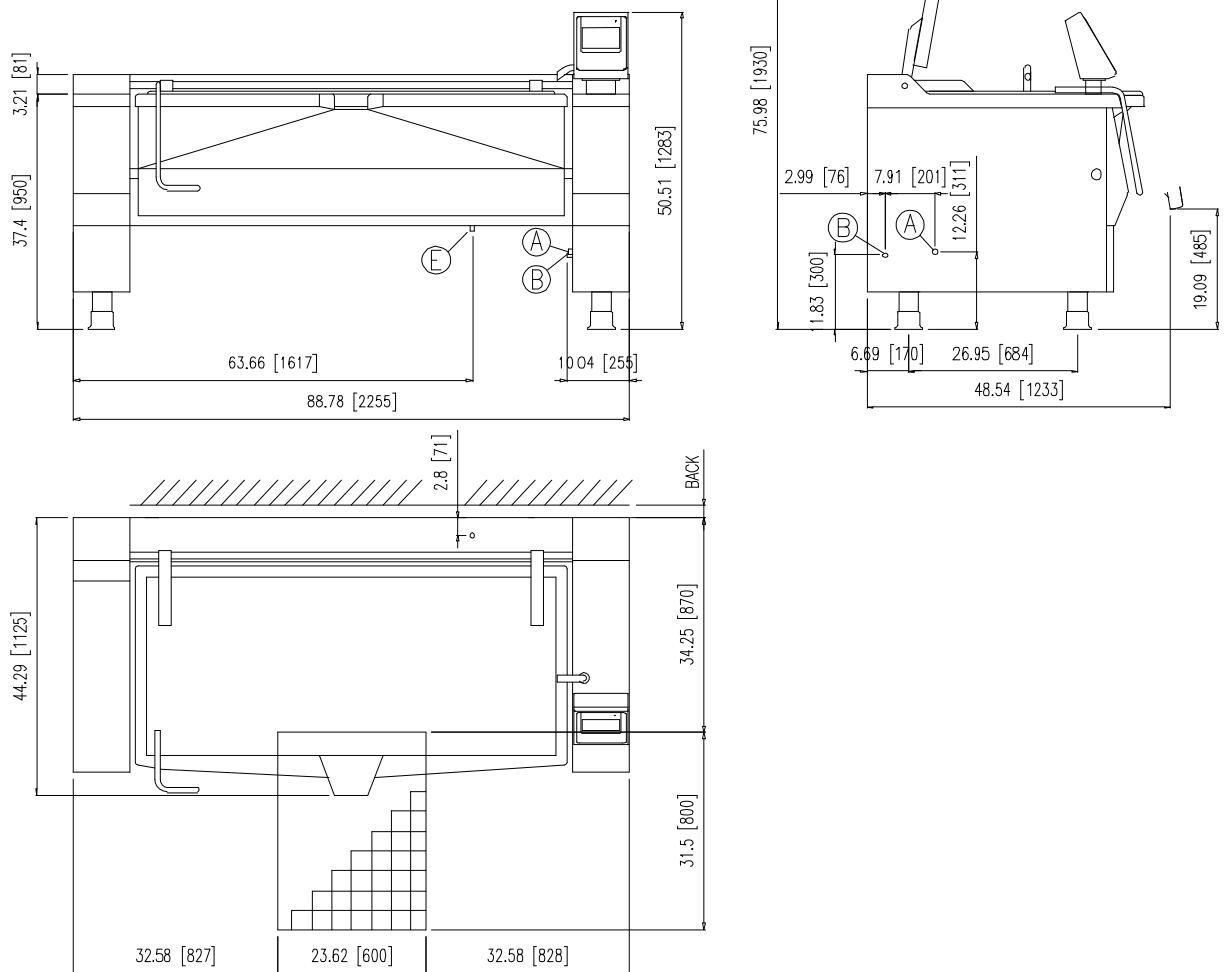

**4.6 ELECTRICAL SPECIFICATIONS**

MODEL	208 V			220-240 V		
	Phase	kW	Amps	Phase	kW	Amps
UDBRE029_V1	3	16.5	55.0 *	3	16.5	47.7 *
UDBRE029-C_V1						
UDBRE038_V1	3	19.8	55.0	3	19.8	47.7
UDBRE038-C_V1						
UDBRE048_V1	3	26.4	82.5 *	3	26.4	71.5 *
UDBRE048-C_V1						
UDBRE058_V1	3	29.7	82.5	3	29.7	71.5
UDBRE058-C_V1						

\*LOAD NOT BALANCED.

\*AMPS VALUE EXPRESSED FOR THE MAXIMUM CURRENT

## 5 TRANSPORT, STORAGE, UNPACKING

### 5.1 TRANSPORT



The movement of the machine must be performed by a qualified operator for use of lifting and transport equipment in accordance with the laws of the country of the user of the machine.

The machine can be transported with a normal means (forklift or transpallet) capable of supporting its weight and size (see tab. "TECHNICAL DATA").



Always check the correct balance of the weight of the machine (B = center of gravity) to prevent unexpected movement or dropping to the floor of the car with damage to people or things around you.

For transport on pallets, Fig.1

For transport without pallets, Fig.2

Fig.1

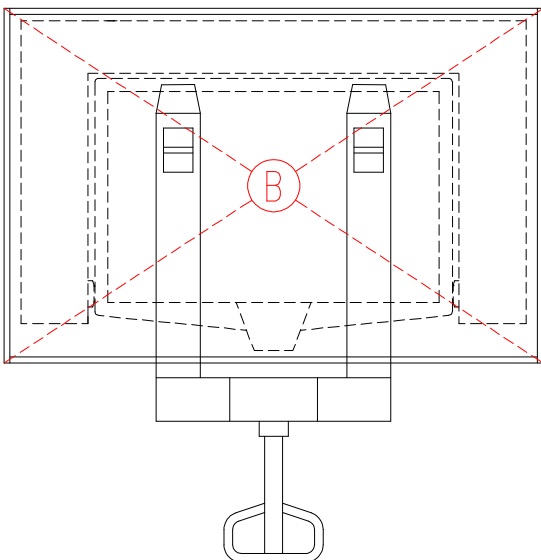
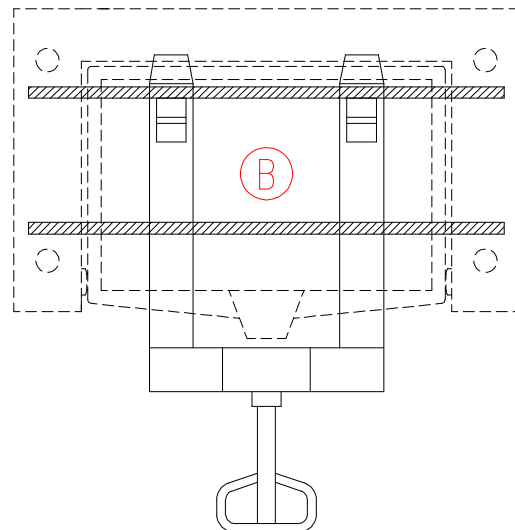

Fig.2



---

## 5.2 STORAGE

---



**Store the appliance in a closed environment protected against atmospheric agents. Keep the appliance away from humidity and temperature ranges**



**Protect the appliance from shocks and stresses**



**Ensure that the appliance is in contact with corrosive substances**

---

## 5.3 RECEIPT AND UNPACKING

---



Upon receipt of the machine check that the packaging is undamaged. If it does not withdraw the conditional commodity producing photographic evidence of any apparent damage.



**After removing the packaging, check that the appliance is undamaged. In case of visible damage, do not connect the appliance but contact the sales outlet immediately.**



Check for the presence of individual components with packing lists.



Remove from the panels of the machine the protective film PVC .



Before disposing of the packaging materials **make sure that they do not contain machine elements** (accessory; tools; documentation, etc)



**Dispose of the packaging components in accordance with the regulations in force on waste disposal.**

## 6 INSTALLATION

### 6.1 INSTALLATION CODES AND STANDARDS

Electrical grounding must be provided in accordance with local codes, or in the absence of local codes, with the National Electrical Code, ANSI/NFPA 70, or the Canadian Electrical Code, CSA C22.2, as applicable.

The electrical diagram is located on the inside of side panel of right hand console.

### 6.2 REQUIREMENTS FOR THE INSTALLATION SITE

The room in which the appliance is to operate must be well ventilated.

The appliance belongs to the installation class A1 (no direct connection of a chimney or flue exhaust system is required), so it is very important for the environment in which it is installed to be well-aired and provided with all the safety openings prescribed for its power.

#### VENTILATION

The appliance are only to be installed under a ventilation hood in a room which has provisions for adequate make up air.

Information on the construction and installation of ventilating hoods may be obtained from the standard for "Vapor Removal from Cooking Equipment", NFPA No. 96 (latest edition), available from the National Fire Protection Association, Batterymarch Park, Quincy, MA, USA, 02269.



**The electrical isolating switch and the water shutoff valves must both be located near to the appliance, within easy reach for the user.**

6.3 POSITIONING

**CLEARANCE REQUIREMENTS**

This unit must be installed in accordance with the clearances shown on the rating label which is adhered to the unit.

CLEARANCES		
	Combustible construction	Noncombustible construction
Back	0"	0"
Right Side	0"	0"
Left Side	0"	0"
<b>"Suitable for installation on combustible floors"</b>		

There are no particular prescriptions regarding side distances from other appliances or walls, however it is advisable to leave enough space (20/30 " : 50/70 cm) in case of maintenance and/or repairs.



**The appliance must stand level.** Small differences in level can be eliminated by screwing or unscrewing the adjustable feet. **A significantly uneven or sloping stance can affect the operation of the appliance adversely.**  
**Adjust the bottom foot on each leg to overcome an uneven floor.**



If the appliance is equipped with casters (optional), leveling must be ensured by the floor. If the floor is not level, it must be made such with thicknesses in correspondence of the wheels. The surface and the inclination of the shims must be such as not to affect the stability of the machine.



**After positioning remove the bars under the frame.**  
 It is advisable to keep the bars so that they are available for subsequent movements.

## 7 CONNECTIONS



**Attention:** When the appliance is equipped with casters (optional), the appliance shall be installed using a flexible conduit.

**Adequate means must be provided to limit the movement of the appliance without depending on or transmitting stress to the electrical conduit.**

**The location where the restraining means may be attached to the appliance are the two eyebolts positioned on the back of the appliance.**



**Utility connections must be made with flexible lines of sufficient length to allow the equipment to be moved for cleaning of the equipment and adjacent area.**

### 7.1 ELECTRICAL CONNECTION



**During installation, observe the regulations provided by the local electricity company.**



**The appliance is supplied to operate according to the power supply indicated on appliance's rating plate.**



A separate fused disconnect switch must be supplied and installed. The appliance must be electrically grounded by the installer.

The earthing system must be efficient.



The electric supply must match the power requirements specified on the appliance's rating plate.

The copper wiring must be adequate to carry the required current at the rated voltage.

The connection point is indicated in the "**PLANT CONNECTION**"



Ensure main power is turned off before connecting wires.

The terminal board can be reached by unloosing the screws (on the back-side of the appliance) on the bracket fastening the terminal board housing. The whole housing will come down and the terminal board will be easy to reach.

Insert the cable through the cable gland. Carefully connect the conductors to the corresponding terminals. The earth conductor must be longer than the other conductors, so as to disconnect last in the event of a strong pull of the cable or break of the cable gland. Tighten the cable gland.





Any damage caused by water/steam infiltration or insects, due to the machine panels not being closed (after installation or maintenance) shall void any warranty claims.

## 7.2 WATER CONNECTION



The equipment is to be installed with adequate backflow protection to comply with applicable federal, state, and local codes.



The water pressure in the supply network must be between the values indicated in the "INSTALLATION TECHNICAL DATA" table.  
If not, install a pressure reducer upstream of the appliance.



Before making the water connection, carefully clean the connection pipe. It is advisable to let the water flow to clean the whole piping. Any impurities could compromise the operation of the machine.

The diameter of the connections is indicated in "INSTALLATION TECHNICAL DATA"

The connection point is indicated in the "PLANT CONNECTION"

Install a shut-off valve upstream of the appliance, one for each water connection on the appliance, near the appliance and in a position easily accessible by the user.

## 8 COMMISSIONING AND TESTING

Once all the connections have been made, the appliance and the overall installation must be checked following the directions given in this manual.

### CHECK IN PARTICULAR:

- That the protective film has been removed from the external surfaces;
- That the panels of the machine are closed correctly;
- That connections have been made in accordance with the requirements and directions indicated in this manual;
- That all safety requirements in current standards, statutory regulations and directives have been met;
- That the power cable is not subjected to traction and is not in contact with hot surfaces;
- That the water, gas and steam connections are tight and not subjected to traction.

Now proceed to light the appliance as directed in the instructions for use.

While the appliance is in use, voltage should not differ from the nominal voltage more than +/- 10%.



**The test report must be completed in full and submitted to the customer who should then sign in acceptance. With effect from this moment, the appliance is covered by the manufacturer's warranty**

Attention if the display shows:

	<p>The safety thermostat of the equipment has intervened. The equipment is switched off.</p>	<p>The safety thermostat can be disarmed during transport without any anomalies, or with temperatures close to 0 ° C  <b>Disconnect the machine from the power supply.</b></p> <p>Remove the lower right control panel and reset the thermostat, pressing firmly on the red thermostat button.          In case of new thermostat intervention <b>contact the assistance service.</b></p>
---	--	---

## 9 USING THE MACHINE

## 10 TOUCH SCREEN

1-On-off switch

2- 7" TFT resistive display

3- Keypad for movements (mixer, pan)

2- 7" TFT resistive display

1-On-off switch

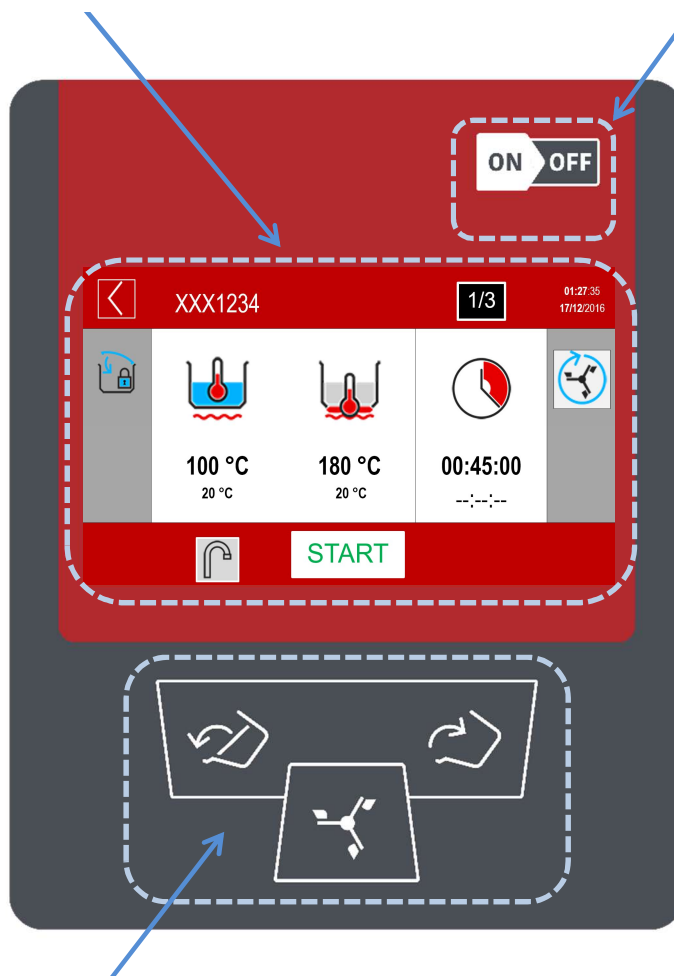

3- Keypad for movements (mixer, pan)

## 11 MAIN MENU

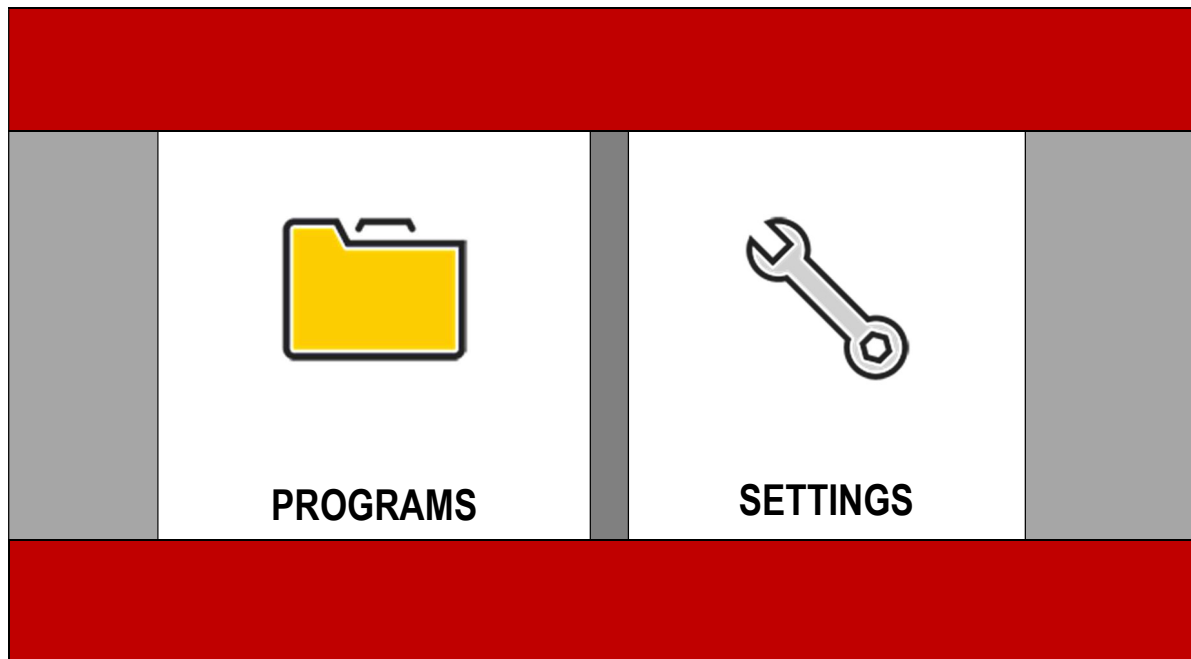

### PROGRAMS

- Setting manual cooking parameters
- Carrying out manual cooking
- Running cooking programs

### SETTINGS

Appliance setting-user;

- creating-editing cooking programs
- language
- date-time
- firmware update
- colors
- EXPORT (HACCP data)

Appliance setting - installer/technical assistant;

- TEST I/O
- Parameter setting (unit of measurement)
- Import database

## 12 SETTINGS MENU

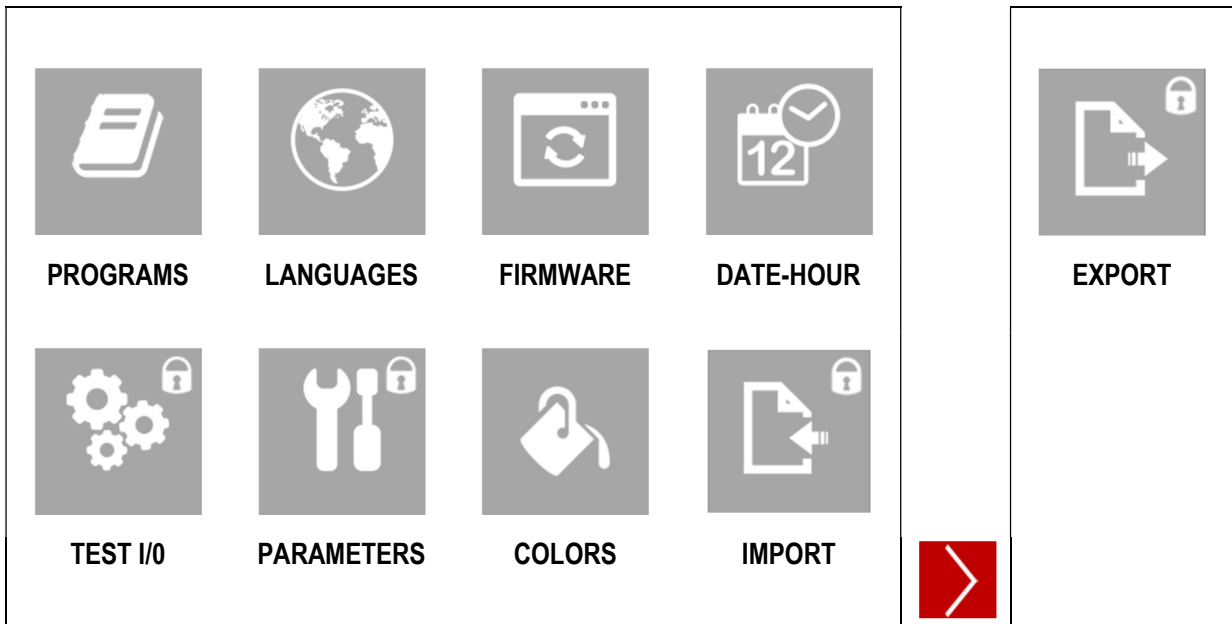





<b>PROGRAMS</b>	<ul style="list-style-type: none"> <li>• Creating-editing cooking programs</li> </ul>
<b>LANGUAGES</b>	<ul style="list-style-type: none"> <li>• Language setting</li> </ul>
<b>FIRMWARE</b>	<ul style="list-style-type: none"> <li>• Firmware update (from USB)</li> </ul>
<b>DATE-HOUR</b>	<ul style="list-style-type: none"> <li>• Current Date and Time setting</li> </ul>

<b>TEST I/O</b>	<ul style="list-style-type: none"> <li>• Test I/O board (only with password)</li> </ul>
<b>PARAMETERS</b>	<ul style="list-style-type: none"> <li>• Parameter setting (only with password)</li> </ul>
<b>COLORS</b>	<ul style="list-style-type: none"> <li>• Screen colour setting</li> </ul>
<b>IMPORT</b>	<ul style="list-style-type: none"> <li>• Import database (parameters, cooking, languages, programs) only with password.</li> </ul>

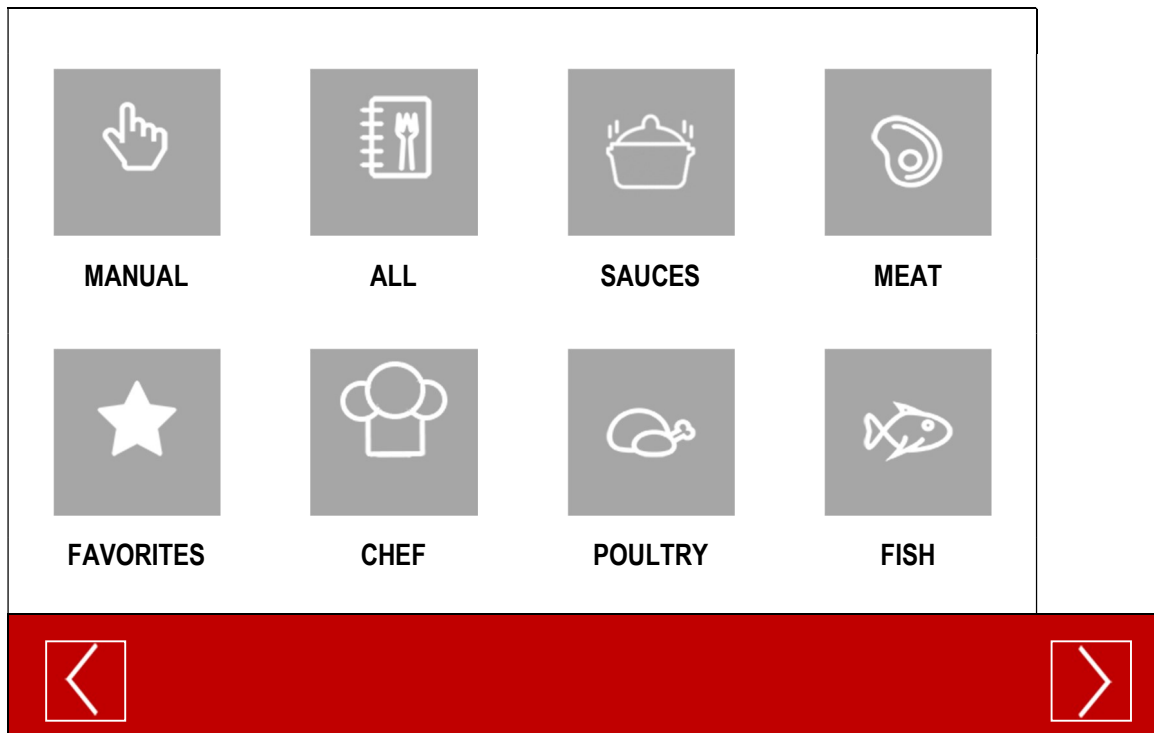
<b>EXPORT</b>	<ul style="list-style-type: none"> <li>• Export (HACCP data).Read the instruction manual dedicated to HACCP.</li> </ul>
---------------	---

## 13 PROGRAMS MENU



 <p><b>MANUAL</b></p>	<ul style="list-style-type: none"> <li>• Setting manual cooking parameters</li> <li>• Carrying out manual cooking</li> </ul>
 <p><b>ALL</b></p>  <p><b>FAVORITES</b></p>  <p><b>MEAT ETC</b></p>	<ul style="list-style-type: none"> <li>• Running cooking programs</li> </ul>

14 COOKING LAYOUT

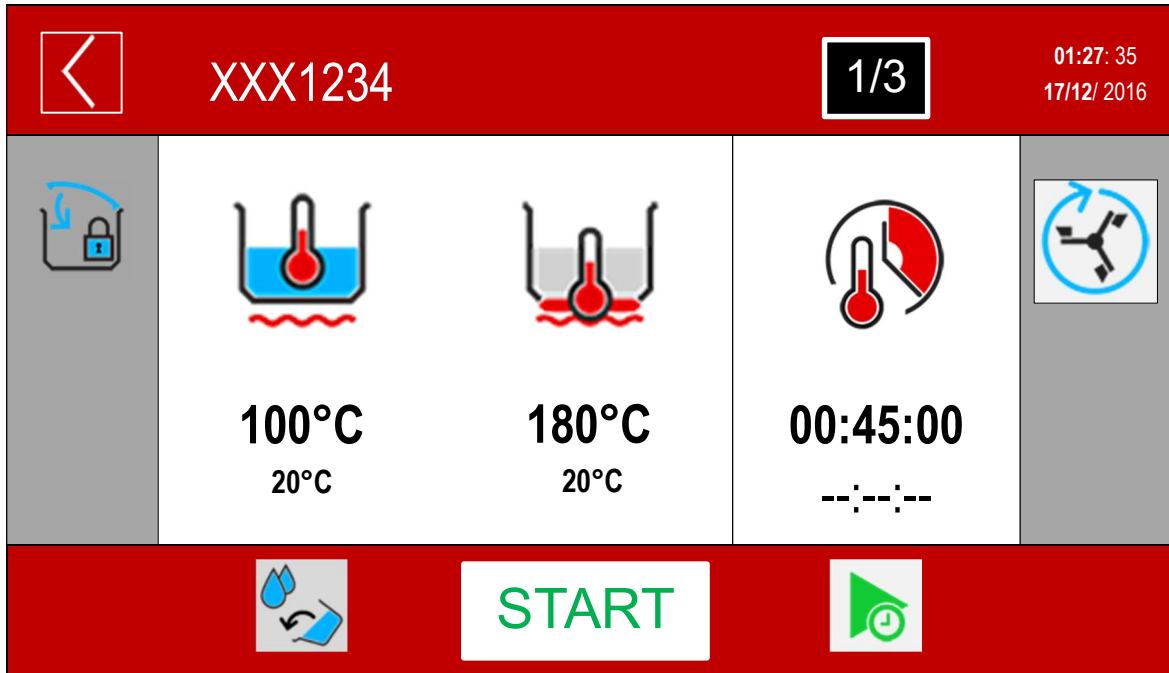

STATUS BAR



↓ COOKING AREA

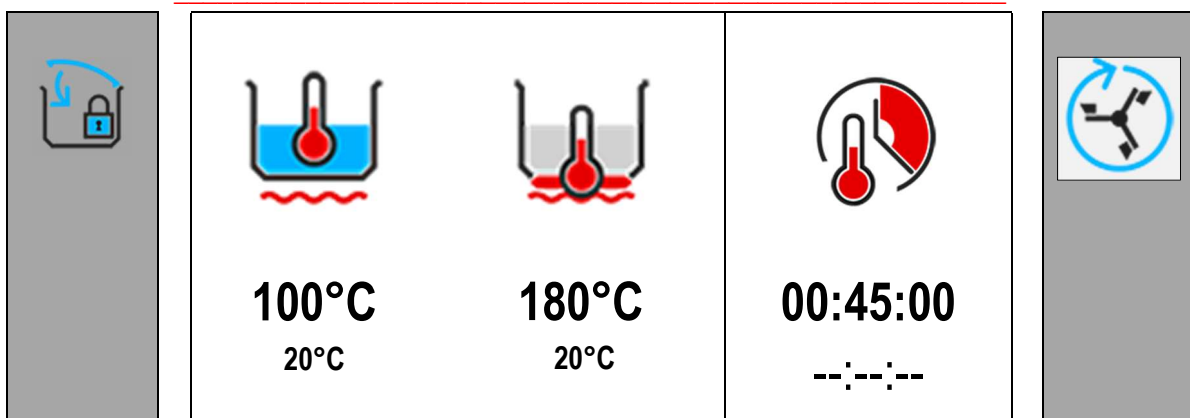

↑ MESSAGE COLUMN

FUNCTION COLUMN ↑

FUNCTION BAR



## 14.1 STATUS BAR



1

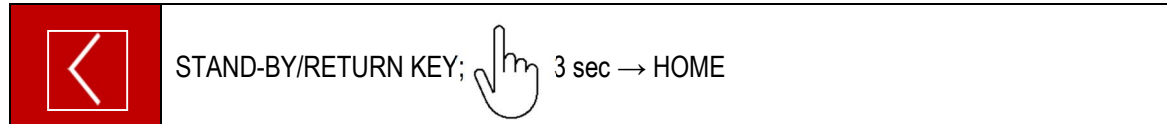

↓

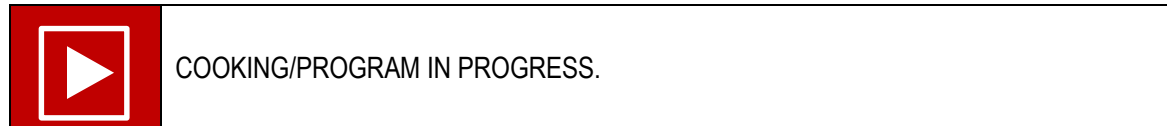

↓

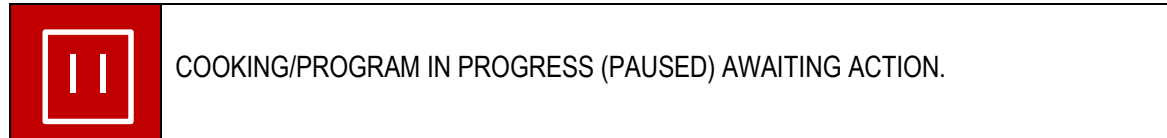

2

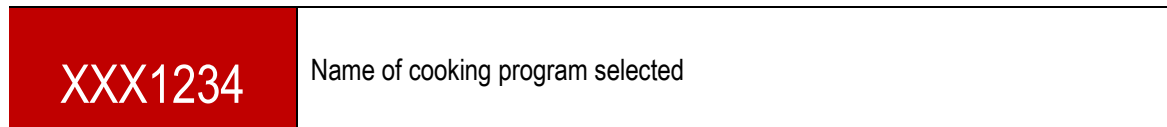

3

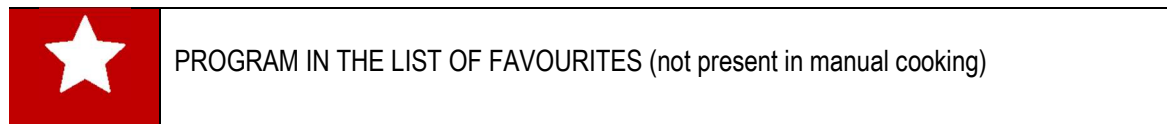

4

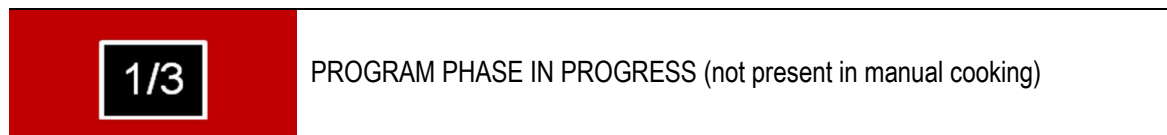







5





14.2 COOKING AREA

COOKING METHOD>				< TIME TYPE
SETPOINT >	<b>100°C</b>	<b>180°C</b>	<b>00:45:00</b>	< SETPOINT
VALUE MEASURED>	<b>20°C</b> 	<b>20°C</b>	--:--:--	< COUNTDOWN

	<ul style="list-style-type: none"> <li>• HEATING IN OPERATION</li> </ul>
	<ul style="list-style-type: none"> <li>• MINIMUM HEATING</li> </ul>
	<ul style="list-style-type: none"> <li>• HEATING OFF AS SETPOINT REACHED OR FOR WAITING (L COLUMN ICONS)</li> </ul>

### 14.2.1 COOKING ICONS (MEANING)

Left or central icon: main control (when the SETPOINT is reached, heating stops and **the countdown of the cooking time starts**)

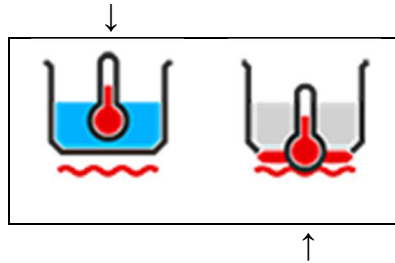













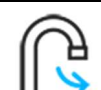

Right icon: secondary control (when the SETPOINT is reached, the heating stops)

Name	Icon	Description
		Temperature at bottom
		Temperature in the pan
		$\Delta$ Temperature between bottom and main temperature
		H2O temperature in the pan
		Core probe temperature

## 14.3 MESSAGE COLUMN (L)

## INFORMATION AND REQUESTS INDICATOR L COLUMN

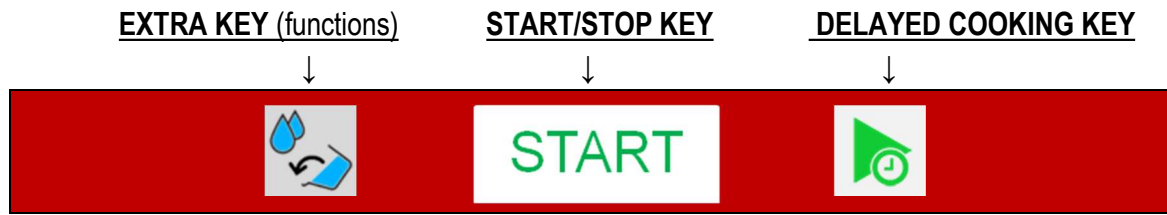

buzzer	Light Indicator	Icon	Description	Behaviour
no	no		Pan out of position (for cooking)	Icon present when pan out of position
no	no		Pan movement not allowed	Icon present only when you want to perform a pan movement in an unauthorised phase.
B			<u>Request</u> to completely open the lid (for pan movement)	Icon present only when you want to move the pan and the lid is not completely open.
B			<u>Request</u> to turn the tap (for pan movement) <i>Attn. alternate icon</i>	Icon present only when you want to move the pan and the tap is not completely turned (towards the outside of the pan).
B			<u>Request</u> to turn the tap (to fill pan with H2O) <i>Attn. alternate icon</i>	Icon present only when you want to fill pan with H2O and the tap is not completely turned (towards the pan).
no	no		Not allowed to fill pan with H2O	Icon present only when you want to fill pan with H2O during an unauthorised phase.
A			Safety thermostat has been triggered	Icon present when the safety thermostat has been triggered. To reset the alarm, restore the safety thermostat.
A			Insufficient gas pressure	Icon present when gas pressure switch has been triggered.
A			Gas central unit reset	Icon present due to interruption in the gas central unit

## 14.4 FUNCTION BAR







### 14.4.1 START-STOP KEY FOR RUNNING PROGRAMS

**Attention:** the START/STOP key indicates the action that will be performed by pressing the key!  
The machine status is indicated by the icon on the top left

With key presence	Machine status	icon on the top left
	Machine in stand-by.	

Pressing the START key starts the program and the START key becomes the STOP.

With key presence	Machine status	icon on the top left
	Program running.  or 	 

To avoid accidentally stopping the cooking program in progress, press the STOP key and the following screen appears:



If the STOP key has been pressed incorrectly, wait approximately 5 seconds and you return to the program in progress.

If instead you want to stop the program, slide the coloured square from the triangle to the square and release the key.

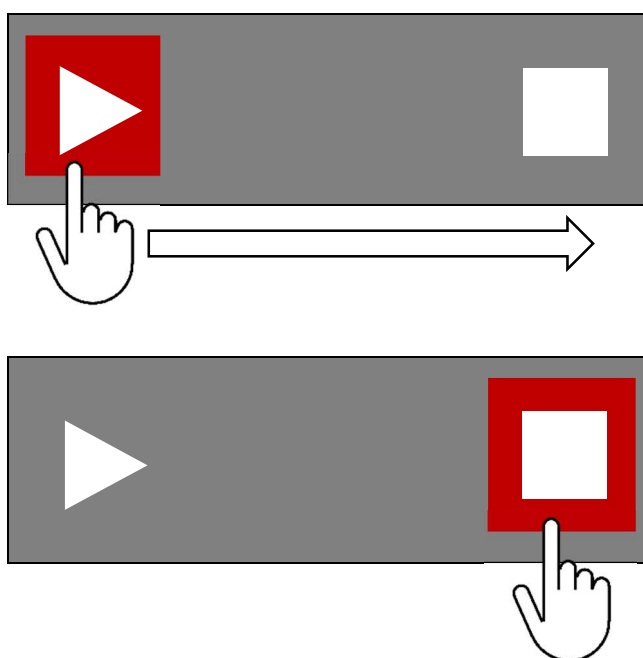

The STOP key becomes START.

---

**14.4.2 EXTRA KEY**

---

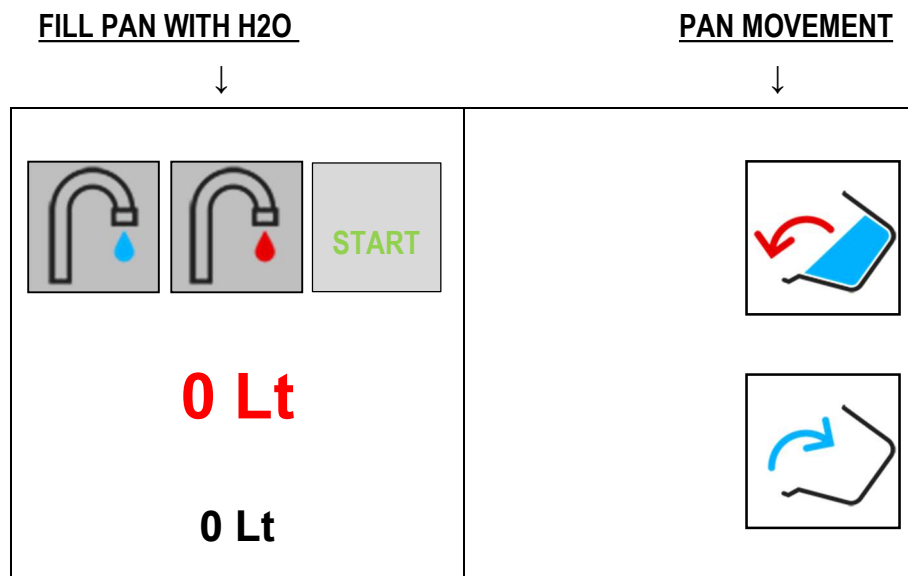

Pressing the key  it is possible to access the following functions: H2O loading into the vessel, vessel tilting and motorized vessel discharge (optional)

**FILLING PAN WITH H2O**

- LITRE-COUNTER DEVICE ACCURACY +/- 2% AND MAX H2O TEMPERATURE 140°F (60°C)
- MAX LITRES = PAN CAPACITY

---

**14.4.3 COOKING WITH DELAY TIMER KEY**





---



Press the key  to access the settings for cooking with delay timer.

## 15 COOKING METHODS IN DETAIL

### 15.1 COOKING

Icon	Description
	<p>For braising that requires a temperature up to 250°C; the temperature regulation is controlled by the sensor (PT1000) located on the bottom of the pan</p>
	<p>For all cooking in water that requires a maximum temperature of 100°C; the temperature regulation is controlled by the sensor (PT1000) located inside the pan, in contact with the product, and by the sensor placed on the bottom of the pan</p>
	<p>For cooking that requires accurate regulation and monitoring of the temperature at the core of the product; the temperature regulation is controlled by the probe (PT1000) placed inside the product.</p>
	<p>For gentle and slow cooking that require accurate regulation and monitoring of the temperature at the core of the product, the temperature regulation is controlled by the probe placed inside the product and the difference set between the bottom and the inside of the product.</p>

## 16 SETTING SETPOINT PARAMETERS

### 16.1 SETTING SETPOINT VALUES WITH THE KEYPAD

The following screen appears when setting any setpoint value:

left column: parameter of which you are changing the setpoint value.

right column: keypad + cursor for changing the setpoint.

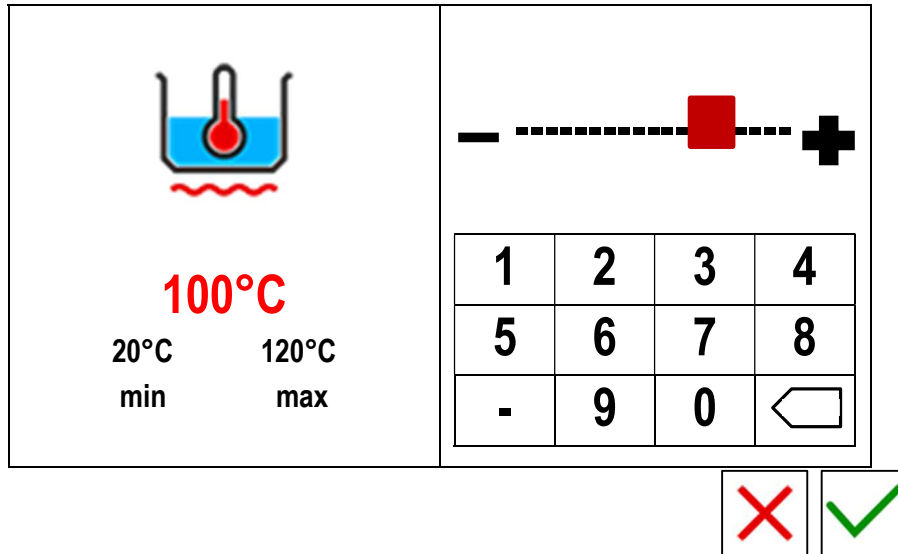

Fields in the left column have the following meanings:

<b>100°C</b>	RED VALUE: VALUE OF WHICH YOUR ARE CHANGING THE SET
<b>20°C min</b>	MINIMUM VALUE SETTABLE
<b>120°C max</b>	MAXIMUM VALUE SETTABLE



The values in the right column will be changed as follows:

### SETTING WITH KEYPAD

TYPE THE DESIRED VALUE.

**ATTENTION** : THE VALUE MUST BE BETWEEN **min** AND **max**!

### SETTING WITH CURSOR

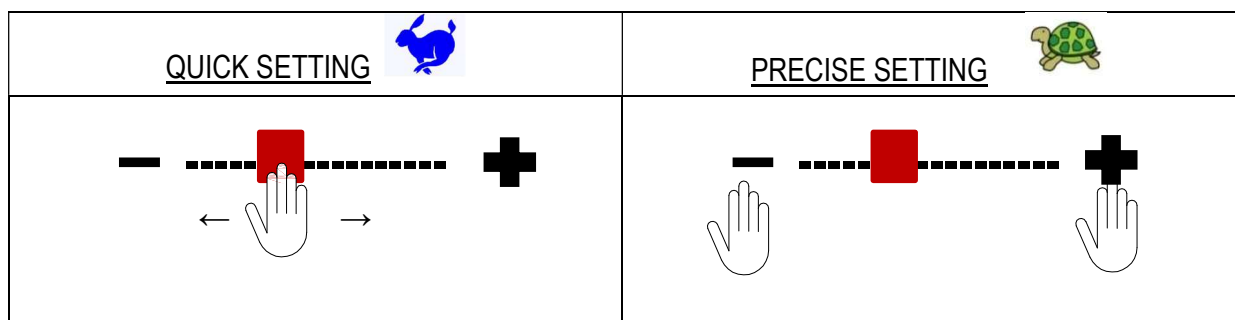

### EXIT FROM SETTINGS



Exit without confirming settings key



Exit confirming settings key

## 17 COOKING PARAMETERS SETTING

The setting of the following parameters can only be made from the menu:

1. PROGRAMS + MANUAL
2. SETTINGS + PROGRAMS

### 17.1 SETTING COOKING METHOD AND TEMPERATURE

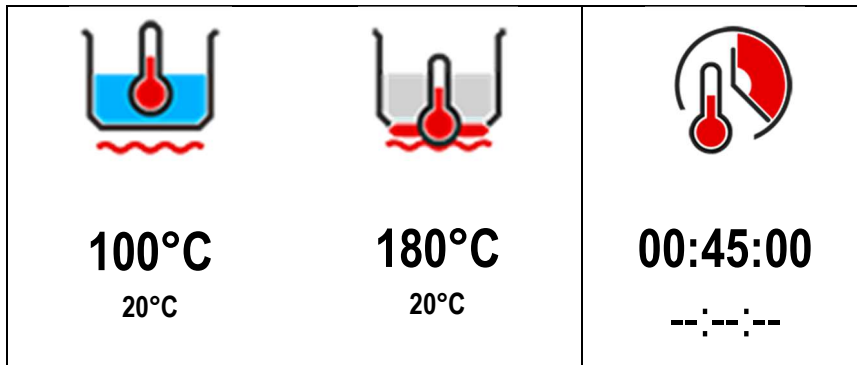

AREA HIGHLIGHTED = SELECTION/SETTINGS



#### SETTING COOKING METHOD

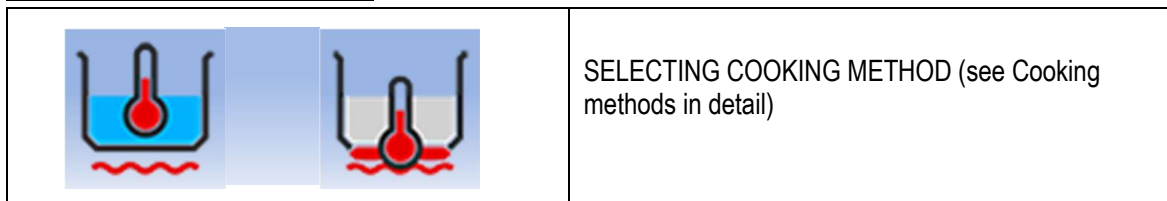

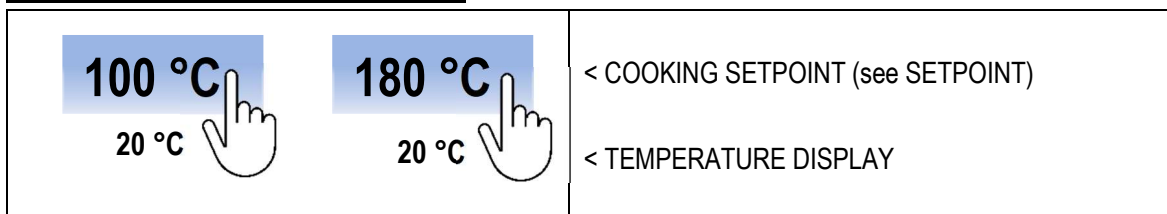

#### SETTING TEMPERATURE SETPOINT



SET THE SETPOINT AS DESCRIBED IN THE CHAPTER

17.2 SETTING COOKING TIME

 <div style="background-color: #ADD8E6; padding: 5px; display: inline-block;">00:45:00</div>  	<p>SELECTING COOKING TIME</p> <p>&lt; COOKING TIME SETPOINT (see SETPOINT)</p> <p>&lt; COOKING TIME COUNTDOWN</p>
--	---

**SELECTING COOKING TIME**

Cooking time  
(at setpoint °C)





Cooking time  
(immediate)



Infinite time

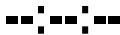

**ATTENTION:** WHEN SELECTING THE INFINITE TIME, PRESS THE KEY INDICATED BELOW TO TERMINATE THE PROGRAM IN PROGRESS.

   <p>00:04:31 ←</p>	<p><b>NOTE:</b> The time elapsed since the beginning of the phase is indicated on the bottom row.</p>
--	---

**SETTING COOKING TIME SETPOINT**

00:45:00

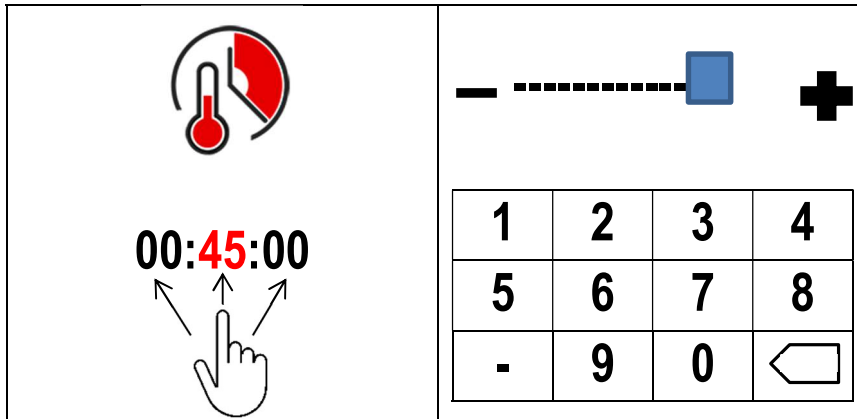

HH:MM:SS

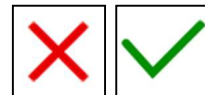

HH: 99 max; MM: 59 max; SS: 59 max

## 18 CREATING PROGRAMS (MULTI-PHASE)

FROM SETTINGS> PROGRAMS> NEW

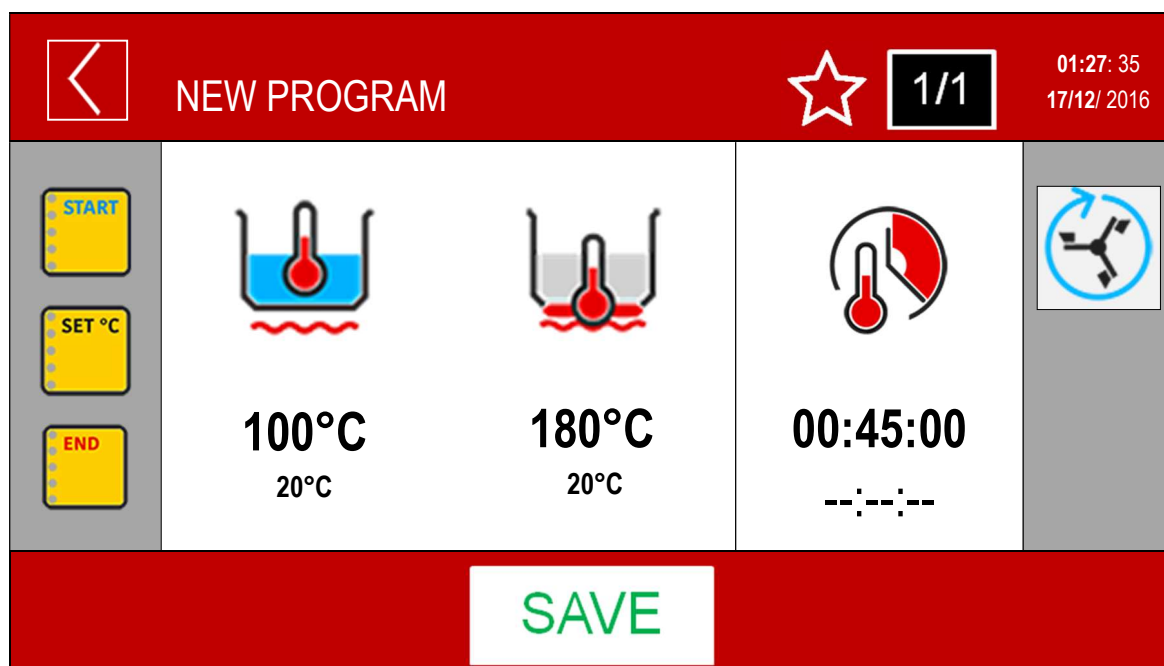

A PROGRAM CAN CONSIST OF 20 PHASES.

THE PARAMETERS ARE CONSTANT WITHIN EACH PHASE. IF A SINGLE VALUE CHANGES, YOU NEED TO CREATE A NEW PHASE!

THE CREATION OF THE PHASE CONSISTS OF ENTERING THE COOKING METHOD, COOKING TIMES, MIXER FUNCTIONS AND WALL HEATING.

IT IS ALSO POSSIBLE TO ENTER (IN EVERY PHASE) 3 MESSAGES PRESENT IN THE LEFT COLUMN. (SEE MESSAGE SETTINGS)

### 18.1 CREATING/DELETING PHASES

ONCE THE PARAMETERS OF PHASE 1 ARE SET, YOU CAN THEN ADD PHASE 2:



AFTER HAVING ADDED AND SET THE PARAMETERS OF PHASE 2, PRESSING ON THE PHASE/PAGE FIELD DISPLAYS THE FOLLOWING SCREEN:

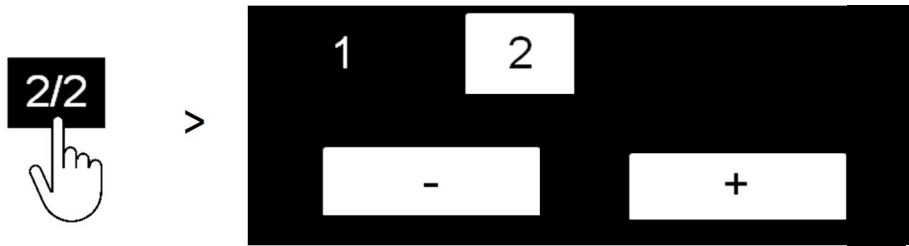

**2** SHOWS THE CURRENT PHASE

**1** RETURNS TO PHASE 1 SETTINGS

**+** ENTERS A NEW PHASE AFTER THE HIGHLIGHTED PHASE

(e.g. if the program consists of 2 phases and I want to insert a phase between 1 and 2, I have to select phase 1 and press the + key, phase 2 becomes 3 and you need to set the parameters for phase 2).

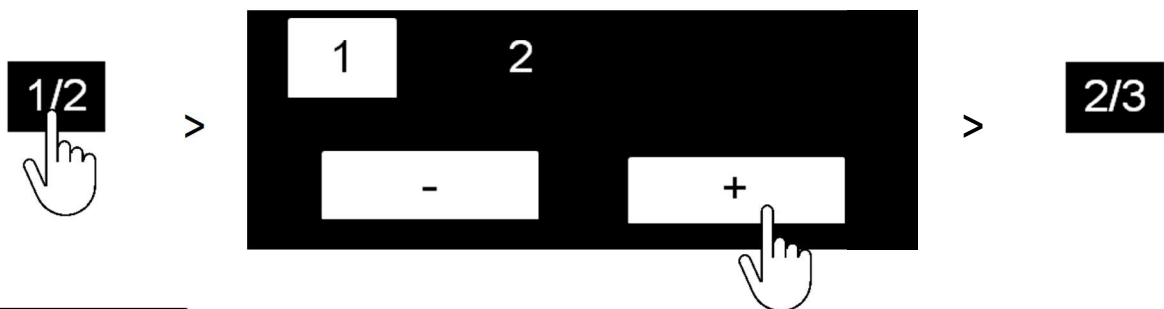

**-** DELETES THE HIGHLIGHTED PHASE AND RENUMBERS THE FOLLOWING PHASES

(e.g. if the program consists of 3 phases and phase 2 is deleted, phase 3 becomes 2)

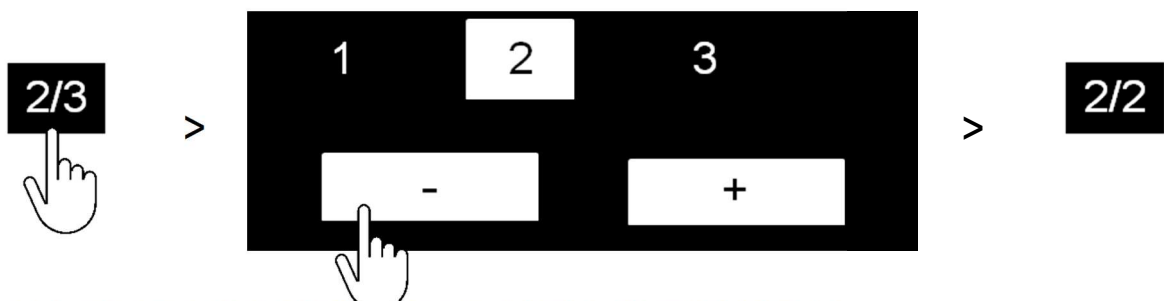

**ATTENTION:** NO CONFIRMATION IS REQUIRED WHEN DELETING PHASES! PRESSING THE KEY **-** IMMEDIATELY DELETES THE CURRENT PHASE!  
PHASE 1 CAN NOT BE DELETED!

18.2 MESSAGE SETTINGS



The following screen appears when selecting the message icon:

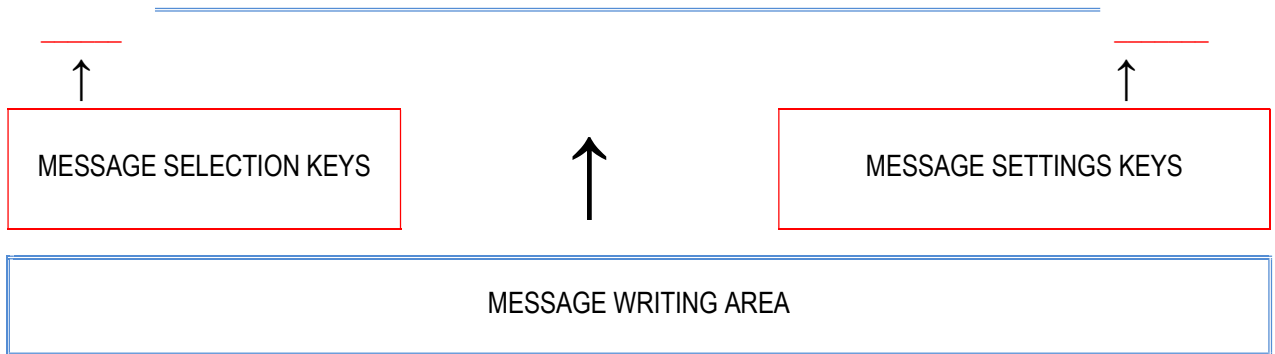
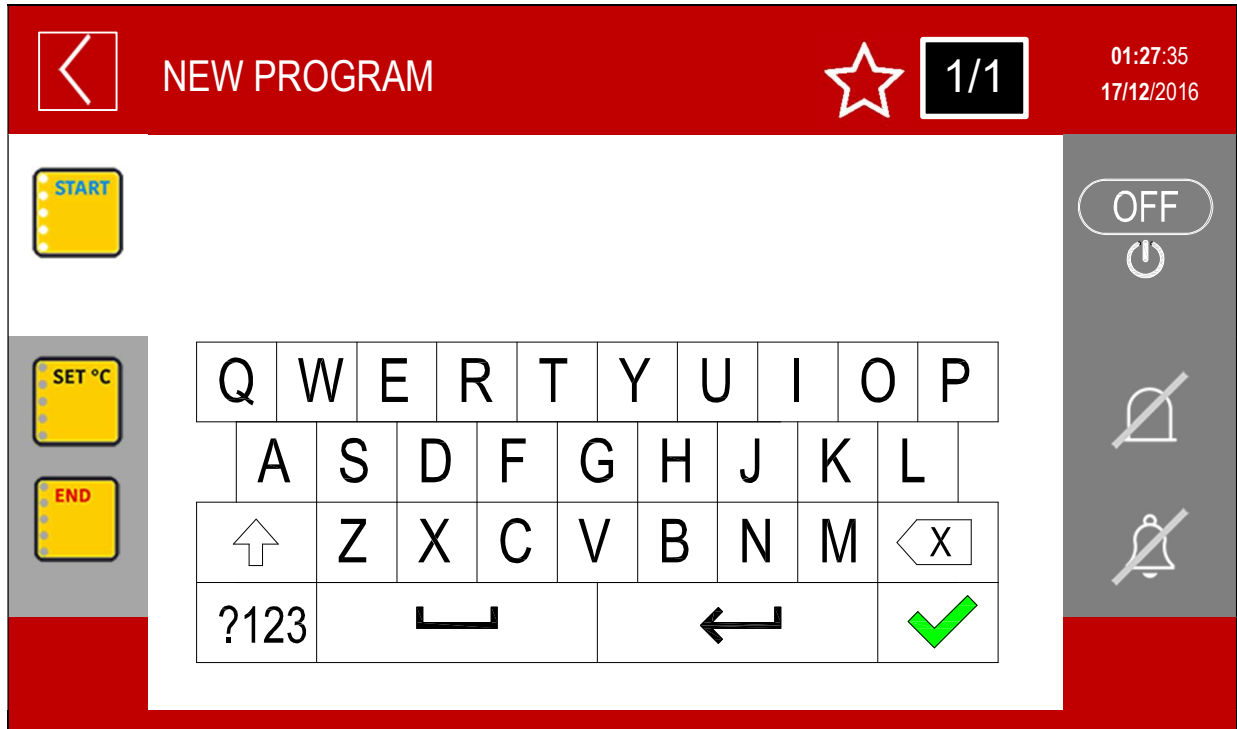









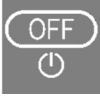





**MESSAGE SELECTION KEYS**

Icon	Description
	MESSAGE AT THE BEGINNING OF THE PHASE
	MESSAGE ON REACHING SETPOINT
	MESSAGE AT THE END OF THE PHASE

**MESSAGE SETTINGS KEYS**

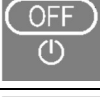
THE KEY ON THE TOP RIGHT TAKES ON THE FOLLOWING FUNCTIONS SPECIFIED IN RELATION TO THE SELECTED MESSAGE (START; SET °C: END)



 <b>START MESSAGE</b>	
Key	Behaviour when program running
	<ul style="list-style-type: none"> <li>No message appears</li> </ul>
	<ul style="list-style-type: none"> <li>The message appears</li> <li>The heating starts at "ON"</li> <li>If the time is set , the countdown begins</li> </ul>
	<ul style="list-style-type: none"> <li>The message appears</li> <li>The heating stays "OFF" until you reply to the message</li> <li>If the time is set , the countdown begins when you reply to the message.</li> </ul>
 <b>MESSAGE ON REACHING SETPOINT</b>	
Key	Behaviour when program running
	<ul style="list-style-type: none"> <li>No message appears</li> </ul>
	<ul style="list-style-type: none"> <li>The message appears</li> <li>Heating keeps the SETPOINT</li> <li>If the time is set , the countdown begins</li> </ul>
	<ul style="list-style-type: none"> <li>The message appears</li> <li>Heating keeps the SETPOINT</li> <li>If the time is set , the countdown begins when you reply to the message.</li> </ul>
 <b>END OF PHASE MESSAGE</b>	
Key	Behaviour when program running
	<ul style="list-style-type: none"> <li>No message appears</li> </ul>
	<ul style="list-style-type: none"> <li>The message appears</li> <li>Heating keeps the SETPOINT</li> <li>When the countdown has ended, it is possible to increase the cooking time or move on to the next phase.</li> </ul>





**ATTENTION** : IF THE MESSAGE IS SET TO OFF, ALL THE SETTINGS DESCRIBED BELOW (FLASHING, BUZZER, AND TEXT) **WILL NOT APPEAR** WHEN THE PROGRAM IS RUNNING!

THE FOLLOWING KEYS HAVE THE SAME FUNCTIONS FOR ALL MESSAGES (START; SET °C; END)

Flashing (optional)

Right key	Behaviour when program running
	<ul style="list-style-type: none"> <li>Flashing not enabled</li> </ul>
	<ul style="list-style-type: none"> <li>When the message appears, the flashing light also switches on. (message frame flashing or external flashing optional)</li> </ul>

Buzzer

Right key	Behaviour when program running
	<ul style="list-style-type: none"> <li>Buzzer not enabled</li> </ul>
	<ul style="list-style-type: none"> <li>When the message appears, the buzzer sounds</li> </ul>

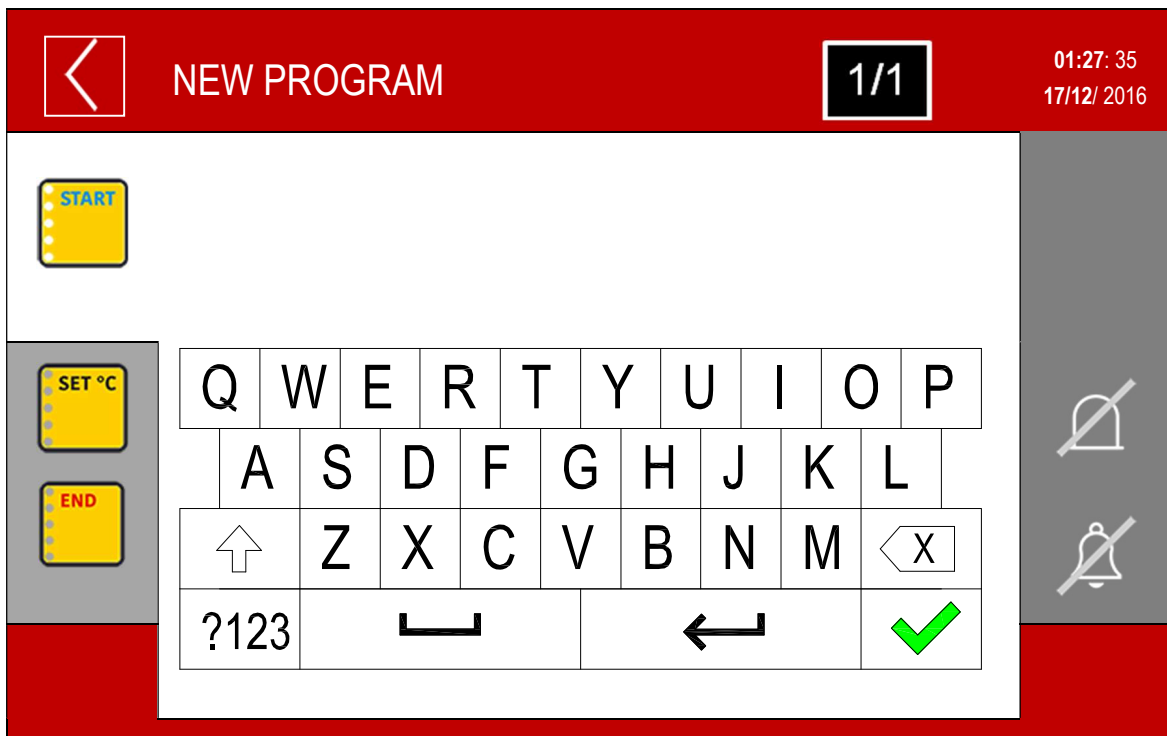
**ENTERING MESSAGE TEXT**

USE THE KEYPAD TO ENTER A DESCRIPTIVE TEXT (MAX 200 CHARACTERS) AND CONFIRM

WITH THE KEY 

AFTER HAVING SET ALL THE VARIABLES WITHIN THE MESSAGE, THE RELATED MESSAGE ICON WILL SHOW WITHIN ALL THE SYMBOLS THAT SUMMARISE THE SETTINGS OF THE MESSAGE ITSELF.

TEXT PRESENT>

BUZZER ENABLED>

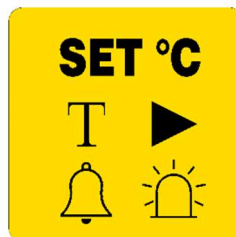

< ACTION TYPE

< FLASHING ENABLED

**ATTENTION:** IF THE MESSAGE IS IN "OFF", IT APPEARS ON A GREY BACKGROUND.

ANY SETTINGS (TEXT, BUZZER, FLASHING) WILL NOT BE CANCELLED FROM MESSAGE SETTING!

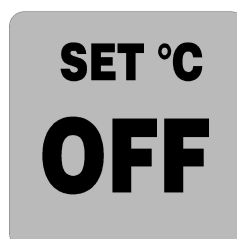

18.3 SAVING A PROGRAM

IF YOU WANT TO ADD THE PROGRAM TO THE LIST OF FAVOURITES, PRESS THE "STAR" SYMBOL.



- Program NOT added to favourites



- Program added to favourites

PRESS THE "SAVE" BUTTON



THE KEYPAD APPEARS TO ENTER THE PROGRAM NAME.

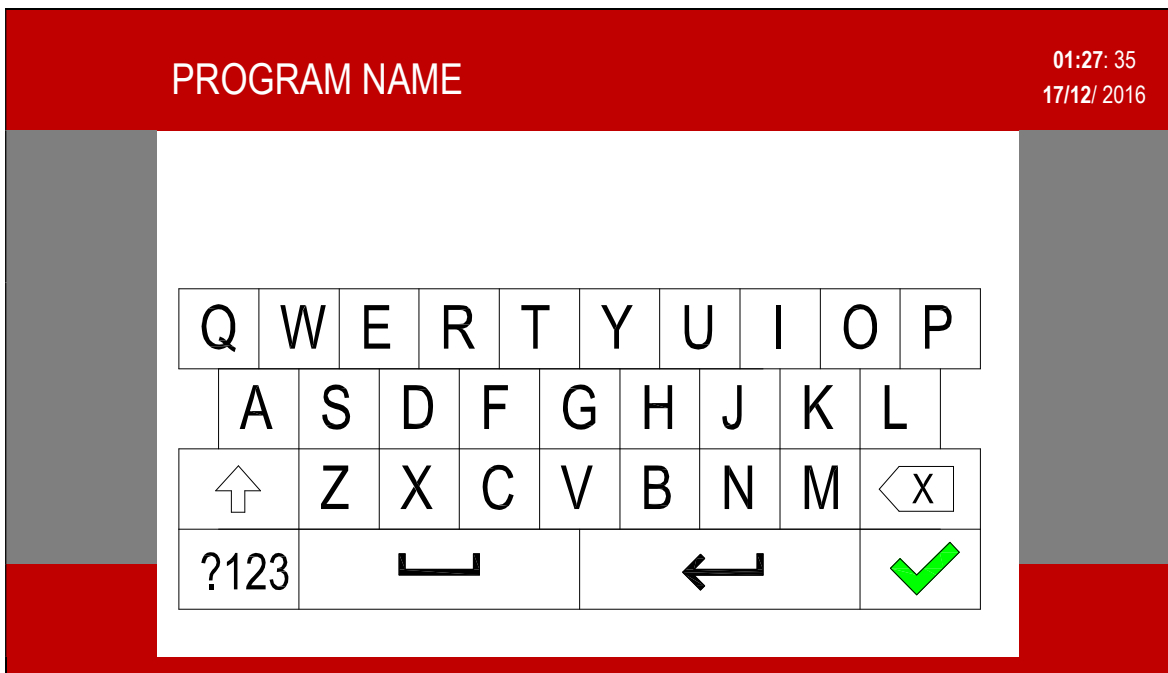

ENTER THE PROGRAM NAME AND CONFIRM WITH THE KEY ✓ .

**ATTENTION** : THE PROGRAM DOES NOT PERFORM A CHECK TO SEE IF A PROGRAM WITH THE SAME NAME ALREADY EXISTS. 2 PROGRAMS WILL BE SAVED WITH THE SAME NAME, WITH THE POSSIBILITY OF RENAMING THEM. (SEE EDITING PROGRAMS)

THE SCREEN APPEARS FOR LINKING THE PROGRAM TO A CATEGORY

---

## 18.4 EDIT/ COPY/ RENAME PROGRAM

---

- FROM SETTINGS> PROGRAMS
- SELECT THE CATEGORY OF THE PROGRAM OR ALL
- SELECT THE PROGRAM THAT YOU WANT TO EDIT.

REFER TO "CREATING MULTIPHASE PROGRAMS" FOR EDITING

ONCE CHANGES HAVE BEEN MADE, PRESS THE SAVE KEY AND THE FOLLOWING SCREEN APPEARS:



SAVE: SAVES THE PROGRAM (NO FURTHER REQUEST)

COPY: A NEW PROGRAM IS CREATED (GIVE THE NAME TO THE PROGRAM AND THE CATEGORY)

RENAME: GIVES A NEW NAME TO THE PROGRAM (SAVING THE CHANGES MADE)

MOVE: MOVES THE PROGRAM TO ANOTHER GROUP (PRESS THE SAVE KEY TO CONFIRM)

## 18.5 DELETING A PROGRAM

- FROM SETTINGS> PROGRAMS
- SELECT THE CATEGORY OF THE PROGRAM OR ALL
- SELECT THE PROGRAM YOU WANT TO DELETE BY PRESSING ON THE NAME OF THE PROGRAM FOR ABOUT 2 SEC.
- A POP-UP WILL BE APPEAR TO CONFIRM PROGRAM DELETION



**CONFIRM DELETION**



**CANCEL DELETION**

## 19 RUNNING A PROGRAM/MANUAL COOKING

### 19.1 RUNNING A PROGRAM/MANUAL COOKING

FROM PROGRAMS> MANUAL

SET ALL THE COOKING PARAMETERS

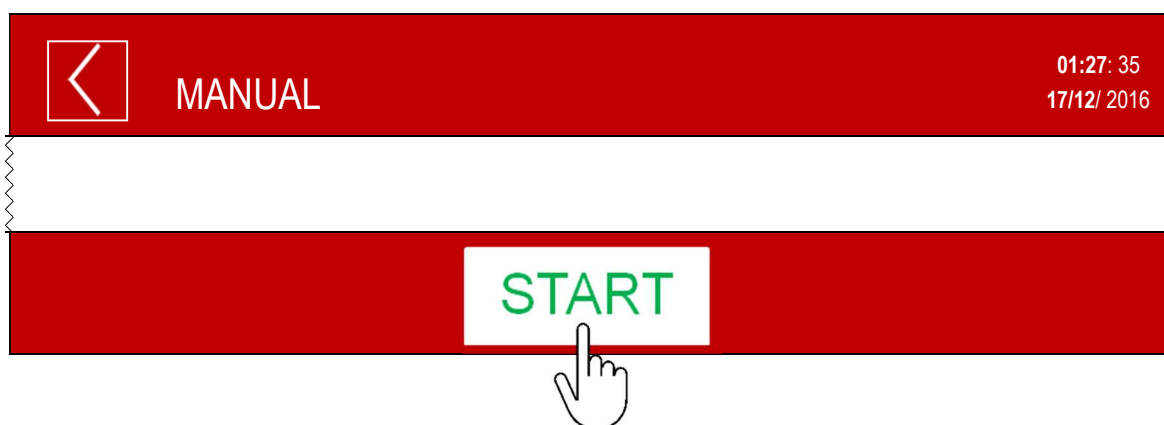

PRESS THE START KEY

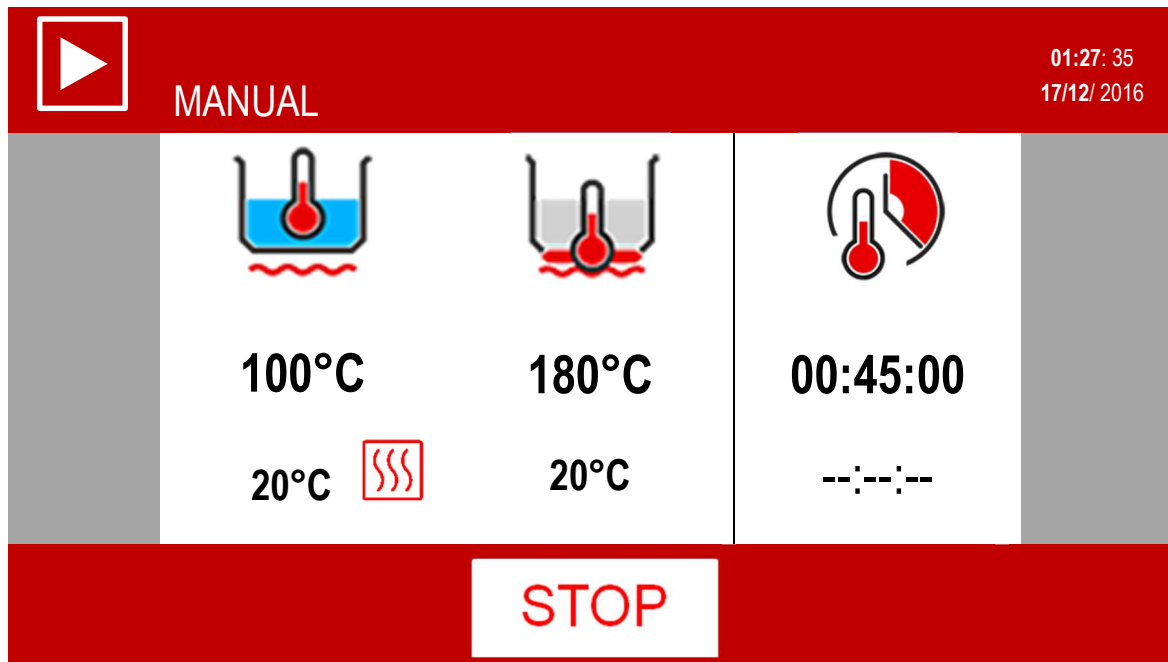

THE SCREEN BECOMES



A SYMBOL APPEARS ON THE SIDE OF THE VALUE READ WITH THE FOLLOWING MEANINGS:

	<ul style="list-style-type: none"> <li>• HEATING IN OPERATION</li> </ul>
	<ul style="list-style-type: none"> <li>• MINIMUM HEATING</li> </ul>
	<ul style="list-style-type: none"> <li>• HEATING OFF AS SETPOINT REACHED OR FOR WAITING (L COLUMN ICONS)</li> </ul>

WHEN RUNNING THE PROGRAM YOU CAN CHANGE THE TEMPERATURE AND TIME SETPOINT BY PRESSING IN THE FIELD CORRESPONDING TO THE SET VALUES FOR ABOUT 2 sec. .

**IT IS NOT POSSIBLE TO CHANGE THE COOKING METHOD AND TIME!!**

## 19.2 END OF COOKING

EITHER WAIT UNTIL END OF COOKING TIME (IF TIME SET) OR PRESS THE STOP KEY.

IF THE SET TIME IS  (INFINITE) OR  (BASKETS), COOKING/HEATING CAN ONLY BE ENDED BY PRESSING THE STOP KEY!

KEY!

## 20 RUNNING PROGRAMS (MULTI-PHASE)

### 20.1 RUNNING PROGRAMS (MULTI-PHASE)

FROM PROGRAMS> SELECT THE PROGRAM THAT YOU WANT TO RUN FROM THE FOLDER: ALL; CATEGORY (MEAT, SAUCES, ETC) OR FAVOURITES

PRESS THE START KEY

**NOTE 1)**

WHEN RUNNING THE PROGRAM YOU CAN CHANGE THE TEMPERATURE AND TIME SETPOINT (ONLY IN THE PHASE IN WHICH THE PROGRAM IS CURRENTLY RUNNING) BY PRESSING IN THE FIELD CORRESPONDING TO THE SET VALUES FOR ABOUT 2 sec. .

**IT IS NOT POSSIBLE TO CHANGE THE COOKING METHOD AND TIME!!**

**NOTE 2)**

YOU CAN MOVE ON TO THE NEXT PHASE (WITHOUT WAITING FOR THE PHASE IN PROGRESS TO FINISH) BY PRESSING THE "PROGRAM PHASE" FIELD.



APPEARS:



x1 IT RETURNS TO THE PHASE IN PROGRESS



x2 IT PASSES TO THE NEXT PHASE.  
**ATTENTION:** IF IT IS THE LAST PHASE, THE PROGRAM FINISHES!

**NOTE 3)**

IF A PROGRAM HAS A PHASE SET WITH AN INFINITE TIME, THE MOVE TO THE NEXT STAGE IS ACHIEVED BY PRESSING THE KEY TO THE SIDE OF THE TIME SYMBOL

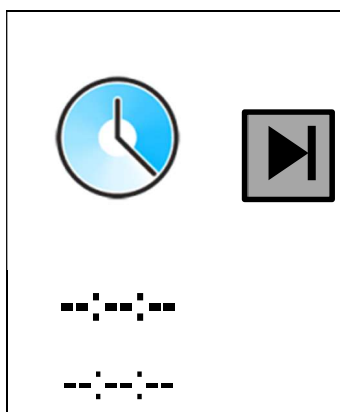

Press the key to move on to the next phase

The time elapsed since the beginning of the phase is shown on the bottom row.

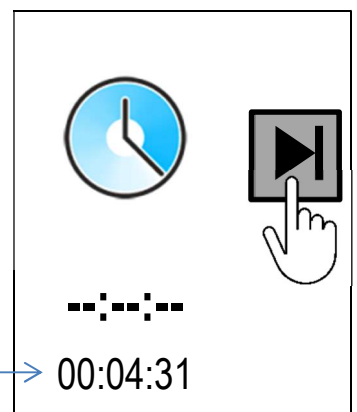

**NOTE 4)**

IF YOU ARE RUNNING A PROGRAM WITH ACTIVE MESSAGES, WHEN THE MESSAGE APPEARS, THE OPERATOR:

**CAN** PRESS THE BUZZER OR TURN OFF THE FLASHING (IF PRESENT IN THE MESSAGE)



**MUST** CONFIRM THE OPERATION REQUESTED TO CONTINUE WITH THE PHASE OR TO MOVE ON TO THE NEXT PHASE.

**NOTE 5)**

IF THE PROGRAM HAS THE ACTIVE MESSAGE "**END**" AT THE END OF THE COOKING TIME, THE FOLLOWING MESSAGE APPEARS: END THE PHASE?

IF YOU PRESS "**YES**", IT MOVES ON TO THE NEXT PHASE;

IF YOU PRESS "**NO**", THE FOLLOWING KEYS APPEAR:

 	key to move on to the next phase
<b>00:45:00</b> 00:00:11 	key to increase the time (+ 1 minute each time the key is pressed)

The bottom row indicates the time passed since the cooking time elapsed.

AT THIS POINT IT IS NO LONGER POSSIBLE TO CHANGE THE TIME SETPOINT!

IN ORDER TO EXTEND THE COOKING:

- EITHER YOU CHECK THE TIME PASSED ON THE LOWER ROW AND GO TO THE NEXT STEP BY PRESSING THE KEY ABOVE;
- OR PRESS THE +1 KEY (THE NUMBER OF TIMES CORRESPONDING TO THE DESIRED NUMBER OF MINUTES). THE COUNTDOWN WILL BE DISPLAYED ON THE BOTTOM ROW AND THE KEY ABOVE WILL DISAPPEAR. IT IS NOT POSSIBLE TO DECREASE THE MINUTES SET. IF YOU MAKE A MISTAKE AND SET TOO MANY MINUTES, YOU HAVE TO MOVE ON TO THE NEXT PHASE AS DESCRIBED IN NOTE 2.



ONCE THE TIME HAS RUN OUT, THE FOLLOWING MESSAGE WILL REAPPEAR: END THE PHASE?

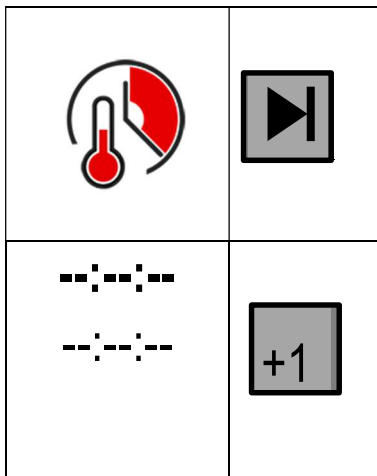

---

## 20.2 END OF PROGRAM

---

EITHER WAIT FOR THE END OF PROGRAM OR PRESS THE STOP KEY (+ CONFIRM).

IF THE SET TIME IS  (INFINITE) OR  (BASKETS), COOKING/HEATING CAN ONLY BE ENDED BY PRESSING THE STOP KEY!

## 21 COOKING WITH DELAY TIMER

After having chosen the program to run,

press the button  to access the settings for cooking with delay timer.

It is possible to set the delayed start in two ways:

Top row:

setting the start date and time: set the hour and minutes, and, if necessary, the day (with a maximum of 7 days in advance).

Bottom row:

setting delayed start: starting from the current time and date, set the hour and minutes, and if applicable the day(s) delayed (with a maximum of 7 days in advance).

In automatic, when setting in one mode or the other, the other row will also be updated. (if the start time and date are set, the delayed time will be updated, and vice versa).

To exit without saving, press the key .

Press the START key to confirm.

The display shows the time and date when it will start, and the bottom row shows the time remaining until it starts.

To cancel the delayed start, press the STOP button.

**Attention:** check that there are no lights in the left column (e.g.  pan out of position), otherwise the cooking with delay timer will NOT be carried out.

## 22 FILLING PAN WITH H2O

### 22.1 FILLING THE PAN WITH H2O USING A LITRE-COUNTER DEVICE

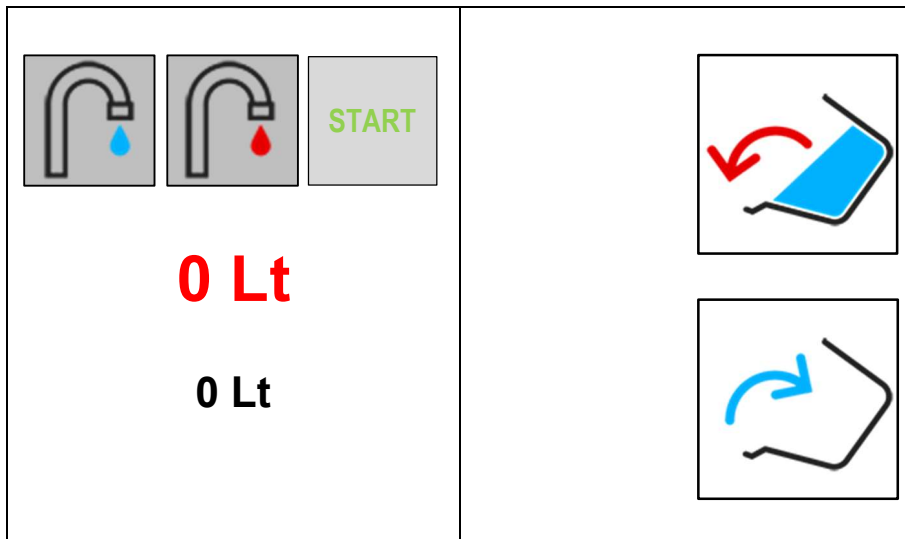

Select hot or cold water. Press on the Lt. Field

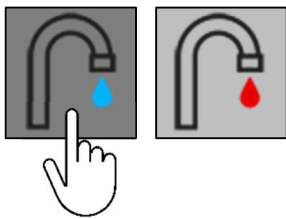

Set the number of litres you want to add and confirm with

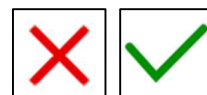
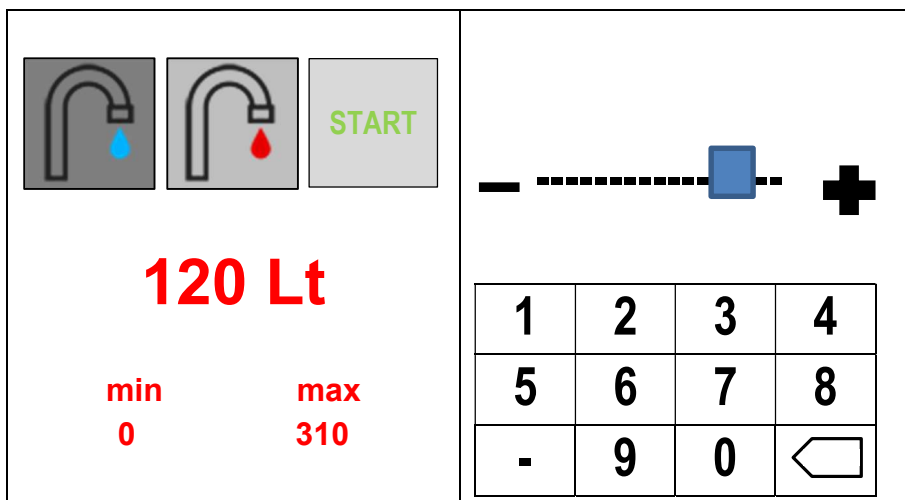

Press the "START" key

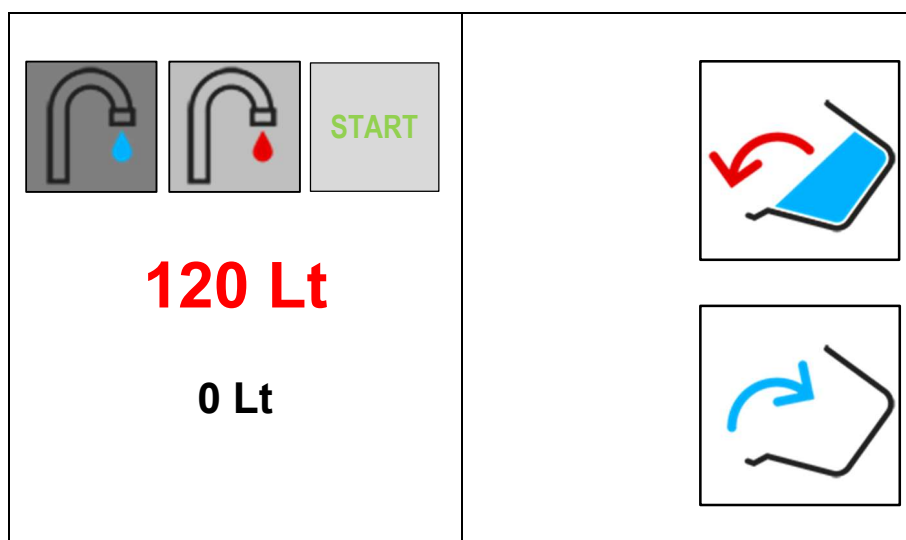

**120 Lt** litres set

**10 Lt** litres added

If you want to stop filling with water before the number of litres set is reached, press the "START" key

22.2 MANUALLY FILLING THE PAN WITH H2O

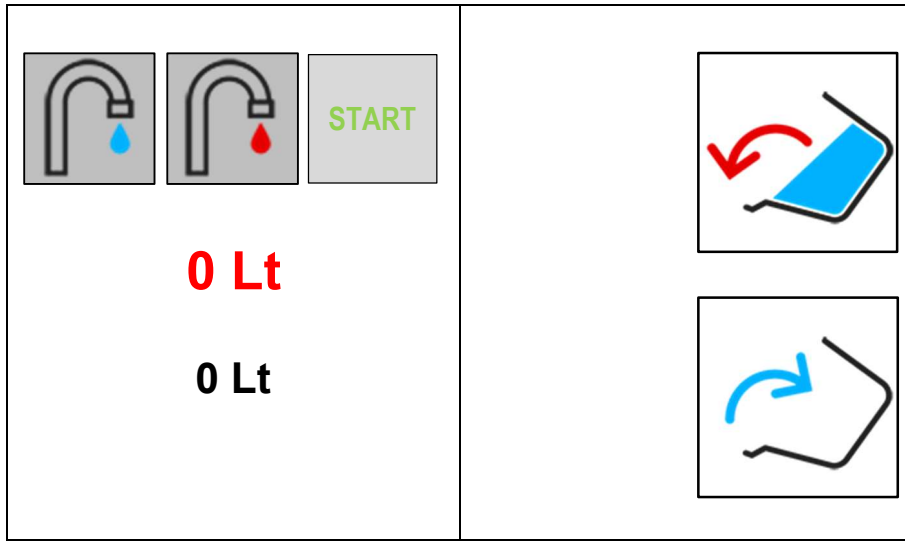

select hot or cold water

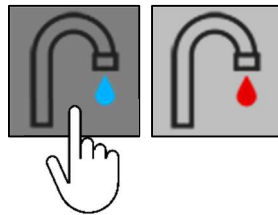

Keep the "START" key pressed down for the desired number of litres



**0 Lt**

**10 Lt** litres added

## 23 COOKING WITH BASKETS (MOD.DBR ..-C)

### 23.1 SELECTING THE COOKING METHOD

Select the required cooking method: "boiling"



Set the desired temperature value

### 23.2 SELECTING COOKING TIME

Select the cooking time (baskets)



Set the desired time value

### 23.3 FITTING BARS AND BASKETS

Open the lid completely



Insert the bar into the side housings

Press the key

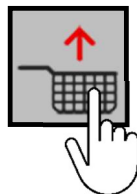

Wait until the bar is completely lifted and hook the baskets, previously loaded with the product to be cooked, to the bar.

**ATTENTION:**

Use baskets appropriate for the cooking method.

Baskets for boiling



---

**23.4 STARTING HEATING**

---

PRESS THE START KEY



THE SCREEN BECOMES

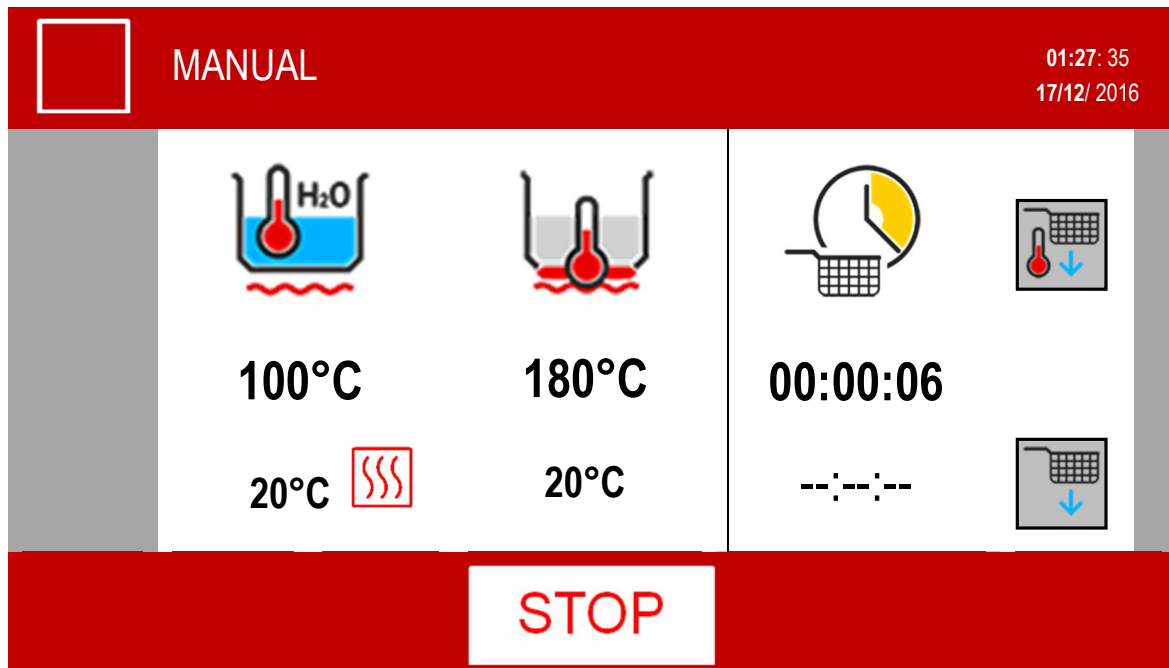

## 23.5 IMMERSING THE BASKETS

The baskets can be immersed in the cooking pan in the following 2 ways:

### Baskets immersed upon reaching the SETPOINT temperature

This is recommended when the cooking liquid (water or oil) is not yet at the required temperature, or when a precise temperature of the cooking liquid is required, before immersing the basket.

When the following key

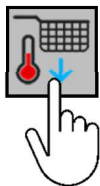

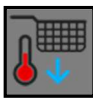
becomes dark grey when pressed  = lowering enabled at SETPOINT temperature.

When the key is pressed again it turns light grey and the function is disabled!

When the SETPOINT temperature is reached, a message appears with a countdown for basket lowering,

at the end of which the key appears  (in dark grey) until the baskets are automatically lowered to the cooking position.



### Baskets immersed immediately

When the following key

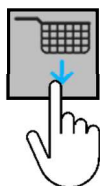

turns grey and the baskets are lowered immediately to the cooking position.

---

## 23.6 COOKING TIME (BASKET IMMERSION)

---

Once the baskets have reached the cooking position, the countdown of the set cooking time starts.

Before the cooking time runs out (about 10 sec.), a message appears with the countdown for basket

lifting, at the end of which the key



appears (in dark grey) until the baskets are automatically lifted to the loading/unloading position.

At this point it is possible to empty the cooked product.

If you want to run a new cycle, load the new product and repeat the cooking cycle as described above.

### **ATTENTION:**

The countdown of the cooking time will NOT start if the heating has not been started!!

The key on the function bar must be "STOP".



---

## 23.7 END OF COOKING/HEATING

---

At the end of the cooking cycles, switch off the heating by pressing the STOP button.

Remove the baskets from the bar and the bar from the supports and press the button  to bring the lifting system back into the rest position.

## 24 MOVING THE PAN

To move the cooking vessel, keep pressed the corresponding key on the display or external keypad.  
The keys on the display are disabled when the pan tilting limits are reached.

With a completely horizontal pan = enabled only

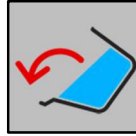

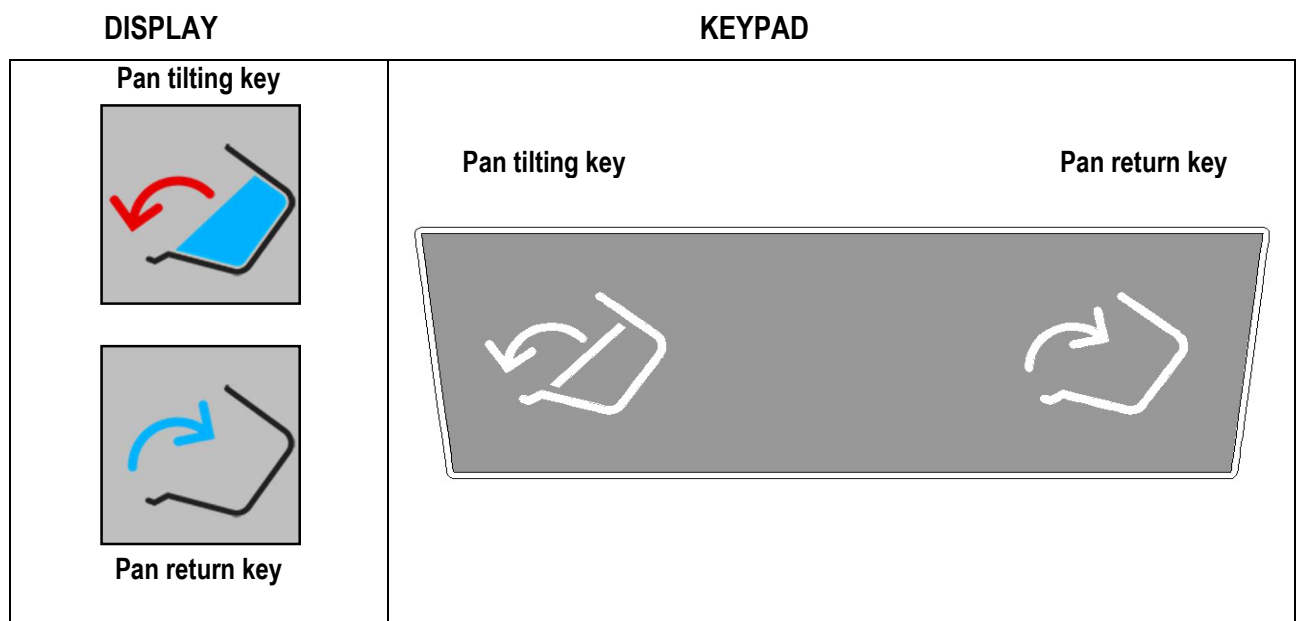
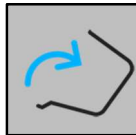

With a tilted pan = enabled only



As tilting prevents the heating and mixing functions, whenever the pan is not in a horizontal position, the

icon  appears.

Any messages that prevent pan movement appear in the left column.

Icon	Description
	Pan movement not allowed
	<u>Request</u> to completely open the lid (for pan movement)
	<u>Request</u> to turn the tap (for pan movement)

To return the pan to the horizontal position, press and hold the corresponding key, **until the icon**

 disappears.

**ATTENTION:** The presence of the icon  prevents the cooking functions of the machine.

## 25 CLEANING AND CARE

### 25.1 GENERAL INFORMATION

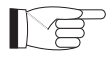

Do not use aggressive substances or abrasive detergents when cleaning stainless steel parts.



Avoid using iron scourers on steel parts as rust formation may occur. For the same reason avoid contact with ferrous materials.

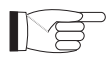

No sandpaper or abrasive paper should be used during cleaning. In special cases, pumice stone may be used in powder form.



In the event of particularly resistant dirt, we recommend the use of abrasive sponges (e.g. Scotch-Brite).

### 25.2 DAILY CLEANING



**Always wear protective clothing required by current regulations.**



For safety reasons, clean the machine when it is cold and off (with the emergency button pressed) (or on stand-by if cooking with delay timer).  
When cleaning the appliance **never spray water directly in order not to cause infiltration and damage to the parts.**



**Never use water jets in the flue in gas versions.**

Clean the pan with water and detergent, rinse well and dry thoroughly with a soft cloth

Clean the outside with a sponge soaked in hot water and a suitable detergent readily available on the market.

Always rinse well and dry with a soft cloth.



**Be careful not to damage the lid seal.**  
**Clean the seal with NON-abrasive liquid detergent.**

---

### 25.3 PRECAUTIONS IN CASE OF PROLONGED INACTIVITY

---

If the appliance has been inactive for a prolonged period of time (holidays, seasonal work...), clean well, remove any residue and ensure it is dry.

Leave the lid open so that air can circulate inside the pan.

The room must be sufficiently ventilated.



**Disconnect all water, electricity and gas supplies.**

---

### 25.4 PRECAUTIONS IN CASE OF MALFUNCTION

---

- Should malfunctions occur during use, switch off the appliance immediately and disconnect or stop all supplies (gas and water).
- Request assistance from technical support or a qualified technician.



**The manufacturer assumes no responsibility or warranty commitment for injuries and damage due to non-compliance with the instructions or any installation or maintenance that does not comply with safety standards.**

The same applies in case of improper use of the appliance by the operator.

## 26 MAINTENANCE

### 26.1 MAINTENANCE OF THE APPLIANCE



**All maintenance work must only be performed by a specialist technical service centre!**

- In order to keep the appliance working efficiently, it is advisable to perform annual maintenance, which includes checking the status of components subject to wear and tear (pipes, etc.).
- It is advisable to replace any worn components during maintenance, in order to avoid further call outs and unexpected issues and faults with the appliance.
- Therefore, it is recommended to sign a maintenance contract with a reliable technical support centre.

### 26.2 PERIODIC MAINTENANCE

Periodic inspections will minimise machine downtime and increase operating efficiency.

The following points must be checked:

Periodic inspections will minimise machine downtime and increase operating efficiency.

The following points must be checked:

#### **BY OPERATOR**

##### DAILY CHECKS

- 1. Thoroughly clean the machine daily**

##### QUARTERLY CHECKS

- 2. Check the following are undamaged and intact:**
  - Screen controls, switches, warning lights.
  - Emergency button:

**Contact technical support if they are damaged.**



**BY SERVICE TECHNICIAN****For each operation:**

- Carefully close all the panels. .
- The inside of the appliance should be kept clean.
- Electrical wiring should be kept securely connected and in good condition.

**ANNUAL CHECKS / ACTION**

1. Check coupling panels, must be perfectly closed with all the screws.
2. Check the sealing water system (load tap water).
3. Check that terminals connections of electrical parts are well fastened. Clean electrical parts .

## 27 DISPLAY MESSAGES

Message	Meaning	Solution
	<p>Safety thermostat has been triggered</p> <p>The safety thermostat can be disarmed during transport without any issues.</p>	<p><b>Reset the thermostat from the lower panel on the right hand side, by pressing firmly on the red thermostat key.</b></p> <p>If the thermostat is triggered again, contact the support centre.</p>
<p><b>GAS</b></p> 	<p>Insufficient gas pressure. It is not possible to start cooking.</p>	<p>Verify that gas is supplied and that the pressure is sufficient. <b>Contact the support centre.</b></p>
<p><b>!! BLOCK GAS DEVICE !! PRESS **RESET**</b></p> 	<p>If a cooking phase has started and insufficient gas pressure has been detected on 4 consecutive occasions or there is a fault on the flame detection system, the central unit will be interrupted.</p>	<p>Press "RESET". After 3 RESET attempts, the message below appears.</p>
<p><b>!! GAS SYSTEM ANOMALY!! CONTACT TECHNICAL ASSISTANCE</b></p>	<p>Problem with the gas system: gas central unit fuses, gas solenoid valve, spark plugs and pilot light plug.</p>	<p>Contact technical support.</p>
<p><b>PROBES ERROR</b></p>	<p>One or more of the appliance's sensors/probes are faulty (or not connected). Cooking methods that use these sensors/probes will be disabled (light grey) until they are repaired.</p>	<p>Contact technical support.</p>
<p><b>INTERNAL ERROR</b></p>	<p>Connection error between the relay board and keypad board</p> <p>System board error.</p>	<p><b>Switch the appliance off, and switch back on after two minutes, if the problem persists, call a technician</b></p>



<b>BLACK OUT ERROR</b>	t.b.d	
<b>INVERTER ERROR</b>	Connection error between relay board and inverter	Contact technical support.
<b>EXTERNAL MEMORY ERROR</b>	SD memory card not available.	Contact technical support.
<b>OUTPUT CONFIGURATION ERROR</b>	PROGRAMMING ERROR. Dual output assignment!!	Contact technical support.