

# AXIOM® 0/6 TWIN (6 Lower Warmers)

Height: 20.5" Width: 30.6" Depth: 22.5"  
(52.1cm) (77.7cm) (57.2cm)



- Adjusts automatically to varying water pressure
- Automatic warmer shut-off
- For high lime areas, BrewLOGIC® technology calculates flow rate and adjusts brew time to maintain consistent pot levels
- Electronic diagnostics and built-in tank drain make service easier
- Large 200oz. (5.9L) tank provides back-to-back brewing capacity
- Ensure coffee quality with programming for brew level, cold brew lock-out and tank temperature, set easily from the front of the machine
- Coffee extraction controlled with programmable pre-infusion, pulse brew and digital temperature precision
- All stainless steel construction
- Energy-saver mode reduces tank temperature during idle periods
- Hot water faucet
- SplashGard® funnels deflect hot liquids away from the hand
- Six individually controlled warming stations
- Twin brew head system
- PROP 65 Warning Decal included in packaging with equipment
- Servers not included unless otherwise noted

Agency:

Server(s) sold separately



## Specifications

**Product #:** 38700.0015

**Water Access:** Plumbed

**Finish:** Stainless

**Funnel:** Stainless Steel

**Faucet:** Upper

**Warmers:** Six Lower

**Legs:** 4" Black Legs

## Additional Features

DBC

## Electrical & Capacity

Volts*	Amps	Watts	Cord Attached	Plug Type	8oz cups/hr 236ml cups/hr	Input H <sub>2</sub> O Temp.	Phase	# Wires plus Ground	Hertz
120/208-240	27.9	6700	No	-	240	60°F (15.5°C)	1	3	60

\*When a BUNN is machine rated 120/208-240V, 120/208V or 120/240V, the higher voltage is the supply voltage needed to power the machine. The 120V is there to supply power to some components rated 120V in the machine, but it is not the supply voltage and would not power the machine if the machine is marked with the before mentioned ratings.

## Plumbing Requirements

PSI	kPa	Fitting Supplied	Water Flow Required (GPM)
20-90	138-621	1/4" Male Flare Fitting	-

## CAD Drawings

2D	Revit	KLC
●		

**WARNING:** This product can expose you to chemicals including Bisphenol A (BPA), which is known to the State of California to cause birth defects or other reproductive harm. For more information go to [www.P65Warnings.ca.gov](http://www.P65Warnings.ca.gov)



BUNN® reserves the right to change specifications and product design without notice. Such revisions do not entitle the buyer to corresponding changes, improvements, additions or replacements for previously purchased equipment. For most current specifications and other info visit [bunn.com](http://bunn.com).

Last Updated:  
03/30/2023

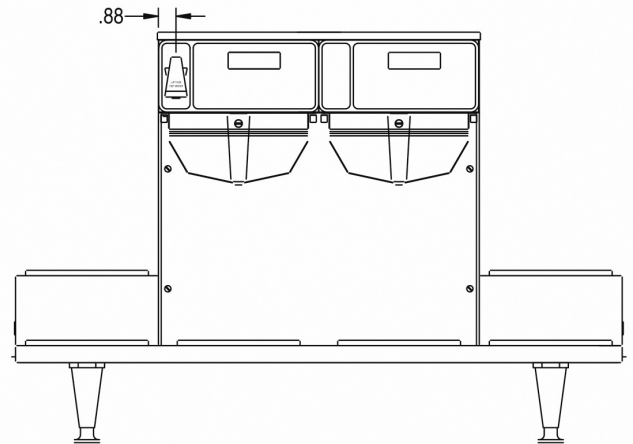
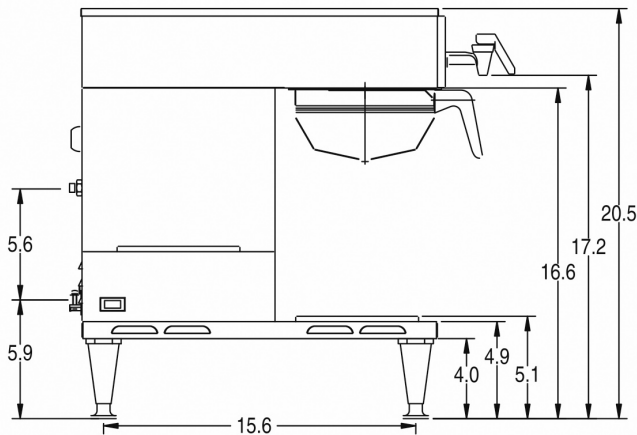
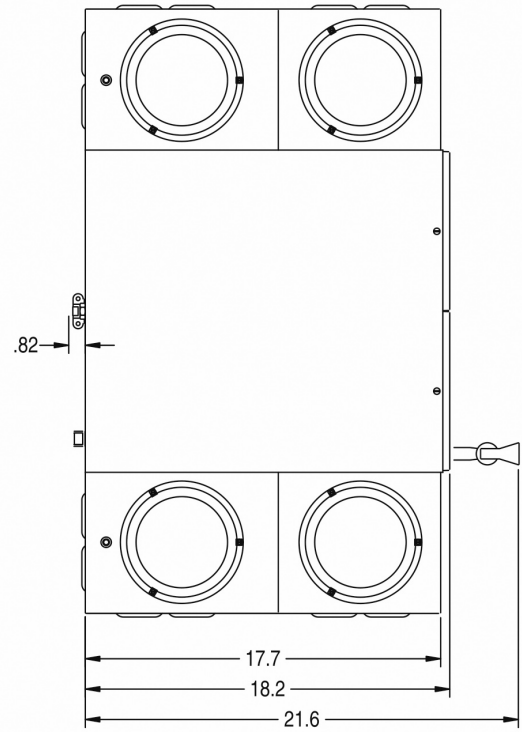
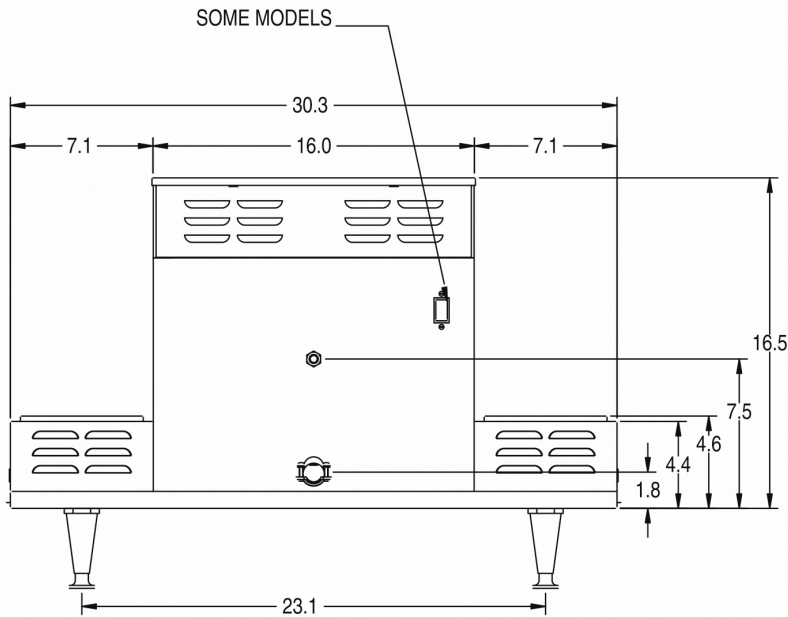

	Unit			Shipping				
	Height	Width	Depth	Height	Width	Depth	Weight	Volume
English	20.5 in.	30.6 in.	22.5 in.	24.1 in.	25.5 in.	33.5 in.	74.000 lbs	11.926 ft³
Metric	52.1 cm	77.7 cm	57.2 cm	61.3 cm	64.8 cm	85.1 cm	33.566 kgs	0.338 m³



BUNN® reserves the right to change specifications and product design without notice. Such revisions do not entitle the buyer to corresponding changes, improvements, additions or replacements for previously purchased equipment. For most current specifications and other info visit [bunn.com](http://bunn.com).

Last Updated:  
03/30/2023

# Related Products & Accessories: AXIOM® 0/6 TWIN (6 Lower Warmers)(38700.0015)



FUNNEL W/DECAL,PPK  
NAR BLK(SM)

Product #: 02774.0011



FUNNEL W/DECAL,PPK  
NAR BLK(LG)

Product #: 04274.0012



FILTERS,REGULAR1M  
500/2 50/CL

Product #: 20115.0000



FILTERS,C GOURMET  
500/2 50/CL

Product #: 20157.0001



FUNNEL ASSY, SST-BLK  
HDL(7.12)

Product #: 20216.0000



FUNNEL ASSY,SST-BLK  
HDL(7.62)

Product #: 20217.0000



FUNNEL ASSY, SST-PP  
BLK HNDL

Product #: 29151.0000



FUNNEL ASSY,SST-PP  
ORANGE HDL

Product #: 29151.0001



WATER FILTER,  
EQHP-10L

Product #: 39000.0001



WATER FILTER,  
EQHP-10

Product #: 39000.0004



WATER FILTER, SCALE-  
PRO

Product #: 39000.0010



SYSTEM, WQ-55(2)5L

Product #: 56000.0001



SYSTEM, WQ-55(2)5

Product #: 56000.0004



SYSTEM, WQ-SCALE-  
PRO.X-150(15)

Product #: 56000.0010



SYSTEM, WEQ-10(1.5)5L

Product #: 56000.0024



SYSTEM, WEQ-10(1.5)5

Product #: 56000.0027



SYSTEM, WEQ-SCALE-  
PRO.X

Product #: 56000.0033



CARTRIDGE, WQ-55(2)5L

Product #: 56000.0101



CARTRIDGE, WQ-55(2)5

Product #: 56000.0104



CARTRIDGE, WQ-  
SCALE-PRO.X-150(15)

Product #: 56000.0110



BUNN® reserves the right to change specifications and product design without notice. Such revisions do not entitle the buyer to corresponding changes, improvements, additions or replacements for previously purchased equipment. For most current specifications and other info visit [bunn.com](http://bunn.com).

Last Updated:  
03/30/2023

Related Products & Accessories: AXIOM® 0/6 TWIN (6 Lower Warmers)(38700.0015)



CARTRIDGE, WEQ-SCALE-PRO.X

Product #: 56000.0120



CARTRIDGE, WEQ-10 (1.5)5L

Product #: 56000.0121



CARTRIDGE, WEQ-10 (1.5)5

Product #: 56000.0122



BUNN® reserves the right to change specifications and product design without notice. Such revisions do not entitle the buyer to corresponding changes, improvements, additions or replacements for previously purchased equipment. For most current specifications and other info visit [bunn.com](http://bunn.com).

Last Updated:  
03/30/2023

# Serving & Holding Options: AXIOM® 0/6 TWIN (6 Lower Warmers)(38700.0015)



EASY POUR®,(BLK) 1/CS  
Product #:06100.0101



EASY POUR®,(BLK) 2/CS  
Product #:06100.0102



EASY POUR®,(BLK) 3/CS  
Product #:06100.0103



EASY POUR®,(BLK) 6/CS  
Product #:06100.0106



EASY POUR®,(BLK) 12/CS  
Product #:06100.0112



EASY POUR®,(BLK) 24/CS  
Product #:06100.0124



EASY POUR®,(ORN) 1/CS  
Product #:06101.0101



EASY POUR®,(ORN) 2/CS  
Product #:06101.0102



EASY POUR®,(ORN) 3/CS  
Product #:06101.0103



EASY POUR®,(ORN) 24/CS  
Product #:06101.0124



DECANTER, GLASS-BLK 12C 24/CS  
Product #:42400.0024



DECANTER, GLASS-BLK 12CUP 1PK  
Product #:42400.0101



DECANTER, GLASS-BLK 12C 3/CS  
Product #:42400.0103



DECANTER, GLASS-ORN 12C 24/CS  
Product #:42401.0024



DECANTER, GLASS-ORN 12 CUP 1PK  
Product #:42401.0101



DECANTER, GLASS-ORN 12C 3/CS  
Product #:42401.0103



BUNN® reserves the right to change specifications and product design without notice. Such revisions do not entitle the buyer to corresponding changes, improvements, additions or replacements for previously purchased equipment. For most current specifications and other info visit [bunn.com](http://bunn.com).

Last Updated:  
03/30/2023