



T&S BRASS AND BRONZE WORKS, INC.

2 Saddleback Cove / P.O. Box 1088
Travelers Rest, SC 29690

Model No.

B-0233-02

Item No.

Travelers Rest, SC: 800-476-4103 • Simi Valley, CA: 800-423-0150 • Fax: 864-834-3518 • www.tsbrass.com

This Space for Architect/Engineer Approval

Job Name _____ Date _____

Model Specified _____ Quantity _____

Customer/Wholesaler _____

Contractor _____

Architect/Engineer _____

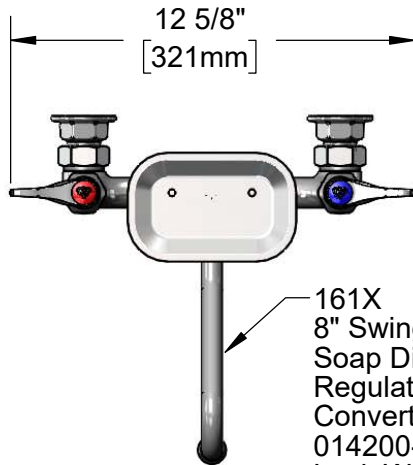

161X
8" Swing Nozzle w/
Soap Dish & Stream
Regulator Outlet
Converts to Rigid w/
014200-45
Lock Washer (Included).



ADA Compliant

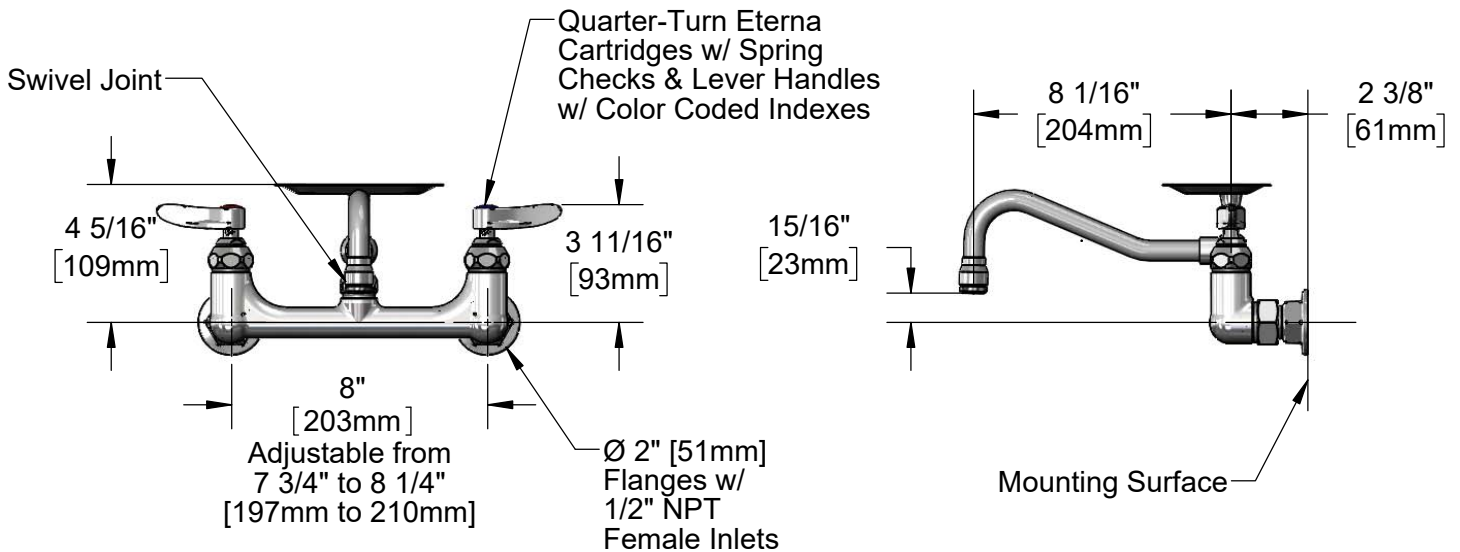

Product Specifications:

8" Wall Mount Mixing Faucet, Quarter-Turn Eterna Cartridges w/ Spring Checks, Lever Handles, 8" Swing Nozzle w/ Stream Regulator Outlet, Soap Dish and 1/2" NPT Female Inlets

Product Compliance:

ASME A112.18.1 / CSA B125.1
NSF 61 - Section 9
NSF 372 (Low Lead Content)
ANSI A117.1 (ADA)



T&S BRASS AND BRONZE WORKS, INC.

2 Saddleback Cove / P.O. Box 1088
Travelers Rest, SC 29690

Model No.

B-0233-02

Item No.

Travelers Rest, SC: 800-476-4103 • Simi Valley, CA: 800-423-0150 • Fax: 864-834-3518 • www.tsbrass.com

ITEM NO.	SALES NO.	DESCRIPTION
1	B-LT	Stream Regulator Outlet
2	001043-45	Washer
3	B-SD	Soap Dish
4	009538-45	Swivel Washer
5	011429-45	Swivel Sleeves (2)
6	001074-45	O-Ring
7	161X	8" Swing Nozzle w/ Soap Dish & Stream Regulator Outlet
8	018506-19NS	Blue Button Index, Press-in
9	000925-45	Lab Handle Screw
10	001638-45NS	Lever Handle (New Style)
11	002711-40NS	Quarter-Turn Eterna Cartridge w/ Spring Check, Handle, Blue Index & Screw, LTC
12	012442-40NS	Quarter-Turn Eterna Cartridge w/ Spring Check, LTC
13	001019-45	Coupling Nut Washer
14	00AA	1/2" NPT Female Eccentric Flange
15	002712-40NS	Quarter-Turn Eterna Cartridge w/ Spring Check, Handle, Red Index & Screw, RTC
16	012443-40NS	Quarter-Turn Eterna Cartridge w/ Spring Check, RTC
17	001193-19NS	Red Button Index, Press-in
18	014200-45	Star Washer, Anti-Rotation

Product Specifications:
8" Wall Mount Mixing Faucet, Quarter-Turn Eterna Cartridges w/ Spring Checks, Lever Handles, 8" Swing Nozzle w/ Stream Regulator Outlet, Soap Dish and 1/2" NPT Female Inlets

Product Compliance:
ASME A112.18.1 / CSA B125.1
NSF 61 - Section 9
NSF 372 (Low Lead Content)
ANSI A117.1 (ADA)