

EZ-Fit[®] Lid L2400C



Lid Dispenser Instruction Guide

Thank you for purchasing the EZ-Fit Lid Dispenser from San Jamar. EZ-Fit Lid is designed to provide simple, sanitary lid dispensing that is easy and convenient for both you and your guests. If you have any questions or comments, please do not hesitate to contact us at www.sanjamar.com or (262)723-6133.

Note: EZ-Fit Lid Dispensers are intended for use with flat, cold beverage lids only. This product is not designed for use with domed lids or most contoured hot beverage lids. For best performance, test lid compatibility prior to installation.

The L2400C EZ-Fit Lid Dispenser is designed for use with lids larger than 3.75" in diameter. For smaller lids, please use the L2200C EZ-Fit Lid Dispenser.

IN-COUNTER MOUNTING INSTRUCTIONS

1. Cut hole in counter surface.

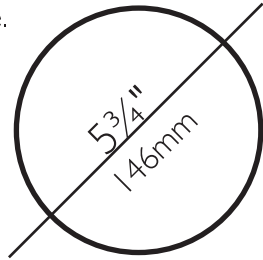

2. Remove trim ring with lid dispenser door assembly attached by turning counterclockwise.

3. Insert dispenser tube into counter and secure mount ring to counter with screws provided (#8 screws).

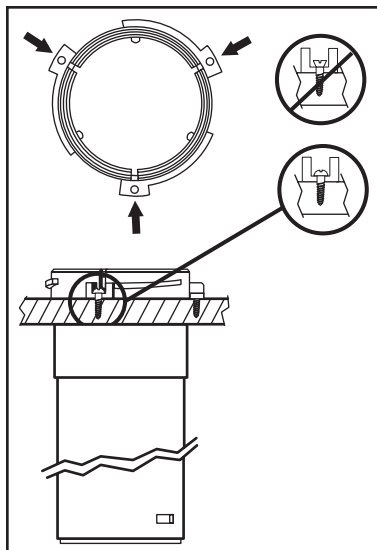

4. Replace trim ring with lid dispenser door assembly by turning clockwise.

5. Rotate lid dispenser door assembly (a) to desired orientation (b).

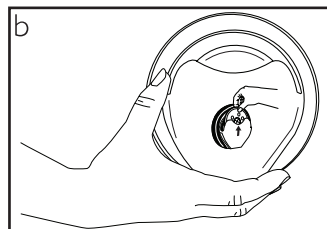
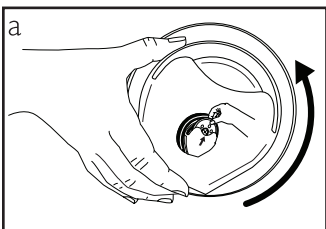

LOADING INSTRUCTIONS

1. Open lid dispenser door by pressing down on top of door assembly (a) and pulling outward (b), releasing door latch.

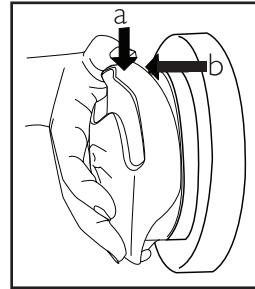

2. Load full sleeve of lids, assuring that inside of lids are facing outward, as shown.

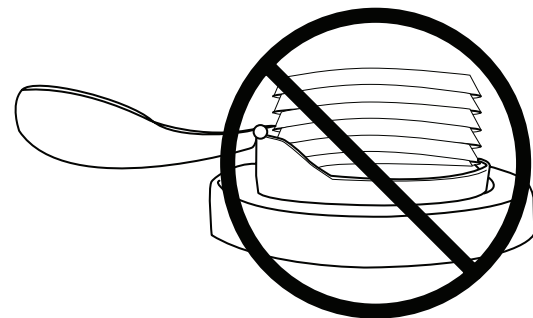
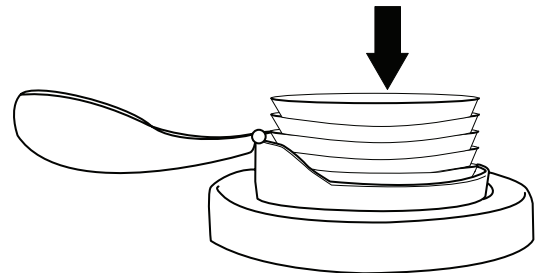

3. While holding lids in place, close lid dispenser door, snapping latch securely in place.

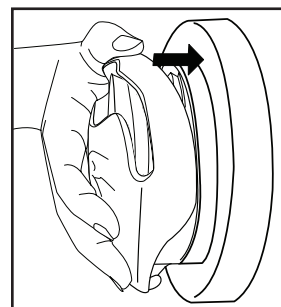

EZ-FIT® LID DISPENSER PRODUCT LINE

Item No.	Description	Lid Rim Dia.	Approx. Size
L2200C	Small Lid Dispenser	2.75" to 3.75"	8oz. to 24oz.
L2400C	Large Lid Dispenser	3.75" to 4.50"	24oz. to 64oz.

Tips for Best Dispensing Performance

1. Be sure lids are always loaded with the top side of lid loaded first, with inside of lids and lid flanges facing outward, as shown in loading instructions.
2. EZ-Fit Lid is designed for use with flat, cold beverage lids only. Dispenser may not dispense properly if using contoured hot beverage lids or domed lids.
3. Some brands and styles of beverage lids may dispense better than others, due to the tightly nested nature of the lid stack. For best results, test lid performance before use.

REPLACEMENT PARTS FOR L2400C

Lid Door Cover
Item #: 100667



Trim Ring
Item #: X24TR



Lid Holder
Item #: 100668



Mount Ring
Item #: X24MT

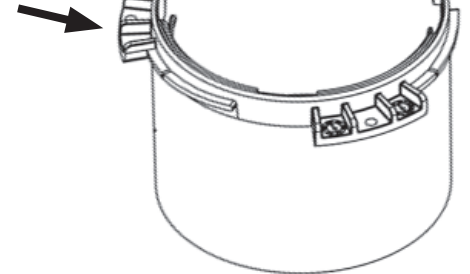

Push Plate
Item #: 100669



San Jamar
555 Koopman Lane
Elkhorn, Wisconsin 53121
USA
T: +1.262.723.6133
F: +1.262.723.4204
info@sanjamar.com
www.sanjamar.com

Canada
15252 32nd Avenue
Suite 309
Surrey, BC V3S 0R7
CANADA
T: +1.262.723.6133
F: +1.262.723.4204
canada@sanjamar.com

Europe
Schoorstraat 26a, bus 1
2220 Heist op-den Berg
BELGIUM
T: +32 15 22 81 40
F: +32 15 22 81 48
emea@sanjamar.com

México
Av. Paseo de la Reforma No. 350 - 10
Col. Juárez
Deleg. Cuauhtemoc, CP 06600
MEXICO, D.F.
T: +52 (55) 3626 0772
mexico@sanjamar.com

