

# SENTRY ONE-SIZE-FITS-ALL CUP DISPENSER INSTALLATION INSTRUCTIONS

This bag contains: Instruction Sheet, Contamination Guard and a Spring to be used with Foam Cups.

1. Cut hole in counter surface.

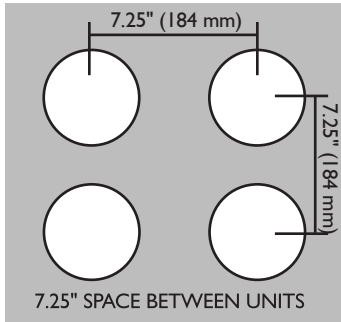

2. Remove cover ring turning counterclockwise.

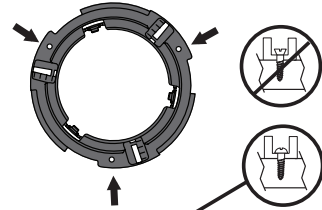

3. Secure mounting ring to counter with #8 screws.

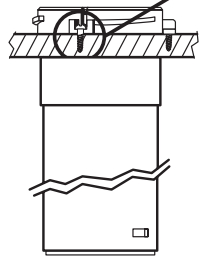

4. Load cups.

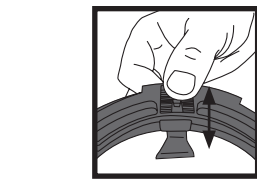

5. Move the adjustment levers to assure one-at-a-time dispensing.

6. Install Contamination Guard over posts in underside of ring.

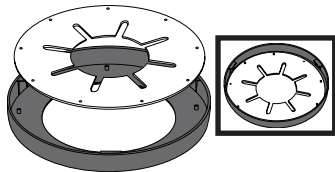

7. Replace cover ring with gasket by turning clockwise over mounting ring until secure.

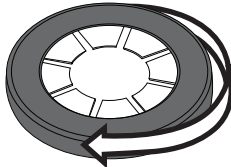

8. **TO REFILL DISPENSER:**  
Load cups through contamination guard.

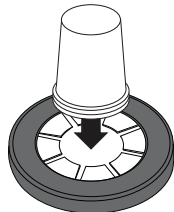

## SPRING REPLACEMENT INSTRUCTIONS

1. Determine the type of spring that you need. The spring for paper/plastic cups has a higher spring force than that for foam:

Paper/Plastic Spring = 18 coils (factory installed)

Foam Spring = 13.5 coils

## IDENTIFYING SPRING TYPE

Look at spring from the top down.

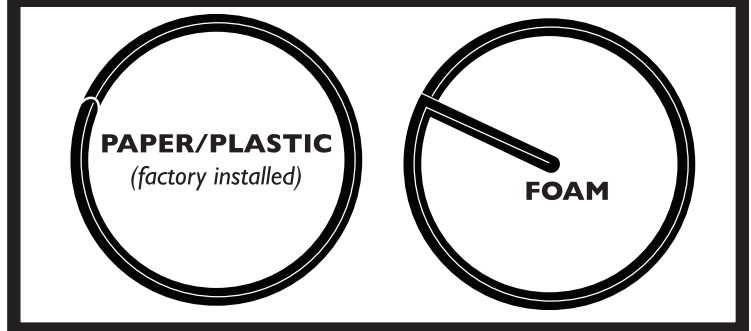

2. Turn the dispenser upside down so the dispenser opening faces down.
3. Remove the end cap by twisting it counter-clockwise and lifting (a).
4. Replace the existing spring with the desired spring.
5. Replace the end cap by lining up the slots with the tabs on the cap, push down, and turn clockwise (b).

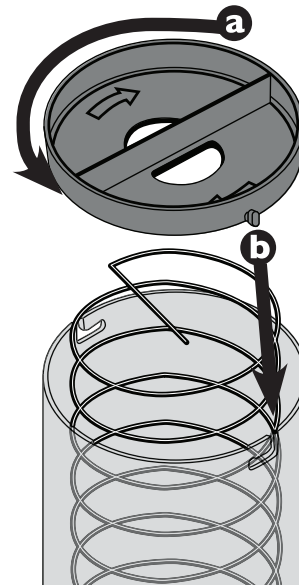

**San Jamar**  
555 Koopman Lane  
Elkhorn, Wisconsin 53121  
USA  
T: +1.262.723.6133  
F: +1.262.723.4204  
info@sanjamar.com  
www.sanjamar.com

**Canada**  
15252 32nd Avenue  
Suite 309  
Surrey, BC V3S 0R7  
CANADA  
T: +1.262.723.6133  
F: +1.262.723.4204  
canada@sanjamar.com

**Europe**  
Schoorstraat 26a, bus 1  
2220 Heist op-den Berg  
BELGIUM  
T: +32 15 22 81 40  
F: +32 15 22 81 48  
emea@sanjamar.com

**México**  
Av. Paseo de la Reforma No. 350 - 10  
Col. Juárez  
Deleg. Cuauhtemoc, CP 06600  
MEXICO, D.F.  
T: +52 (55) 3626 0772  
mexico@sanjamar.com

**san jamar**  
smart. safe. sanitary.

# INSTRUCCIONES PARA LA INSTALACION DE EL DISPENSADOR DE VASOS AJUSTABLE

Esta bolsa contiene: Manual de Instrucciones, Protección contra Contaminación y el resorte para ser instalado si usted va a usar vasos de unigel.

## 1. Perfore el orificio en el mostrador.

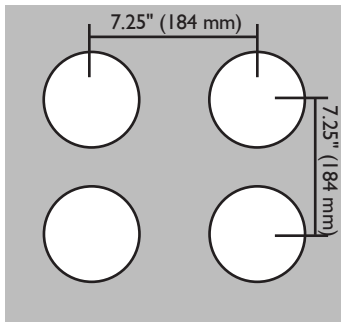
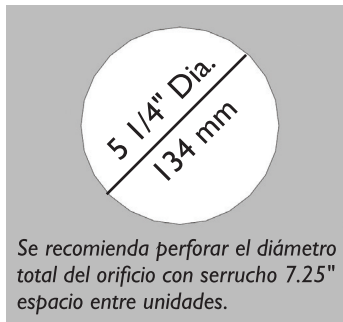

## 2. Remueva el anillo de cobertura girando en el sentido de las manecillas del reloj.

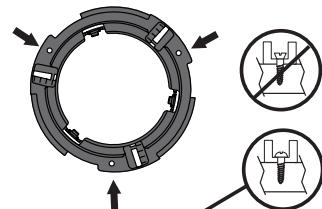

## 3. Fije el anillo para montar en el mostrador, utilizando tornillos # 8 .

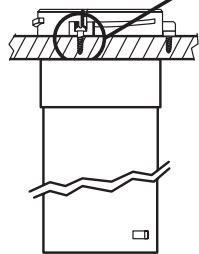

## 4. Inserte los vasos.

## 5. Ajuste la palanca para asegurar que se despachen los vasos uno a la vez.

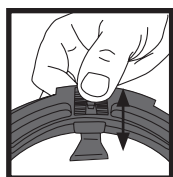

## 6. Instale la protección contra contaminación sobre el poste y bajo el anillo.

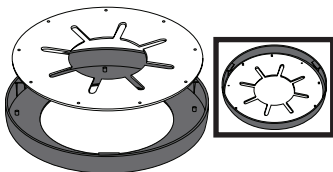

## 7. Reemplace el anillo de cobertura con el gasquete girando en sentido de las manecillas del reloj.

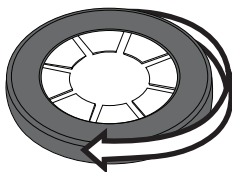

## 8. PARA CARGAR EL DISPENSADOR:

Inserte los vasos a través de la protección contra contaminación.

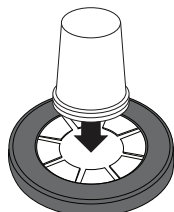

## INSTRUCCIONES PARA REMPLAZAR EL RESORTE

- Determine que tipo de resorte necesita. El resorte para vasos de papel/plástico tiene mayor fuerza que el que se utiliza para vasos de unigel (foam):  
Resorte para papel/plástico = 18 coils (instalado en fabrica)  
Resorte para unigel (foam) = 13.5 coils

### COMO IDENTIFICAR EL TIPO DE RESORTE

Mire el resorte de arriba hacia abajo.

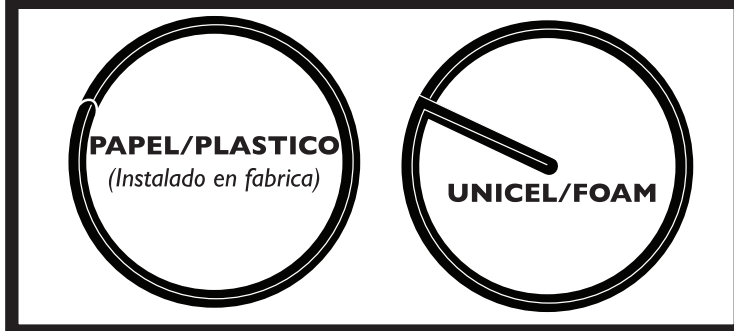

- Coloque el dispensador con la tapa hacia abajo.
- Remueva la cubierta girándola en sentido de las manecillas y levantándola (a).
- Cambie el resorte existente por el resorte deseado.
- Reemplace la cubierta alineando las ranuras con las lengüetas de la tapa, empuje hacia abajo, y después gire en sentido de las manecillas del reloj (b).

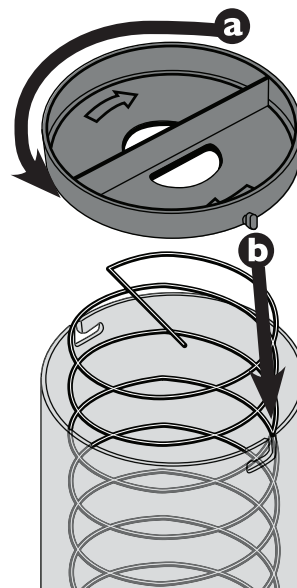

**San Jamar**  
555 Koopman Lane  
Elkhorn, Wisconsin 53121  
USA  
T: +1.262.723.6133  
F: +1.262.723.4204  
info@sanjamar.com  
www.sanjamar.com

**Canada**  
15252 32nd Avenue  
Suite 309  
Surrey, BC V3S 0R7  
CANADA  
T: +1.262.723.6133  
F: +1.262.723.4204  
canada@sanjamar.com

**Europe**  
Schoorstraat 26a, bus 1  
2220 Heist op-den Berg  
BELGIUM  
T: +32 15 22 81 40  
F: +32 15 22 81 48  
emea@sanjamar.com

**México**  
Av. Paseo de la Reforma No. 350 - 10  
Col. Juárez  
Deleg. Cuauhtemoc, CP 06600  
MEXICO, D.F.  
T: +52 (55) 3626 0772  
mexico@sanjamar.com

**san jamar**  
smart. safe. sanitary.