



# INSTALLATION AND OPERATION MANUAL

## GARLAND INDUCTION TEMPERATURE CONTROLLED TABLETOP HOLD-LINE

with RTCSmp TECHNOLOGY  
Real-time Temperature Control System  
multi-point sensing



**CE models** comply with the latest European Norms:  
EN 60335-1, EN 60335-2-36, EN 62233 (EMC/EMV)

**North American models:** ETL listed in compliance with UL 197, CSA C22.2 No.109, NSF-4  
Complies with FCC part 18, ICES-001

### WARNING

**IMPROPER INSTALLATION, ADJUSTMENT, ALTERATION, SERVICE OR MAINTENANCE CAN CAUSE PROPERTY DAMAGE, INJURY, OR DEATH. READ THE INSTALLATION, OPERATING AND MAINTENANCE INSTRUCTIONS THOROUGHLY BEFORE INSTALLING OR SERVICING THIS EQUIPMENT**

Users are cautioned that maintenance and repairs must be performed by a Garland authorized service agent using only genuine Garland replacement parts. Garland will have no obligation with respect to any product that has been improperly installed, adjusted, operated or not maintained in accordance with national and local codes and/or installation instructions provided with the product or any product that has its serial number defaced, obliterated or removed, and/or which has been modified or repaired using unauthorized parts or by unauthorized service agents. For a list of authorized service agents and/or genuine replacement parts, please visit our website at [www.garland-group.com](http://www.garland-group.com) for USA and Canada. For international customers, please visit [www.manitowocfoodservice.com](http://www.manitowocfoodservice.com). The information contained herein, including design and part specifications, may be superseded and is subject to change without notice.



Model: HO1500



PLEASE READ ALL SECTIONS OF THIS MANUAL AND RETAIN FOR FUTURE REFERENCE.

THIS PRODUCT HAS BEEN CERTIFIED AS COMMERCIAL COOKING EQUIPMENT AND MUST BE INSTALLED BY PROFESSIONAL PERSONNEL AS SPECIFIED

INSTALLATION AND ELECTRICAL CONNECTION MUST COMPLY WITH CURRENT CODES:  
IN CANADA – THE CANADIAN ELECTRICAL CODE PART 1 AND / OR LOCAL CODES.  
IN USA – THE NATIONAL ELECTRICAL CODE ANSI / NFPA – CURRENT EDITION.

### FOR YOUR SAFETY

**DO NOT STORE OR USE GASOLINE OR OTHER FLAMMABLE VAPORS OR LIQUIDS IN THE VICINITY OF THIS OR ANY OTHER APPLIANCE**



Visit our **Video Gallery** at [www.Garland-Group.com](http://www.Garland-Group.com)



## WARRANTY





Our warranty statements for induction products are available on-line. Please visit our website at [www.garland-group.com/minisite/service](http://www.garland-group.com/minisite/service) to download the latest revision. If you might have any questions, please contact Garland.

## USING THIS MANUAL

This manual contains important information regarding safety, installation, operation, maintenance, and troubleshooting. They must be read entirely and carefully by the installers and operators before the equipment is installed and taken into operation. This manual must always be available for reference at the place of operation.

Throughout this manual, the induction unit type "RTCSmp Heat Retaining Hold-Line" is referred to as "induction unit".

## DESCRIPTION OF WARNING SYMBOLS

	This symbol alerts you to a hazardous situation that WILL or COULD cause serious bodily harm or death. Be alert and implement relevant safety precautions.
	This dangerous voltage warning symbol indicates a risk of electric shock and hazards from dangerous voltage.
CAUTION	This symbol alerts a hazardous situation, which if not avoided, COULD cause minor to moderate personal injury or property damage. The relevant safety precautions MUST be implemented at all times.
	Electromagnetic field.
	<div style="border: 1px solid black; padding: 5px; text-align: center;"> <p><b>Warning</b>  <b>Risk of fire or electric shock</b>  <b>Do not open</b></p> </div> <div style="text-align: center;">  </div> <p>To reduce the risk of fire or electric shock, do not remove or open cover.              No user serviceable parts inside.              Refer servicing to qualified personnel.</p>

## CONTACTS

Garland Commercial Ranges Ltd.  
 1177 Kamato Road, Mississauga, Ontario, Canada. L4W 1X4  
 T: 1-905-624-0260 | F: 1-905-624-5669 | [www.garland-group.com](http://www.garland-group.com)

USA Sales, Parts and Service    1-800-424-2411  
 Canadian Sales                    1-888-442-7526  
 Canada or USA Parts/Service    1-800-427-6668  
 International Sales and Service [www.ManitowocFoodservice.com](http://www.ManitowocFoodservice.com)

# CONTENTS

<b>WARRANTY</b> .....	<b>2</b>
<b>USING THIS MANUAL</b> .....	<b>2</b>
<b>DESCRIPTION OF WARNING SYMBOLS</b> .....	<b>2</b>
<b>CONTACTS</b> .....	<b>2</b>
<b>1 Safety Requirements</b> .....	<b>4</b>
1.1 Risk Involved By Disregarding Safety Information .....	4
1.2 Safety Instructions for Operator .....	4
1.3 Improper Use of the Equipment .....	5
1.4 Unauthorized Modification and Use of Spare Parts .....	5
1.5 Pan Detection .....	6
1.6 Cooking Zone Monitoring .....	6
<b>2 Components and Features</b> .....	<b>7</b>
2.1 Application .....	7
2.2 Components Included .....	7
2.3 Features .....	7
<b>3 Dimensions and Technical Specifications</b> .....	<b>8</b>
3.1 Rating Plate .....	8
3.2 Nomenclature and Model .....	8
3.3 Electrical Specifications .....	8
3.4 Dimensions .....	8
3.5 Operating Conditions .....	9
3.6 Compliances .....	9
<b>4 Installation</b> .....	<b>10</b>
4.1 Location .....	10
4.2 Ventilation .....	10
4.3 Adjustable Feet .....	11
4.4 Electrical Installation .....	11
<b>5 Function Test</b> .....	<b>13</b>
<b>6 Operating Instructions</b> .....	<b>15</b>
6.1 Proper Induction Serving Pans .....	15
6.2 Proper Placement of Cookware .....	16
6.3 Temperature Control and Display .....	16
6.4 No Pan No Heat .....	17
6.5 When Unit is Not In Use .....	17
<b>7 Cleaning</b> .....	<b>18</b>
<b>8 Maintenance</b> .....	<b>19</b>
<b>9 Important Rules</b> .....	<b>19</b>
<b>10 Troubleshooting</b> .....	<b>20</b>
10.1 Common causes for induction unit failure .....	20
10.2 Problems and Possible Causes .....	21
10.3 Troubleshooting with Error Codes (for Service Technicians) .....	22

# 1 Safety Requirements

**WARNING**

This product contains chemicals known to the State of California to cause cancer. Installation and servicing of this product could expose you to airborne particles of glass wool / ceramic fibers. Inhalation of airborne particles of glass wool / ceramic fibers is known to the State of California to cause cancer.

**IMPORTANT**

Warning labels mounted directly on the induction unit must be observed at all times and kept in a fully legible condition.

**IMPORTANT**

To ensure your working environment is safe, you must follow all of the safety instructions contained in this manual, the existing national regulations for accident prevention with electrical systems, as well as any relevant company-specific safety instructions.



The induction unit should only be used if and only if the installation of the electrical system is fitted by an approved installation contractor in accordance with specific national and local regulations.

## 1.1 Risk Involved By Disregarding Safety Information

Disregarding the safety instructions may cause harm to people, the surroundings, and the induction unit. Garland is not responsible for any damages or personal injury caused by failure to observe the safety requirements. Risks involved when disregarding safety precautions may include:

- Death or injury caused by electric shock.
- Injury due to burns from contacting overheated cooking surface, cookware, or oil and grease.
- Damage to the induction unit caused by using unsuitable cookware.

## 1.2 Safety Instructions for Operator

Please follow the following rules to avoid personal injuries and property damages:

- When the unit is in use, heat transfers from the cookware to the glass-top; the glass-top can become hot. To avoid burn injuries, do not touch the heating area when the unit is in use.
- The induction unit heats up cookware quickly. Do not leave an empty pan on the unit and do not leave the unit unattended during operation.
- If the glass-top is cracked or broken, switch off the induction unit immediately and if possible and safe, disconnect it from the power supply. Do not touch any parts inside the induction unit.
- Do not put any other items on the glass cook-top except non-empty induction cookware.
  - Do not leave any object such as paper, cardboard, or cloth between the cookware and the cooking surface, as this might start a fire.
  - Metallic objects are heated up very quickly when placed on the induction unit when it is in use. Do not place any objects such as closed cans, aluminum foil, cutlery, jewelry, or watches on the induction unit.

- Do not place credit cards, phone cards, tapes, or any objects sensitive to magnetism on the cooking surface.
- Do not place plastic vessels and aluminum objects such as aluminum foil on the glass-top.
- Persons with a cardiac pacemaker should consult their doctor whether they are safe near an induction unit.
- If the power cord is damaged, have it replaced immediately by an approved service technician.
- Ensure liquid cannot enter into the induction unit. Do not let water or food overflow the cooking area. Do not use hoses to clean or power wash the induction unit or its vicinity.
- The induction unit has an internal air-cooling system. Do not block the air intake and exhaust openings with objects such as cleaning cloths or containers. Any obstruction to the air intake and exhaust could cause the unit to overheat and to switch off.
- Switch the unit OFF if you take the cookware away for a while. This will prevent the heating process to start automatically and unintentionally when a pan is placed back on the heating area. If any person needs to use the induction unit, he/she will have to turn the unit ON intentionally.
- A dirty air filter blocks the fresh air inlet. The Air Inlet Filter should be cleaned at least once a week (dishwasher safe) or as often as necessary. Wipe the filter dry before putting it back into the unit.
- Remove immediately any food residuals from the glass-top.
- Use only induction suitable cookware with proper size and made of proper material. The induction suitable cookware should also be in good condition without any uneven, arched or partially detached bottoms.
- Protect the induction unit from steam if the unit is placed next to high steam emitting equipment such as pasta cookers, steamers, and water bath.
- Do not place the induction unit next to a heat producing unit such as an oven or a deep fryer.

### 1.3 Improper Use of the Equipment

The reliability of the induction unit can only be guaranteed when it is used properly. The induction unit must always be operated within the limits provided in the technical specifications. Please refer to section **9 Important Rules** of using induction equipment.

### 1.4 Unauthorized Modification and Use of Spare Parts

Please contact the manufacturer if you intend to make any changes on the induction unit. For safety reasons, always use genuine parts and accessories approved by Garland. Any unauthorized modification as well as any installation of unapproved components will void all warranty.

## 1.5 Pan Detection

Energy is transferred to cookware when the induction system detects a suitable pan on the heating area. The digital display signals to communicate the Pan Detection process.

- When the unit is ON without any pan on the hob, the display shows the current temperature without a dot; the unit is in pan detection mode.
- As soon as a pan is put on the hob, the heating process is engaged and the display shows the current temperature with a dot flashing.
- However, if the unit is not detecting any pan, the current temperature is shown without a dot.

**NOTE:** Pan with a bottom diameter smaller than 5" (12 cm) is not detected by the system.

## 1.6 Cooking Zone Monitoring

Each cooking zone is monitored by multiple temperature sensors beneath the glass cook-top. The sensors can detect overheated empty pans or overheated oil and grease. When this occurs, the system stops the energy supply to the pan. You must turn the unit off and let it cool down before restarting it.

**CAUTION**

To avoid burn injuries, do not touch the unit when a pan is overheated and take all the necessary precautions when removing the overheated pan.

## 2 Components and Features

### 2.1 Application

The RTCSmp Tabletop Hold-Line units are ideal for buffets, events and banqueting, providing constant and precise temperature to ensure top quality food presentations and appeal. Temperature adjustment within a large temperature range (122-212°F / 50-100°C) allows for flexibility and precise food temperature requirements. To guarantee the induction units' reliability and performance, please observe all safety, installation, and operation requirements mentioned in this manual.

### 2.2 Components Included

- 1 RTCSmp Induction Tabletop Heat Retaining Unit with Cord and Plug.
- Installation and Operation Manual.

### 2.3 Features

Built with a robust construction, the RTCSmp Hold-Line units are compact and powerful with a revolutionary RTCSmp-Technology (Realtime Temperature Control System with Multi-Point sensing). The RTCSmp Technology monitors the energy supply, the state of the induction coil, power board, CPU, and the cooking zone in realtime. Please review the following features this induction unit offers:

- Engineered specifically for warm holding applications.
- Compact, light weight and low profile design with controls on the bottom of the unit.
- Integrated cooling fan keeps electronics cool.
- Air deflector prevents hot exhaust air to be pulled back into the unit.
- Removable and dishwasher-safe air intake filter.
- Two heat zones.
- High impact Ceran® glass-top with two highly visible digital displays beneath to show the set and the current temperatures.
- Thermostatically controlled overheat sensor shuts off the unit preventing damage from pans cooking dry.
- Instant energy transmission to the cookware only, not to the surrounding air.
- Electronic output limitation continually monitors the energy transfer to the cookware, ensuring the most efficient energy transfer possible.
- The control unit regulates the temperature in an increment of 5°F(1°C), from 122-212°F / 50-100°C.
- Simple to operate. Adjust power level simply by turning the knob.

### 3 Dimensions and Technical Specifications

#### 3.1 Rating Plate

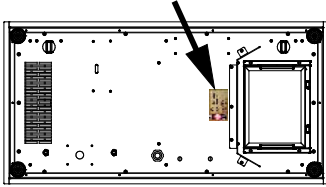

The rating plate specifies important information such as model number, serial number, and electrical specifications. The rating plate is affixed to the bottom of the unit, next to the air intake and air deflector.

#### 3.2 Nomenclature and Model

Series	Power (Watt)	Voltage (Volt)	Model
HO = Hold Line	1500	120	HO1500-120

#### 3.3 Electrical Specifications

Model	Voltage	Power	No. of Heat Retaining Zones
HO1500	120 V AC / 1Ph	1500 W (2x 750W) / 12A	2

#### 3.4 Dimensions

Model	Glass Top Only (width x depth x height)	Overall Dimensions (width x depth x height)	Weight
HO1500	31.50" x 15.75" x 0.169" (800 x 400 x 4 mm)	31.50" x 15.75" x 4.49" (800 x 400 x 114 mm)	17kg/ 37.5lb

Dimensions: RTCSmp Tabletop Hold-Line HO1500

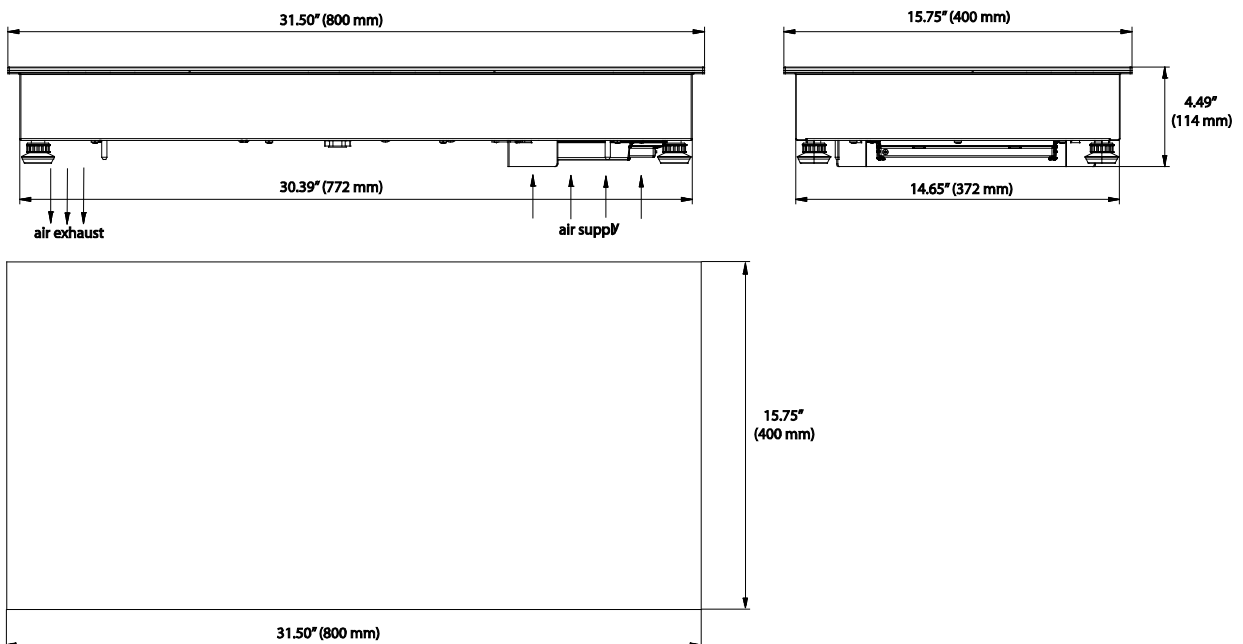



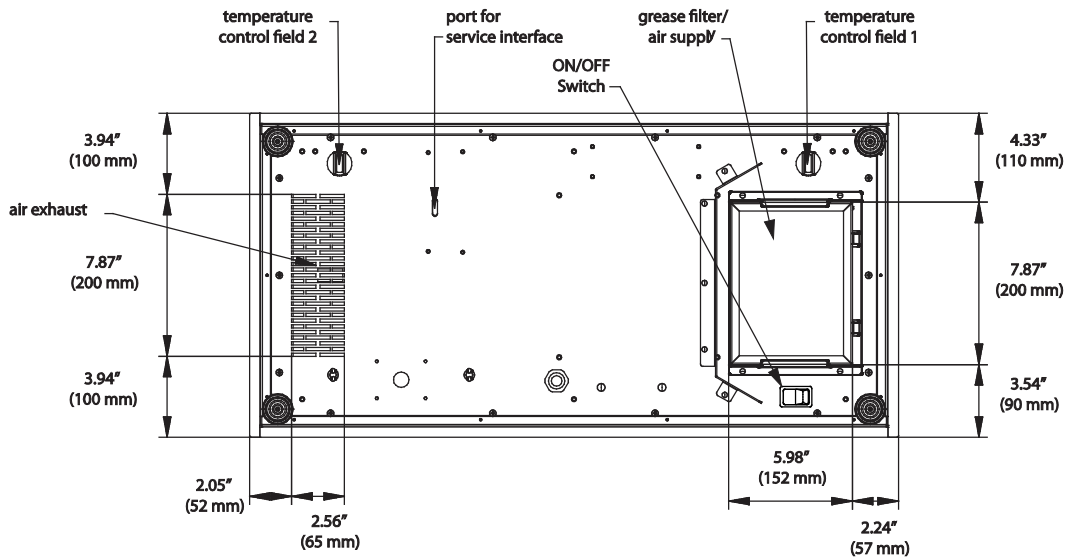

### 3.5 Operating Conditions

Max. Tolerance of Nominal Supply Voltage	+6 /-10 %
Supply frequency	50/60 Hz
Ingress Protection class	IP X3
Minimal Diameter of Cooking Pan	5" (12cm)
Maximum Ambient Temperature	In Storage > -4°F to +158°F (-20°C to +70°C) In Operation >+ 41°F to +104°F (+5°C to +40°C)
Maximum Relative Air Humidity	In Storage > 10% to 90% In Operation > 30% to 90%
Set Temperature Range	122-212°F / 50-100°C
Clearance from Materials	Min. 1.18" / 30mm

### 3.6 Compliances

- **North American models:**  
ETL listed in compliance with UL 197, CSA C22.2 No.109, NSF-4. Complies with FCC part 18, ICES-001
- **CE models** comply with the latest European Norms:  
EN 60335-1, EN 60335-2-36, EN 62233 (EMC/EMV)

## 4 Installation

### IMPORTANT

- Kitchen designers and installation contractors are responsible for designing and installing correctly the appropriate support structures and ventilation system for the cooking equipment.
- The installation, including electrical installation, must be carried out by registered installation contractors only. The contractors are responsible for interpreting all instructions correctly and performing the installation in compliance with national and local regulations. The warning signs and rating plates on the cooking equipment must strictly be followed.
- Read ALL SECTIONS carefully, comply with all requirements listed and ensure all inspection is done by qualified personnel.
- Refer to the technical data given in chapter **3 Dimensions and Technical Specifications**.
- **Induction equipment that is not installed correctly will have warranty voided. See Warranty, p.2.**

### 4.1 Location

- The RTCSmp counter top unit must be installed securely on a flat, leveled and even surface. The induction unit must be set up in a way that it cannot fall down or move to an uneven position.
- Level and height adjust the unit by adjusting the feet. If necessary, secure the unit in place with the Tabletop Self-adhesive Bottom Pads (part# 72264020). See **4.3 Adjustable Feet**.
- Do not place the induction unit on or near a hot surface or any heat producing equipment such as an oven or a deep fryer.
- Protect the induction unit from steam if the unit is placed next to high steam emitting equipment such as pasta cookers, steamers, and water bath.
- Allow easy access to the temperature control knobs and the ON/OFF switch on the bottom of the unit.
- Keep the induction unit away from combustible materials, vapors or liquids.

### 4.2 Ventilation

Proper cool air intake and ventilation is essential to the reliability and functioning of the induction unit. Please ensure all requirements listed below are met:

- This induction unit is equipped with an internal air cooling system. Ensure the air supply and air exhaust outlets are not blocked. **Clearance:** minimum 1.18" (30mm).
- Ensure the induction unit does not take in hot ambient air from other surrounding units and appliances, especially when the installed location of the unit is close to a heat generating equipment such as a fryer or an oven.
- The air intake temperature must not exceed 104°F (40°C).

## 4.3 Adjustable Feet

- The feet (provided) on the countertop unit are height-adjustable and lockable. (Feet Complete Assembly part# 95000120)
- There are non-slip rubber pads on the feet.
- Optional: the feet can be inserted into the Tabletop Self-Adhesive Foot Pads (part# 72264020). These pads can be affixed onto the counter surface.

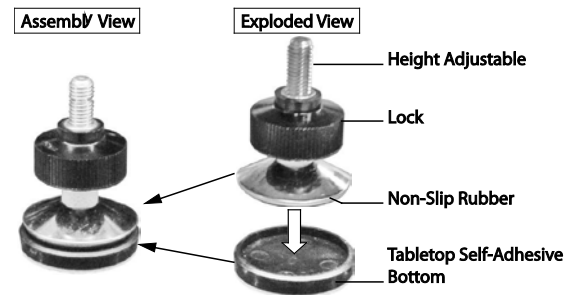

- To adjust the height of the unit, simply rotate the feet to raise or lower the unit.
- To lock the feet into position, rotate the plastic locks counter-clockwise and tighten them against the bottom of the unit.

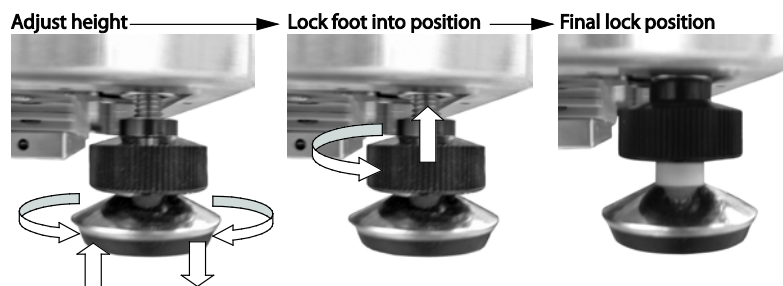

## 4.4 Electrical Installation

### IMPORTANT

- Refer to the specifications in chapter **3 Dimensions and Technical Specifications** **AND** the rating **plate/instruction labels on the unit**. Always refer to the rating plate/instruction labels on the unit to verify the electrical data. Rating plate/label information overrides the information listed in this manual.
- Check and ensure that the supply voltage and the line current match the specifications given on the rating plate. A stable mains supply must be provided.

### CAUTION

Wrong voltage will damage the induction unit. Follow strictly the specifications on the rating plate.

- The electrical connections must satisfy the national and local electrical codes.
- If ground fault current protective switches are used, they must be provided with selective activation and designed for a minimum fault current of 30mA. Multiple generators with a mains connection must not be connected to a single fault current protective switch.
- This induction unit is equipped with a power cable which can be connected with the necessary plug to the socket. Ensure the plug is easily accessible for disconnecting from the power supply. Put the control knob in the 0 (OFF) position **BEFORE** connecting to the electrical supply.

**To setup the unit for operation:**

1. The ON/OFF switch is on the bottom of the unit, next to the air filter.

Ensure the ON/OFF switch is at the OFF-position.

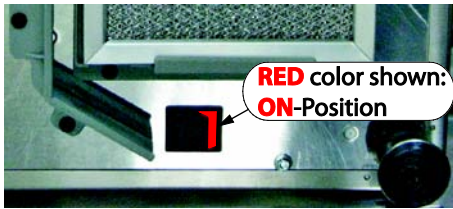

2. Remove all objects from the glass top and check that the glass-top is neither cracked nor broken.

**CAUTION**

Do not continue if the glass-top is cracked or broken.  
Contact an authorized service agency for assistance.

3. Connect the unit to the power supply.
4. Perform the Function Test. See chapter **5 Function Test**.

## 5 Function Test

### IMPORTANT

#### CAUTION

When the unit is in use, the cookware will warm up the glass-top. To avoid burn injuries, do not touch the glass-top.

- Remove all objects from the glass-top and verify that the glass-top is not cracked or broken.

#### CAUTION

Do not continue if the glass-top is cracked or broken. Immediately switch off the unit and if possible and safe, disconnect it from the power outlet. Contact a Factory Authorized Service agency.

- Before carrying out the function test, the user must understand how to operate the unit.
- Always use a pan or a chafing dish suitable for induction cooking, having a bottom diameter of at least 5"(12cm).
- See **6.1 Proper Induction Serving Pan** and **6.2 Proper Placement of Serving Pan**.
- NEVER LEAVE AN EMPTY PAN ON AN INDUCTION HOB.**

### To perform a function test:

- Turn the unit ON using the ON/OFF switch on the bottom of the unit.

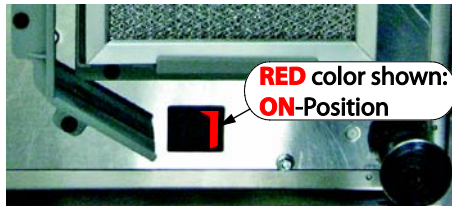

- The RTCSmp HO 1500 unit has two heating zones. Put some water in the induction pan and place it in the center of a heating zone.
- Turn the control knob to select a temperature between 122-212°F (50-100°C). The digital display

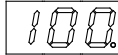
underneath the Ceran® glass shows the selected temperature followed by a dot .

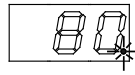
Within 2 seconds, the display shows the actual temperature followed by a blinking dot . This means energy is being transferred to the pan and the water is heated.

**NOTE** If you are using both heating zones at the same time, note that power is cycled from one zone to another. This means when the left zone is active and the dot blinks, the right zone is dormant and its temperature is shown without a dot, and vice versa. This is normal.

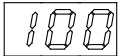
- Take the pan away from the heating zone and power transmission stops. The displays shows the current temperature without a dot, for example .
- Place the pan back on the heating area and the heating process starts again; the dot blinks.
- Turn the control knob to the lowest position. If the temperature is over 122°F (50°C), the display shows "hot". Otherwise, the display is off.
- Use the ON/OFF switch to turn the power off.

When the knob is in an ON-Position and the display remains off, check:

- Is the induction unit connected to the power supply?
- Is the control knob in an ON-Position?

If the point blinks but the pan is not heated up, or the display shows the temperature without a blinking point:

- Are you using a suitable pan or dish? See section **6.1 Proper Induction Serving Pan**.
- Is the pan placed in the center of the heating area? See section **6.2 Proper Placement of Serving Pan**.

For further assistance, see chapter **10 Troubleshooting** or call a Factory Authorized Service agency.

## 6 Operating Instructions

### IMPORTANT

- Induction units are more powerful, heat up pans quicker, and cook food faster than conventional cooking equipment. Your induction unit will require different use and care than other conventional equipment. Do not operate the induction equipment without reading this manual and follow all safety requirements. Refer to chapter **1 Safety Requirements**.
- This appliance is for professional use and shall be used only by qualified personnel.

### CAUTION

Do not put any empty cookware on the hob when the induction unit is ON. The induction unit heats up empty pans very quickly. Overheated empty pan can cause personal injury and damages to cookware and the induction unit. To avoid overheating, always put food products or oil into the pan before turning the induction unit on.

- Induction unit offers short cooking time. When you turn the power level up, the temperature of the pan and its contents is changed quickly. Therefore especially when you heat up oil or grease, check the cooking process frequently to prevent the oil or grease from overheating and burning.
- **BROIL-DRY PROTECTION**  
The RTCSmp electronic temperature control monitors overheating at the pan base. When an overheated pan (overheated oil, empty pan) is detected, energy transfer from the generator to the pan will be stopped immediately. You must turn the unit off, let it cool down before re-starting the unit.

### 6.1 Proper Induction Serving Pans

**IMPORTANT** Using unsuitable cookware on the induction unit can cause the unit to fail prematurely, void your warranty, or incur high service costs.

- The RTCSmp HO 1500 has two heat zones and ten sensors beneath the glass top. It is engineered to use with a large variety of induction standard pans, Gastronorm serving pans, and chafing dishes. Garland has carefully selected a range of special induction serving pans for purchase. Please contact your dealer for details.

#### **IMPORTANT: CONDITION OF COOKWARE**

Pans with layer separation (outward and inward bubbles), arching or partially detached bottoms **must be replaced**. When these pans are used, the sensors under the glass-top cannot detect temperature correctly. **These pans will overheat the sensors below and eventually will damage them.** Illustration below shows examples of good and bad pans in cross-sections.

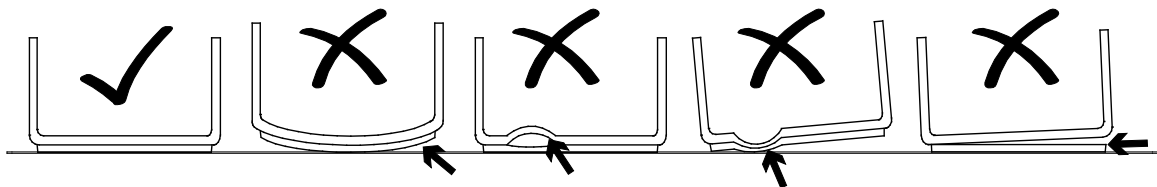

#### **Material**

Use cookware made of conductive and magnetic materials. If the pan bottom attracts a magnet, the pan is suitable for induction cooking. Look for cookware that is labeled "suitable for induction" or is marked with an induction compatible symbol.



Induction

- **Size**

**Minimum size:** The bottom of the chafing dish or pan must have a diameter of at least 5" (12cm). Otherwise, the sensors will not sense the pan properly.

**Do not use oversized pans** on the induction unit. The bottom of the pan must fit the glass. A hot, oversized pan may damage the electronic components inside the induction unit.

## 6.2 Proper Placement of Cookware

The RTCSmp Hole-Line 1500 model has two heat-zones. Each heat-zone is equipped with the latest RTCSmp sensor technology which enables temperature controls in realtime. There are ten sensors underneath the glass-top; five sensors for each heat-zone. To obtain optimal results from the sensors, always place the pan in the center of the heat-zone.

## 6.3 Temperature Control and Display

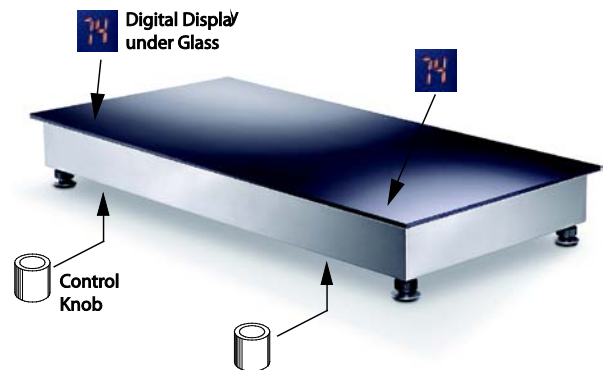
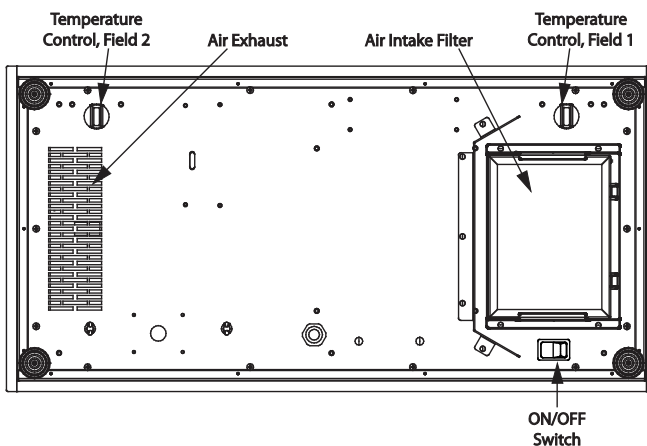

- **Turn the power on with the ON/OFF switch.**
- The RTCSmp Tabletop HO 1500 unit has two heating zones, which can be controlled separately. The desired temperature can be set by turning the control knob and the unit is **immediately ready** for operation.
- You can adjust the temperature in an increment of 5°F (1°C), from 122-212°F (50-100°C).

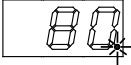
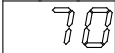

**Digital Display:**

-  Temperature followed by a dot: When you turn the control knob, the digital display shows the selected temperature followed by a dot. Within 2 seconds, the display will show the actual temperature.
-  Temperature followed by a blinking dot: The blinking dot indicates the induction zone is active and the current temperature is displayed. This means the system has detected a pan in the heating zone and energy is being transferred to the pan.
-  Temperature without a dot: The display shows the actual temperature and the induction coil is dormant. This means no energy is being transferred.
- To shutdown the unit, simply turn the ON/OFF switch to the OFF-position.

**NOTE** If you are using both heating zones at the same time, note that power is cycled from one zone to another. This means when the left zone is active and the dot blinks, the right zone is dormant and its temperature is shown without a dot, and vice versa. This is normal.

## 6.4 No Pan No Heat

When a temperature is selected, the induction unit only transmits energy when a pan is placed in the heating zone. If you remove the pan from the heating zone, power transfer to the pan stops immediately. If the pan is put back in the heating zone, power is transferred to the pan again.

Note that pan with a bottom diameter smaller than 5"(12 cm) is not detected by the system.

After switching the unit off, there is no heat retained inside the unit.

## 6.5 When Unit is Not In Use

**Best Practice:** If the induction unit is not in use, ensure the ON/OFF switch is in the 0 (OFF) position.

- Switch the unit OFF if you take the cookware away for a while. This will prevent the heating process to start automatically and unintentionally when a pan is placed back on the heating area. If any person needs to use the induction unit, he/she will have to turn the unit ON intentionally.

## 7 Cleaning

The cleaning of the Ceran® glass is identical to cleaning other similar glass surfaces. You may use any regular Ceran® glass cleaning products available from a grocery or hardware store.

### CAUTION

Ensure no liquid can get into the induction unit.  
Do not use hoses to clean or power wash the induction unit or its vicinity.



### IMPORTANT

- **DO NOT USE:** corrosive or abrasive cleaning agents, such as grill sprays, oven sprays, stain removers, rust removers, scouring powder, and rough sponges.
- Let the Ceran glass cook-top cool down before cleaning.
- Ensure to remove all residues of cleaning agents from the glass cook-top. Use a clean moist cloth to wipe off any such residues.

### IMPORTANT Air Intake Filter

**A dirty, blocked air intake filter can cause electronic damage to the induction unit.** The Air Intake Filter is inserted into the holder on the bottom of the unit. Check and clean the filter at least once a week or as often as required. The Air Intake Filter is dishwasher-safe. **Ensure the filter is DRY before putting it back into the unit.**

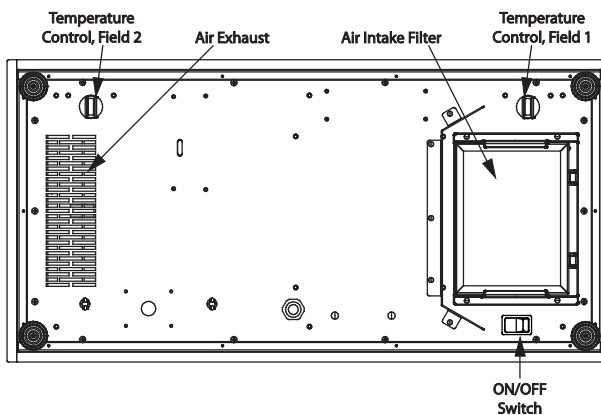

### Glass Cleaning

1. Use razor blade scrapers or non-scratching sponges to remove all residues on the glass.

When scraping, ensure you angle your razor blade scraper at about 20° to 30° from the glass.

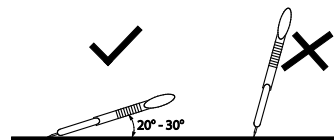

2. Wipe the glass clean with a damp cloth.

## 8 Maintenance

**CAUTION**

Maintenance and servicing work other than cleaning as described in this manual must be done by an authorized service personnel.

**Do not open the induction unit – dangerous electric voltage inside!**

The induction unit may only be opened by an authorized service personnel.

A good maintenance of the induction unit requires regular cleaning, care and servicing. The operator has to ensure all components relevant for safety are in perfect working order at all times.

**Best Practice:** The induction unit is to be examined once a year by an authorized technician.

## 9 Important Rules

**Six Simple rules to ensure reliable and repeatable performance of your induction unit:**

- Keep kitchen temperature below 105°F (40°C).
- Never place your induction units next to any grease generating or heat generating equipment.
- Clean the intake filter at least once a week or as often as required.
- Use only pans that fits the glass, do not use oversized pans.
- Never pre-heat the pan. Place the pan on the cooking area only when you are ready to cook.
- Do not use dented pans; it will cause damages to the electronics.

# 10 Troubleshooting



Do not open the induction unit – dangerous electric voltage inside!  
The induction unit may only be opened by an authorized service personnel.

## CAUTION

**STOP** and **DO NOT USE** the induction unit if any part of the unit is cracked or broken. Turn off the induction unit immediately and if possible and safe, disconnect the unit from the power supply. Do not touch any parts inside the unit.

## 10.1 Common causes for induction unit failure

One or more of the following conditions may affect the function or contribute to the failure of the induction unit:

- Using unsuitable cookware such as non-induction pans or oversized pans.
- High ambient temperature.
- Inadequate ventilation causing hot air to re-enter the induction unit through the air intake slots.
- Dirty air intake filter.
- Empty pans are left on the cook-top when the unit is ON.

### Symptoms

When a malfunction occurs, the induction unit may be in one of the following states:

- The induction unit stops working immediately.
- The induction unit continues to work in a power reduction mode.
- The induction unit continues to work as usual.

When the display shows an error code (e.g. E04), record the error code and contact your authorized service agency.

### Corrective steps

Use the following sections to locate the problem area(s) and to take only the corrective action(s) indicated. Ensure you exercise safety precautions at all time.

Only an authorized service technician would have the training and correct tools to diagnose the internal components accurately and thoroughly. Contact a Factory Authorized Service agency for assistance. For a list of Garland authorized service agencies, please visit our website [www.garland-group.com](http://www.garland-group.com).

## 10.2 Problems and Possible Causes

Problem	Possible Causes	Action To Take By Operator
<b>Pan does not heat, 7-segment display is OFF (dark)</b>	No power supply.	Check the electrical supply, e.g. power cable plugged into the wall socket. Check primary fuses.
	Control knob is in OFF-position.	Turn control knob to an ON-position.
	Defective induction unit.	Ensure knob is in OFF-position and if possible and safe, disconnect the unit from the power supply. Contact your authorized service agency.
<b>Pan does not heat. If an error code is shown, see next section.</b>	Pan is too small.	Use a suitable pan with bottom diameter larger than 5" (12cm).
	Pan is not placed in the heating zone; pan is not detected by sensor.	Place the pan in the center of the heating zone.
	Unsuitable pan.	Select a pan recommended for the induction unit.
<b>Poor heating, 7-segment display is ON (shining).</b>	Defective induction unit.	Ensure knob is in OFF-position and if possible and safe, disconnect the unit from the power supply. Contact your authorized service agency.
	Pan is not suitable.	Select a pan recommended for the induction unit. Then compare the results.
	Air-cooling system obstructed.	Verify that air inlet and outlet are not obstructed. Ensure the Intake Air Filter is clean.
	Ambient temperature is too high; the cooling system is not able to keep the induction unit in normal operating conditions.	Verify that no hot air is sucked in by the fan. Reduce the ambient temperature. The intake air temperature must be lower than 104°F (40°C).
<b>Unit does not react to control knob positions</b>	Defective induction unit.	Ensure knob is in OFF-position and if possible and safe, disconnect the unit from the power supply. Contact your authorized service agency.
	Defective control switch.	Ensure knob is in OFF-position and if possible and safe, disconnect the unit from the power supply. Contact your authorized service agency.
<b>Power/heating level seems to be reduced, fan is working</b>	Air-cooling system is blocked. Internal fan is dirty.	Verify that air inlet and outlet are not obstructed. Ensure the Intake Air Filter is clean. Contact your authorized service agency.
<b>Power/heating level seems to be reduced, fan does not work</b>	Defective fan or fan control.	Ensure knob is in OFF-position and if possible and safe, disconnect the unit from the power supply. Contact your authorized service agency.
<b>After a longer permanent operating time, Power/heating level seems to be reduced</b>	Overheated induction coil; cooking area is too hot. Overheated oil in pan. Pan is empty.	Switch the unit off. Safely remove pan. Wait until the heating zone has cooled down before turning the unit ON again.
<b>Small metallic objects (e.g. spoon) are heated up on the glass top.</b>	Pan detection circuit is defective.	Ensure knob is in OFF-position and if possible and safe, disconnect the unit from the power supply. Contact your authorized service agency.

**NOTE:** The fan starts when the ambient temperature in the control area exceeds 131°F/55°C. At heat temperatures higher than 158°F/70°C, the controller automatically reduces the power to keep the unit in normal operating conditions. The cooker runs in a non-continuous mode. This mode can be heard.

### 10.3 Troubleshooting with Error Codes (for Service Technicians)

To obtain the internal data and error code for troubleshooting, you need an IR Adapter, proper connectors, and software. The table below is a reference guide. For further information and assistance, please contact Garland Technical Service.

Error Code	Possible cause	Action to take
E03 -...-...	Overheated heat sink	Let unit cool down Check air filter and air flow
	Air-cooling system obstructed	Verify that air inlet and outlet are not obstructed with objects. Clean air filter
E04 -...-...	Overheated heating zone	Let unit cool down. Check air filter and air flow
E05 -...-...	Error on power switch	Check potentiometer and its wiring.
E06 -...-...	Overheated electronic	Let unit cool down. Check air filter and air flow
	Ambient temperature too high (the cooling system is not able to keep the unit in normal operating conditions)	Verify that no hot air is sucked in by the fan Reduce the ambient temperature, the air inlet temperature must be lower than 40°C/110°F
E10 -...-...	Communication BUS	Check all wiring.
E12 -...-...	Warning temperature heat sink	Reduce the adjusted temperature Reduce the ambient temperature, the air inlet temperature must be lower than 40°C/110°F Verify that air inlet and air outlet are not obstructed with objects Check fan function
E30 -...-...	Interior temperature too high (central unit)	Reduce the adjusted temperature Reduce the ambient temperature, the air inlet temperature must be lower than 40°C/110°F Verify that air inlet and air outlet are not obstructed with objects Check fan function
E41 -...-...	Overheated Temperature-Sensor1	Let unit cool down. Reduce the adjusted temperature. Check sensor 1.
E42 -...-...	Overheated Temperature-Sensor2	Let unit cool down. Reduce the adjusted temperature. Check sensor 2.
E43 -...-...	Overheated Temperature-Sensor3	Let unit cool down. Reduce the adjusted temperature. Check sensor 3.
E44 -...-...	Overheated Temperature-Sensor4	Let unit cool down. Reduce the adjusted temperature. Check sensor 4.
E45 -...-...	Overheated Temperature-Sensor5	Let unit cool down. Reduce the adjusted temperature. Check sensor 5.

## CORRECT DISPOSAL OF THIS PRODUCT



This marking  shown on the product indicates that the product should not be disposed as household waste or regular commercial waste. Instead it shall be handed over to the applicable collection point for the recycling of electrical and electronic equipment. By ensuring this product is disposed correctly, you will help prevent potential harm to the environment or human health, which could otherwise be caused by inappropriate waste handling of this product.

For more detailed information regarding recycling of the product, please contact your local city office, your waste disposal service or your equipment dealer.

**IMPORTANT** Induction units, sent for disposal, can be brought back into operation and their use should be avoided.

**NOTE** The unit is built with common electrical, electromechanical, and electronic parts. No batteries are used.

**NOTE** The owner and operator are responsible for the proper and safe disposal of the induction unit.

# **Garland** Installation & Operation Manual

---

GARLAND TABLETOP TEMPERATURE CONTROLLED INDUCTION HOLD-LINE with RTCSmp TECHNOLOGY

Garland Commercial Ranges Ltd.  
1177 Kamato Road, Mississauga,  
Ontario, CANADA L4W 1X4

T. 1-905-624-0260  
F. 1-905-624-5669  
[www.garland-group.com](http://www.garland-group.com)

USA Sales, Parts and Service 1-800-424-2411  
Canadian Sales 1-888-442-7526  
Canada or USA Parts/Service 1-800-427-6668

