



Microwave Combination Oven

Part number: 32Z3933 (USA/CA)

 **Read instructions before use**

Approvals:



Language: **ENGLISH**

Expanding your Opportunities

IMPORTANT SAFETY INSTRUCTIONS

All appliances

When using electrical appliances, basic safety precautions should be followed including the following.

WARNING – To reduce the risk of burns, electric shock, fire, injury to persons, or exposure to excessive microwave energy:

- 1) Read all instructions before using the appliance.
- 2) Read and follow the specific 'PRECAUTIONS TO AVOID POSSIBLE EXPOSURE TO EXCESSIVE MICROWAVE ENERGY' on page 3.
- 3) The appliance must be grounded. **Connect only to a dedicated branch and properly grounded outlet.**
- 4) Install or locate this appliance only in accordance with the provided installation instructions.
- 5) Some products such as whole eggs and sealed containers – for example, closed glass jars – can explode and should not be heated in this oven.
- 6) Use this appliance only for its intended use as described in the manual. Do not use corrosive chemicals or vapours in this appliance. This type of oven is specifically designed to heat, cook or toast food. It is not designed for industrial or laboratory use.
- 7) The appliance should not be used by children.

This appliance can be used by persons with reduced physical, sensory or mental capabilities, or lack of experience and knowledge, if they have been given supervision or instruction concerning use of the appliance by a person responsible for their safety.

If smoke is observed, switch off or unplug the appliance and keep the door closed in order to stifle any flames.

- 8) Do not operate this appliance if it has a damaged door, cord or plug, if it is not working properly, or it has been damaged or dropped.

If the supply cord is damaged, it must be replaced by the manufacturer, its service agent or similarly qualified persons in order to avoid a hazard.

- 9) This appliance should be serviced only by qualified service personnel. Contact nearest authorised service facility for examination, repair, or adjustment.
- 10) Do not block or cover any openings on the appliance.
- 11) Do not store this appliance outdoors. Do not use this product near water, for example, near a kitchen sink, in a wet basement, near a swimming pool, or similar locations.
- 12) Do not immerse cord or plug in water.
- 13) Keep cord away from heated surfaces.
- 14) Do not let cord hang over edge of table or counter.
- 15) The oven should be cleaned daily, follow the cleaning procedures in section 9 of this manual. Failure to maintain the oven in a clean condition could lead to deterioration of the surface that could adversely affect the life of the appliance and possibly result in a hazardous situation.

The appliance must not be cleaned with a steam cleaner.

16) To reduce the risk of fire in the oven cavity:



- i. do not overcook food. Carefully attend appliance when paper, plastic, or other combustible materials are placed inside the oven to facilitate cooking.
- ii. remove wire twist-ties from paper or plastic bags before placing a bag in the oven.
- iii. if materials inside the oven ignite, keep the oven door closed. Turn the oven off, and disconnect the supply cord, or shut off power at the fuse or circuit breaker panel.
- iv. do not use the cavity for storage purposes. Do not leave paper products, cooking utensils or food in the cavity when not in use.
- v. when heating food in plastic or paper containers, keep an eye on the oven due to the possibility of ignition.



17) Liquids, such as water, coffee or tea are able to be overheated beyond the boiling point without appearing to be boiling. Visible bubbling or boiling when the container is removed from the microwave combination oven is not always present. THIS COULD RESULT IN VERY HOT LIQUIDS SUDDENLY BOILING OVER WHEN THE CONTAINER IS DISTURBED OR A UTENSIL IS INSERTED INTO THE LIQUID.

Combination microwave ovens

- 1) Oversized foods or oversized metal utensils should not be inserted in a microwave oven as they may create a fire or risk of electric shock.
- 2) Do not clean with metal scouring pads. Pieces can burn off the pad and touch electrical parts involving a risk of electric shock.
- 3) Do not store any materials, other than the manufacturer's recommended accessories in this oven when not in use.
- 4) Do not cover racks or any other part of the oven with metal foil. This will cause overheating of the oven.



SAVE THESE INSTRUCTIONS

	<p>WARNING</p> <p>Improper installation, adjustment, alteration, service or maintenance can cause property damage, injury and death. Read the installation, operating and maintenance instructions thoroughly before installing or servicing this equipment.</p>
	<p>WARNING</p> <p>PRECAUTIONS TO AVOID POSSIBLE EXPOSURE TO EXCESSIVE MICROWAVE ENERGY</p> <ul style="list-style-type: none"> ▶ Do not attempt to operate this oven with the door open since open-door operation can result in harmful exposure to microwave energy. It is important not to defeat or tamper with the safety interlocks. ▶ Do not place any object between the oven front face and the appliance door or allow soil or cleaner residue to accumulate on sealing surfaces. ▶ Do not operate the oven if it is damaged. It is particularly important that the oven door closes properly and that there is no damage to the (1) door (bent), (2) hinges and latches (broken or loosened), (3) door seals and sealing surfaces. ▶ The oven should not be adjusted or repaired by anyone except properly qualified service personnel.
	<p>WARNING</p>

	Disconnect power at the main external power switch before servicing or repairing a microwave combination oven.
	WARNING To reduce the risk of electric shock, do not remove or open cover. No user serviceable parts inside. Refer servicing to qualified personnel. Disconnect power supply before servicing.
	WARNING This is a class A product. In a domestic environment this product may cause radio interference in which case the user may be required to take adequate measures.



■ Mandatory warning signs

The following warning signs / notices must be attached to the microwave combination oven and optional accessories in the area indicated so as to be easily visible at all times.

Warning sign	Description
	Microwaves warning There is a risk of external and internal burns of body parts following exposure to microwave energy.
	Hot surface warning There is a risk of burns from high temperatures inside the cavity and on the inside of the appliance door.

■ Safety symbols

The following safety symbols be attached to the microwave combination oven in the area indicated so as to be easily visible at all times.

Safety symbol	Description
	Protective Earth (Ground)
	Equipotential bonding

Customer documentation

- The customer documentation is part of the microwave combination oven.
- Keep the customer documentation manuals handy at all times so that you can look up any required information.
- Keep the customer documentation manuals for the entire life of the appliance.
- Carefully read the Installation and User Manual before using, handling, and working on this appliance.
- If you transfer the microwave combination oven to a new owner, make sure to give the new owner the customer documentation manuals as well.

CONSIGNES DE SÉCURITÉ IMPORTANTES

Tous les appareils

Lorsque vous utilisez des appareils électriques, vous devez toujours suivre des précautions de base, dont les suivantes.

AVERTISSEMENT – Afin de réduire les risques de brûlures, de décharge électrique, d'incendie, de blessure ou d'exposition à un excès d'énergie dégagée par les micro-ondes :

- 1) Lisez toutes les consignes avant d'utiliser l'appareil.
- 2) Lisez et respectez plus précisément les « PRÉCAUTIONS À PRENDRE POUR ÉVITER TOUTE EXPOSITION POTENTIELLE À UN EXCÈS D'ÉNERGIE DÉGAGÉE PAR LES MICRO-ONDES » à la page 3.
- 3) L'appareil doit être mis à la terre. **Branchez l'appareil uniquement dans une prise de courant dédiée et correctement mise à la terre.**
- 4) Installez ou placez cet appareil seulement conformément aux instructions d'installation fournies.
- 5) Certains produits, comme les œufs entiers et les contenants scellés comme les bocaux de verre fermés, peuvent exploser et ne doivent pas être chauffés dans ce four à micro-ondes.
- 6) Utilisez cet appareil uniquement pour son usage prévu, tel qu'il est décrit dans le manuel. N'utilisez pas de produits chimiques corrosifs ou de produits dégagant des vapeurs corrosives dans cet appareil. Ce type de four est conçu spécialement pour chauffer, cuire ou griller des aliments. Il n'est pas conçu pour un usage industriel ou de laboratoire.
- 7) L'appareil ne doit pas être utilisé par des enfants.

Cet appareil peut être utilisé par des personnes avec des capacités physiques, sensorielles ou mentales réduites, ou qui manquent d'expérience ou de connaissances, à condition que quelqu'un les surveille ou qu'elles aient reçu des instructions concernant l'utilisation de cet appareil par une personne responsable de leur sécurité.

En cas d'apparition de fumée, éteignez ou débranchez l'appareil et gardez la porte fermée pour étouffer les flammes éventuelles.

- 8) N'utilisez pas cet appareil si la porte, le cordon ou la fiche est endommagé, s'il ne fonctionne pas correctement, s'il a été endommagé ou a subi une chute.

Si le cordon d'alimentation est endommagé, il doit être remplacé par le fabricant, un représentant du service ou une personne similairement qualifiée afin de prévenir tout danger.

- 9) Cet appareil doit être réparé uniquement par un technicien qualifié. Communiquez avec le centre de réparation autorisé le plus près pour un examen, une réparation ou un réglage.
- 10) Ne couvrez pas et ne bloquez pas toute ouverture de l'appareil.
- 11) N'entreposez pas cet appareil à l'extérieur. N'utilisez pas cet appareil près de l'eau, par exemple, près d'un évier de cuisine, dans un sous-sol humide, près d'une piscine ou dans un endroit semblable.
- 12) Ne plongez pas le cordon ou la fiche dans l'eau.





- 13) Conservez le cordon à l'écart des surfaces chaudes
- 14) Ne laissez pas le cordon pendre sur le bord d'une table ou d'un comptoir.
- 15) Nettoyez le four quotidiennement en suivant les procédures de nettoyage décrites à la section 9 du présent manuel.
Tout manquement à maintenir le four propre peut conduire à détériorer la surface, ce qui en retour peut influencer sur la durée de vie de l'appareil et éventuellement déboucher sur une situation dangereuse.

L'appareil ne doit pas être nettoyé avec un nettoyeur à vapeur.
- 16) Pour réduire les risques d'incendie dans l'espace intérieur du four :
 - i. Ne faites pas trop cuire les aliments. Surveillez attentivement l'appareil lorsque du papier, du plastique ou d'autres matériaux combustibles sont placés à l'intérieur du four pour faciliter la cuisson.
 - ii. Retirez les attaches torsadées avec fil métallique de tout sac en papier ou en plastique avant de placer le sac dans le four à micro-ondes.
 - iii. Si les matières à l'intérieur du four s'enflamment, gardez la porte fermée. Arrêtez le four et débranchez le cordon d'alimentation ou coupez l'alimentation au fusible ou au panneau du disjoncteur de protection.
 - iv. N'utilisez pas l'espace intérieur à des fins d'entreposage. Ne laissez pas d'articles en papier, d'ustensiles de cuisson ou de nourriture à l'intérieur de l'appareil lorsqu'il n'est pas utilisé.
 - v. En réchauffant des aliments dans des conteneurs en plastique ou en carton, surveillez le four en raison des risques que ces matières prennent feu.
- 17) Les liquides comme l'eau, le café ou le thé peuvent chauffer au-delà du point d'ébullition sans sembler bouillir. Des bulles ou des bouillons ne sont pas toujours visibles ou présents quand le contenant est sorti du four combiné à micro-ondes. CELA PEUT ENTRAÎNER UN DÉBORDEMENT DE LIQUIDE BOUILLANT ET TRÈS CHAUD LORSQUE LE CONTENANT EST DÉPLACÉ OU QU'UN USTENSILE Y EST INSÉRÉ.

Fours combinés à micro-ondes

- 1) Des aliments trop grands ou des ustensiles métalliques de grande dimension ne doivent pas être insérés dans un four à micro-ondes, car ils risquent de provoquer un incendie ou une décharge électrique.
- 2) Ne nettoyez pas l'appareil à l'aide de tampons à récurer en métal. Des morceaux pourraient se détacher du tampon et toucher des pièces électriques, ce qui présenterait un risque de décharge électrique.
- 3) N'entrez pas de matières autres que les accessoires recommandés par le fabricant dans ce four quand il n'est pas en cours d'utilisation.
- 4) Ne recouvrez pas les grilles ni toute autre partie du four de feuille métallique. Ceci ferait surchauffer le four.

CONSERVEZ CES INSTRUCTIONS

	<p>AVERTISSEMENT</p> <p>Toute opération incorrecte dans l'installation, le réglage, la modification, l'entretien ou la réparation peut causer des dommages matériels, des blessures voire la mort. Lisez attentivement les instructions d'installation, d'utilisation et d'entretien avant d'installer ou d'intervenir sur ce matériel.</p>
	<p>AVERTISSEMENT</p> <p>PRÉCAUTIONS POUR ÉVITER UNE POSSIBLE EXPOSITION EXCESSIVE À L'ÉNERGIE MICRO-ONDE</p> <ul style="list-style-type: none"> ▶ Ne tentez pas de faire fonctionner ce four avec la porte ouverte, car cela peut entraîner une exposition nocive à l'énergie dégagée par les micro-ondes. Il est important de ne pas abîmer ou altérer les blocages de sécurité. ▶ Ne placez aucun objet entre la face avant du four et la porte, et ne laissez jamais des résidus de nourriture ou de produits d'entretien s'accumuler sur les surfaces d'étanchéité. ▶ N'utilisez pas le four s'il est endommagé. Il est particulièrement important que la porte du four ferme correctement et que les éléments suivants ne soient pas endommagés : (1) porte (pliée), (2) charnières et loquets (brisés ou desserrés), (3) joints de porte et surfaces d'étanchéité. ▶ Le four ne doit pas être modifié ou réparé par quiconque, sauf un technicien qualifié.
	<p>AVERTISSEMENT</p> <p>Débranchez l'alimentation par l'interrupteur externe principal avant toute intervention ou réparation sur un four combiné à micro-ondes.</p>
	<p>AVERTISSEMENT</p> <p>Pour réduire les risques de décharge électrique, ne retirez pas et n'ouvrez pas le couvercle. Il n'y a aucune pièce pouvant être réparée par l'utilisateur à l'intérieur. Confiez toute intervention à du personnel qualifié. Débranchez l'alimentation avant toute intervention.</p>
	<p>AVERTISSEMENT</p> <p>Produit de classe A. Dans un environnement domestique, ce produit peut occasionner des interférences radio imposant à l'utilisateur de prendre des mesures adéquates.</p>

■ Panneaux avertisseurs obligatoires

Les panneaux et étiquettes d'avertissement doivent être fixés au four combiné à micro-ondes et aux accessoires en option dans la zone indiquée, de sorte à être facilement visibles en permanence.

Panneau avertisseur

Description





Alerte micro-ondes
Risque de brûlures externes et internes de parties du corps suite à l'exposition à l'énergie du micro-ondes.



Avertissement de surface chaude
Risque de brûlures par les hautes températures présentes dans l'espace intérieur et à l'intérieur de la porte de l'appareil.

■ Symboles de sécurité

Les symboles de sécurité suivants doivent être fixés au four combiné à micro-ondes dans la zone indiquée, de sorte à être facilement visibles en permanence.

Symbole de sécurité	Description
	Terre de protection (mise à la terre)
	Liaison équipotentielle

Documentation client

- La documentation client fait partie du four combiné à micro-ondes.
- Tenir à tout instant les manuels de la documentation client à portée de main, de sorte à pouvoir consulter toute information nécessaire.
- Conserver les manuels de la documentation client durant toute la durée de vie de l'appareil.
- Lire soigneusement le manuel d'installation et d'utilisation avant d'utiliser, de manipuler et de travailler sur cet appareil.
- Si le four combiné à micro-ondes est transféré à un nouveau propriétaire, s'assurer de donner également à ce dernier les manuels de la documentation.

Contents

1	General information	7
1.1	CE and UKCA declarations of conformity	7
1.1.1	CE declaration of conformity	7
1.1.2	UKCA declaration of conformity	7
1.2	Environmental protection	7
1.3	Important Information	8
1.4	Identifying your microwave combination oven	8
1.5	Structure of customer documentation	9
1.6	About this Installation and User Manual	9
2	Design and function	11
2.1	Design and function of the microwave combination oven	11
2.2	Layout and function of the operating panel	12
3	For your safety	13
3.1	Basic safety code	13
3.2	Intended use of your microwave combination oven	13
3.3	Warning signs on your microwave combination oven	14
3.4	Summary of hazards	15
3.5	Safety devices	16
3.6	Requirements to be met by personnel and working positions	17
3.7	Personal protective equipment	18
4	Moving the appliance	20
4.1	Working safely with the appliance	20
4.2	Moving the appliance to the installation location	21
5	Setting up the appliance	22
5.1	Safe working when setting up the appliance	22
5.2	Requirements for the installation location	23
5.3	Unpacking the appliance	25
5.4	Taking the appliance off the pallet	27
5.5	Mounting an appliance on a work surface	28
6	Installation	29
6.1	Safe working during electrical installation	29
6.2	Planning the electrical installation	29
6.3	Electrical installation requirements	31
7	Preparing the appliance for use	33
7.1	Safe working when preparing the appliance for use	33
7.2	Procedure for preparing the appliance for use	34
7.3	Main menu screen	36
7.4	The keyboard screen	37

8	Cooking procedures	38
8.1	Operating principles and instructions for cooking	38
8.1.1	Working safely with the appliance	38
8.1.2	Turning the oven on and off	39
8.1.3	How to cook	40
8.2	Operation instructions: Full serve mode	42
8.2.1	The Press&Go Menu	42
8.2.2	Using a cooking profile	43
8.2.3	Creating a cooking profile	45
8.2.4	Using a cooking profile	48
8.2.5	Managing cooking profile groups	52
8.2.6	Basic settings of your microwave combination oven	56
8.2.7	Using a USB stick	65
9	Cleaning procedures	67
9.1	Daily cleaning tasks	67
9.2	Cleaning chemicals	67
9.3	Items required for cleaning	68
9.4	Safe working when cleaning	68
9.5	Cleaning procedures	70
9.5.1	Cool down procedure before cleaning	70
9.5.2	Cleaning instructions	73
10	Taking the appliance out of operation and disposal	78
10.1	Safe working when taking the appliance out of operation	78
10.2	Taking the appliance out of operation and disposal	79
11	Technical data	80
11.1	Technical data	80
11.2	Dimensional drawings	82
12	Servicing information	83
12.1	Warranty information and contacting customer service	83
12.2	Rectifying faults: problems in operation	84

1 General Information

Purpose of this chapter

This chapter shows you how to identify your microwave combination oven and provides guidance on using this manual.

1.1 CE and UKCA declarations of conformity

1.1.1 CE declaration of conformity



The manufacturer declares that the Microwave Combination Oven complies with the following European Directives:

- 2006/42/EC (Machinery Directive)
- 2014/30 (EMC Directive)
- 2011/65/EU (RoHS Directive)
- 2014/53/EU (Radio Equipment Directive)

A full Declaration of Compliance is available on request.

1.1.2 UKCA declaration of conformity



The manufacturer declares that the Microwave Combination Oven specified above complies with the following UK Statutory Instruments:

- UKSI 2008 No. 1597 - Supply of Machinery (Safety) Regulations 2008
- UKSI 2016 No. 1091 - Electromagnetic Compatibility Regulations 2008
- UK SI 2012 No. 3032 - RoHS Regulations 2012
- Radio Equipment Regulations 2017

A full Declaration of Compliance is available on request.

1.2 Environmental protection

Statement of principles

Our customers' expectations, the legal regulations and standards and our company's own reputation set the quality and service for all our products.

We have an environmental management policy that not only ensures compliance with all environmental regulations and laws, but also commits us to continuous improvement of our green credentials.

We have developed a quality and environmental management system in order to guarantee the continued manufacture of high-quality products and to be sure of meeting our environmental targets.

This system satisfies the requirements of ISO 9001:2008 and ISO 14001:2004.

Environmental protection procedures

- We observe the following procedures:
- Use of RoHS2-compliant products
- REACH chemical law
- Recycling of electronic waste
- Environmentally friendly disposal of old appliances via the manufacturer

Join us in our commitment to protect the environment.

1.3 Important information

Users are cautioned that maintenance and repairs should be performed by a Merrychef® authorised service agent using genuine Merrychef® replacement parts. Merrychef® will have no obligation with respect to any product that has been improperly installed, adjusted, operated or not maintained in accordance with national and local codes or installation instructions provided with the product, or any product that has its serial number defaced, obliterated or removed, or which has been modified or repaired using unauthorised parts or by unauthorised service agents. For a list of authorised service agents please refer to your distributor.

1.3 Renseignements importants

Les utilisateurs sont avisés que l'entretien et les réparations doivent être effectués exclusivement par un réparateur Merrychef® agréé et avec des pièces de rechange Merrychef® d'origine. Merrychef® n'aura aucune obligation vis-à-vis de tout produit installé, réglé ou utilisé de façon non conforme ou bien qui n'aurait pas été entretenu conformément aux directives nationales et locales ou aux instructions d'installation fournies avec le produit, ou bien vis-à-vis de tout produit dont le numéro de série serait abîmé, effacé ou retiré, ou qui aurait été modifié ou réparé avec des pièces non autorisées ou par des réparateurs non autorisés. Pour obtenir une liste des réparateurs autorisés, veuillez consulter votre distributeur.

1.4 Identifying your microwave combination oven

Position of nameplate

The nameplate is located on the rear of your microwave combination oven.

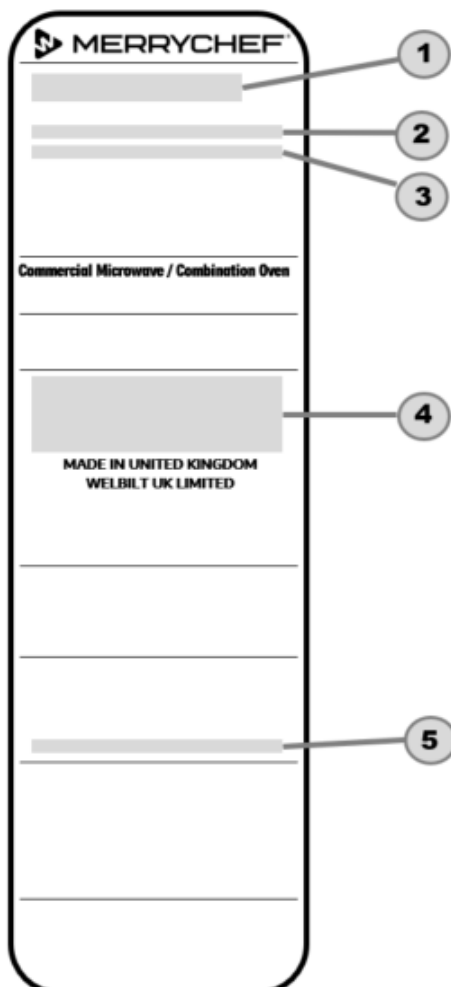

1 Model number

eikon e2s

2 Item Number

Elements of the item number

Model

Power output convection

Power output microwave

Voltage

Frequency

Lead

Plug

Communication

Version

Accessory / Customer

Region / Country

Label

e2s

D

F

G

B

X

30

MV5

MV6

00

20

5

6

A - Z

A - Z

L

U

A, B

1, 2, ...

CF

CL

WW

EU

US

Meaning

2200W

2200W / 1300W

2200W / 900W

2000W (High Power version)

1000W (Standard Power version)

230V

220-230V / 50Hz

208-240V / 60Hz

200V

220V

50Hz

60Hz

Example: H = L+N+E (4mm EU)

Example: E = 32A 1ph plug

USB + LAN

USB

A, B (pre-production)

1, 2, ... (serial production)

"Trend" exterior

"Classic" exterior

Specific customer

Europe

United States of America

3 Serial Number Elements of the serial number	Label	Meaning
Year of manufacture	15	2015
	16, ...	2016, ...
Month of manufacture	01	January
	02, ...	February, ...
Place of manufacture	2130	Sheffield (UK)
Production number	12345	

4 Technical data
5 Date of manufacture

1.5 Structure of customer documentation

Contents of customer documentation

The customer documentation for the microwave combination oven includes the following documents:

- Installation and User Manual (this document)

1.6 About this Installation and User Manual

Purpose

This Installation and User Manual is intended for all people who work with the microwave combination oven and provides them with the necessary information for carrying out installation, operating tasks, cleaning jobs and minor servicing work properly and safely.

Who should read the Installation and User Manual?

Name of target group	Tasks
Equipment mover	Conveying within the establishment.
Service technician	<ul style="list-style-type: none"> ▪ Setting up the appliance. ▪ Preparing the appliance for first-time use and taking the appliance out of service. ▪ Instructing the user.
Owner of the microwave combination oven or Owner's member of staff who is responsible for the appliance	<ul style="list-style-type: none"> ▪ Made aware of all safety-related functions and devices of the microwave combination oven by the service technician. ▪ Instructed by the service technician on how to operate the appliance. ▪ Provides assistance as instructed with conveying the appliance within the establishment and setting up the appliance.
User	<p>Essentially performs specific operating tasks such as</p> <ul style="list-style-type: none"> ▪ Loading the microwave combination oven. ▪ Starting cooking profiles. ▪ Removing food. ▪ Cleaning the microwave combination oven. ▪ Fitting accessories in the microwave combination oven. ▪ Minor servicing tasks.

■ Parts of this documentation that must be read without fail**If you do not follow the information in this document, you risk potentially fatal injury and property damage.**

To guarantee safety, all people who work with the microwave combination oven must have read and understood the following parts of this document before starting any work:

- The chapter '*For your safety*' on page 12
- The sections that describe the activity to be carried out

■ Parties du présent document à lire impérativement**En ne suivant pas les informations données dans le présent document, vous vous exposez à des blessures potentiellement mortelles ainsi qu'à des dommages matériels.**

Afin de garantir la sécurité, toute personne travaillant sur le four combiné à micro-ondes doit avoir lu et compris les parties suivantes du présent document avant de commencer tout travail :

- Le chapitre « *Pour votre sécurité* » à la page 12
- Les sections décrivant l'activité à effectuer

■ Chapters in the Installation and User Manual

Chapter/section	Purpose
General information	<ul style="list-style-type: none"> ▪ Shows you how to identify your appliance. ▪ Provides guidance on using this Installation and User Manual.
Design and function	<ul style="list-style-type: none"> ▪ Specifies the intended use of the appliance. ▪ Explains the functions of the appliance and shows the position of its components.
For your safety	<ul style="list-style-type: none"> ▪ Describes the hazards posed by the appliance and suitable preventive measures. ▪ It is important that you read this chapter carefully.
Moving the appliance	<ul style="list-style-type: none"> ▪ Specifies the basic appliance dimensions. ▪ Specifies the requirements for the installation position. ▪ Explains how to convey the appliance to the installation position.
Setting up the appliance	<ul style="list-style-type: none"> ▪ Explains how to unpack the appliance and specifies the parts supplied with the appliance. ▪ Explains how to set up the appliance.
Installation	Provides information on installing the electrical supply.
Preparing the appliance for use	Explains the procedure for preparing the appliance for first-time use.
Cooking procedures	<ul style="list-style-type: none"> ▪ Explains how to switch on the microwave combination oven. ▪ Contains the instructions for working procedures during cooking. ▪ Contains the instructions for handling operations on the microwave combination oven regularly performed during cooking.
Cleaning procedures	<ul style="list-style-type: none"> ▪ Contains the cleaning instructions. ▪ Describes the cleaning chemicals. ▪ Contains and refers to the instructions for handling operations on the microwave combination oven regularly performed during cleaning.
Taking the appliance out of operation and disposal	<ul style="list-style-type: none"> ▪ Explains the procedure for taking the appliance out of service. ▪ Contains information on disposal.
Technical data	Contains the technical data and dimensional drawings.
Servicing information	Contains Warranty information and a key to rectifying problems in operation.

2 Design and function

Purpose of this chapter

This chapter describes the design and construction of the microwave combination oven and explains its functions.

2.1 Design and function of the microwave combination oven

Parts and their function

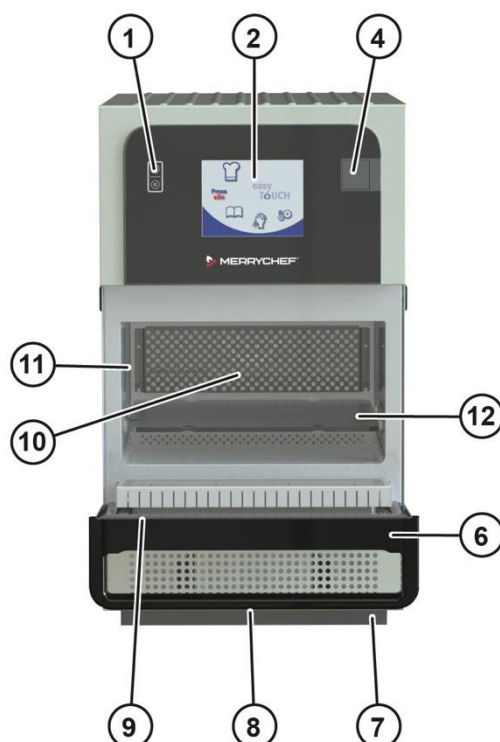

Item	Name	Function
1	ON/OFF appliance switch	Used to turn the microwave combination oven on and off. Turning this switch off does not isolate the appliance from the electricity supply.
2	easyToUCH® screen control panel	When the appliance is switched on the easyToUCH® screen illuminates the user interface. See 'Cooking procedures' on page 38 for details.
3	Nameplate (no picture)	Located on the rear panel of the appliance, the nameplate states the serial number, model type and electrical specifications.
4	USB port	A USB socket located under the cover allows updates to programs stored on the appliance. See USB MenuConnect® Operating Instructions. See 'Cooking procedures' on page 38 of this manual, for details of updating cooking profiles.
5	Air outlets (no picture)	Air used to cool internal components and steam from the cavity escape through the air outlet vents located on the rear of the appliance. The air outlets must be kept free from obstruction and they will not allow microwave energy to escape into the environment.
6	Appliance door	The door is a precision-made energy barrier with three microwave safety interlocks. Always keep it clean and do not use it to support heavy objects. See 'Cleaning procedures' on page 67.

Item	Name	Function
7	Air filter	The air filter situated at the lower front of the appliance is part of the ventilation system. Keep it free of obstruction and clean it daily as described under ' <i>Cleaning procedures</i> ' on page 67. The appliance should not be operated without the air filter fitted.
8	Door handle	The door handle is a rigid bar which is pulled downwards and away from the appliance to open it.
9	Door seals	The door seals ensure a tight seal around the door. Always keep them clean and check regularly for signs of damage. At the first sign of wear have them replaced by a Merrychef® approved service agent. See ' <i>Cleaning procedures</i> ' on page 67.
10	Air diffuser (not fitted to all appliances)	Keep the air diffuser clean and free of debris. Take great care when cleaning this area of the appliance noting the different requirements shown under ' <i>Cleaning procedures</i> ' on page 67 in this manual.
11	Cavity	The cavity (cooking chamber) is constructed from stainless steel and used for cooking products. Keep it clean by following the cleaning instructions in the ' <i>Cleaning procedures</i> ' on page 67 section of this manual.
12	Cook plate	The cook plate is flat and square with all four sides having circular dips for easily fitting onto the cavity support stubs (Two on each side). Both sides of the cook plate can be used for cooking and all sides are designed to fit onto the cavity support stubs.

Material

The interior and exterior structure of the appliance is made of stainless steel in either a brushed finish or colour coded.

2.2 Layout and function of the operating panel

Elements and their function

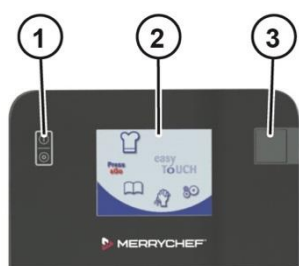

Item	Name	Function
1	ON/OFF appliance switch	Switches the microwave combination oven on and off.
2	Touchscreen	Central controls of the appliance <ul style="list-style-type: none"> ▪ Appliance operated by touching icons on touchscreen pages. ▪ Status displays.
3	USB port	For connecting a USB memory stick.

3 For your safety

■ Purpose of this chapter

Together with Important Safety Instructions on pages 2-3, this chapter provides you with all the information you need in order to use the microwave combination oven safely without putting yourself or others at risk.

This is a particularly important chapter that you must read through carefully.

! 3.1 Basic safety code

■ Object of this safety code

This safety code aims to ensure that all persons who use the microwave combination oven have a thorough knowledge of the hazards and safety precautions, and that they follow the warning notices given in this Installation and User Manual and on the appliance. If you do not follow this safety code, you risk potentially fatal injury and property damage.

! 3.2 Intended use of your microwave combination oven

The microwave combination oven must only be used for the purposes specified below:

- The microwave combination oven is designed and built solely for cooking different foodstuffs in containers approved by the manufacturer. Microwave, convection and impingement are used for this purpose.
- The microwave combination oven is intended solely for professional, commercial use.

■ Restrictions on use

Some materials are not allowed to be heated in the microwave combination oven:

- No dry powder or granulated material.
- No highly flammable objects with a flash point below 275°C / 518°F, such as highly flammable oils, fats or cloths (kitchen cloths).
- No food in sealed tins or jars.

■ Requirements to be met by personnel

- The microwave combination oven must only be operated and installed by personnel who satisfy specific requirements. Please refer to '*Requirements to be met by personnel, working positions*' on page 17 for the training and qualifications requirements.
- Personnel must be aware of the risks and regulations associated with handling heavy loads.

■ Requirements relating to the operating condition of the microwave combination oven

- Do not operate the microwave combination oven unless it has been properly transported, set up, installed and placed into operation as indicated in this manual and the person responsible for placing it into operation has confirmed this.
- The microwave combination oven must only be operated when all safety devices and protective equipment are fitted, in working order and fixed properly in place.
- The manufacturer's regulations for operation and servicing of the microwave combination oven must be observed.

■ Requirements relating to the operating environment of the microwave combination oven

Specified operating environment for the microwave combination oven:

- The ambient temperature lies between +4°C / 40°F and +35°C / 95°F.
- Not a toxic or potentially explosive atmosphere.
- Dry kitchen floor to reduce the risk of accidents.

Specified properties of the installation location:

- No fire alarm, no sprinkler system directly above the appliance.
- No flammable materials, gases or liquids above, on, under or in the vicinity of the appliance.
- It must be possible to set up the microwave combination oven in the installation position so that it cannot tip over or slide about. The supporting surface must comply with these requirements.

Mandatory restrictions on use:

- The appliance must not be operated outdoors and not be shifted or moved during use.

■ Cleaning requirements

- Use only cleaning chemicals that have been approved by the manufacturer.
- High-pressure cleaners or water jets must not be used for cleaning.
- The appliance must not be treated with alkali or acid solutions or exposed to acid fumes.

! 3.3 Warning signs on your microwave combination oven

■ Warning and safety signs

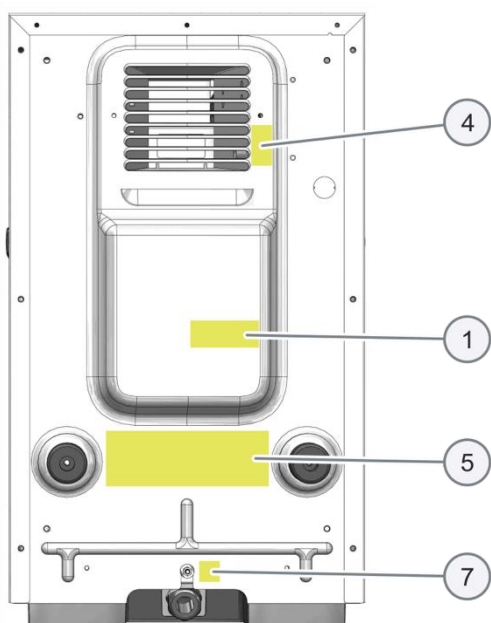
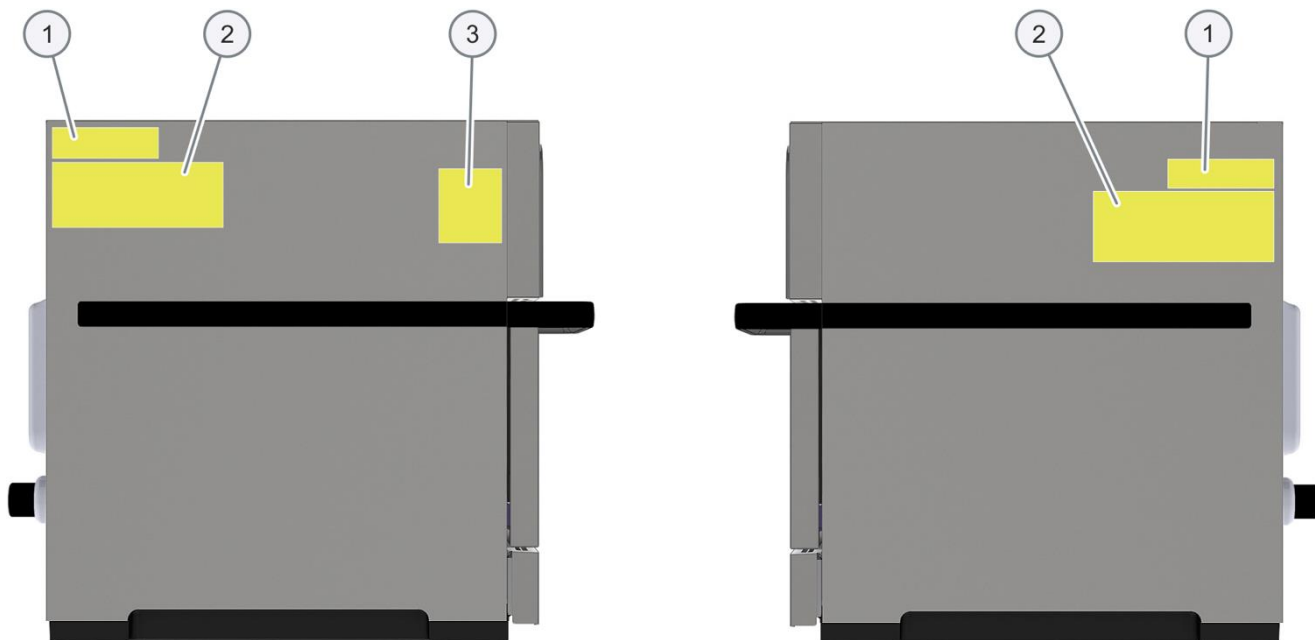



3.4 Summary of hazards

■ General rules for dealing with hazards and safety precautions

The microwave combination oven is designed to protect the user from all hazards that can reasonably be avoided by design measures.

The actual purpose of the microwave combination oven, however, means that there are still residual risks; you must therefore take precautions to avoid them. A safety device can provide you with a certain degree of protection against some of these hazards. You must ensure, however, that these safety devices are in place and in working order.

The nature of these residual risks and what effect they have are described on the following pages.

■ Hazard points

The following illustration shows a Merrychef eikon® e2s microwave combination oven:

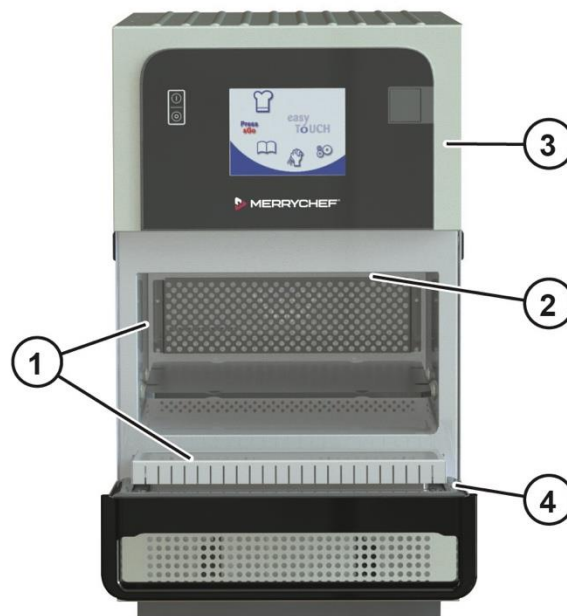

■ Excessive microwave energy

The microwave combination oven generates microwave energy. An operation with an open or damaged door or cavity can result in external and internal burns of body parts following exposure to microwave energy.

■ Heat generation (1)

The microwave combination oven becomes hot inside the cavity and on the inside of the appliance door. This poses a risk of burns on hot surfaces inside the microwave combination oven, and also on hot appliance parts, food containers and other accessories used for cooking.

■ Hot steam / vapour (2)

When cooking food, the microwave combination oven may generate hot steam and vapour which escapes when the appliance door is opened, and which is removed through the air vents on the rear of the microwave combination oven when the appliance door is closed. This poses a risk of scalding from hot steam when the appliance door is opened. Take particular care when opening the appliance door if the top door edge is below your field of vision.

■ Hot liquids

Foodstuffs are cooked in the microwave combination oven. These foodstuffs may also be liquid or liquefy during cooking. This poses a risk of scalding from hot liquids, which may be spilled if not handled properly.

■ Live components (3)

The microwave combination oven contains live parts. This means a risk from live parts if the cover is not in place.

■ Contact with cleaning chemicals

The microwave combination oven must be cleaned using special cleaning chemicals. This poses a risk from cleaning chemicals, some of which can cause skin burns.

■ Parts moving against each other (4)

For various actions, such as opening/shutting the appliance door or cleaning the appliance door, there is the risk that you will crush or cut your hand.

■ Undercooking of food products

Ensure all food is hot before serving to protect your guests from microbiological contamination of foodstuffs.

! 3.4 Résumé des risques

■ Règles générales relatives aux dangers et précautions de sécurité

Le four combiné à micro-ondes est conçu pour protéger l'utilisateur de tous les risques pouvant raisonnablement être évités à l'aide de dispositions de conception.

L'objet même du four combiné à micro-ondes ne peut cependant exclure les risques résiduels; c'est pourquoi il convient de prendre des précautions pour les éviter. Un dispositif de sécurité peut vous offrir un certain degré de protection contre certains de ces risques. Vous devez cependant vous assurer que ces dispositifs de sécurité sont en place et en état de marche.

La nature de ces risques résiduels et des effets qu'ils engendrent sont décrits dans les pages suivantes.

■ Risques

L'image suivante montre un four combiné à micro-ondes Merrychef eikon® e2s :

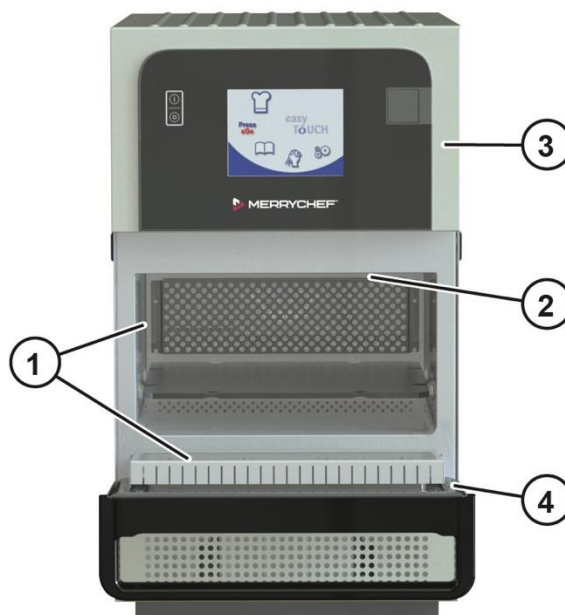

■ Énergie micro-ondes excessive

Le four combiné à micro-ondes génère une énergie micro-ondes. Un fonctionnement alors que la porte ou l'espace intérieur est ouvert ou endommagé peut provoquer des brûlures externes et internes de parties du corps suite à l'exposition à l'énergie du micro-ondes.

■ Production de chaleur (1)

L'espace intérieur et la face intérieure de la porte de l'appareil deviennent chauds durant l'utilisation du four combiné à micro-ondes. Cela pose un risque de brûlure sur les surfaces chaudes à l'intérieur du four combiné à micro-ondes et aussi sur les parties chaudes de l'appareil, les récipients alimentaires et autres accessoires utilisés pour la cuisson.

■ Vapeur d'eau chaude/fumées (2)

Lors de la cuisson des aliments, le four combiné à micro-ondes peut produire de la vapeur d'eau chaude et des fumées s'échappant lorsque la porte de l'appareil est ouverte et qui sont éliminées par les orifices d'évacuation situés à l'arrière du four combiné à micro-ondes lorsque la porte de l'appareil est fermée. Cela pose un risque de brûlure par vapeur chaude à l'ouverture de la porte de l'appareil. Faites particulièrement attention lors de l'ouverture de la porte de l'appareil si le bord supérieur de la porte se situe en-dessous de votre champ de vision.

■ Liquides chauds

Les aliments sont cuits dans le four combiné à micro-ondes. Ces aliments peuvent également être liquides ou se liquéfier lors de la cuisson. Cela pose un risque de brûlure par liquides chauds, lesquels peuvent se répandre s'ils ne sont pas manipulés correctement.

■ Composants sous tension (3)

Le four combiné à micro-ondes contient des pièces sous tension. Ces pièces sous tension entraînent des risques si le couvercle n'est pas en place.

■ Contact avec des produits de nettoyage

Le four combiné à micro-ondes doit être nettoyé à l'aide de produits nettoyants spéciaux. Cela engendre un risque dû aux produits chimiques de nettoyage, car certains d'entre eux peuvent provoquer des brûlures de la peau.

■ Pièces mobiles les unes par rapport aux autres (4)

Lors de différentes actions telles que l'ouverture et la fermeture de la porte, ou le nettoyage de celle-ci, il existe un risque de s'écraser ou de se couper la main.

■ Cuisson insuffisante des aliments

S'assurer que tous les aliments sont chauds avant de les servir, pour protéger vos convives de toute contamination microbologique des ingrédients.



3.5 Safety devices

■ Meaning

The microwave combination oven has a number of safety devices to protect the user from hazards. It is absolutely essential that all safety devices are fitted and in working order when operating the appliance.

■ Position and function

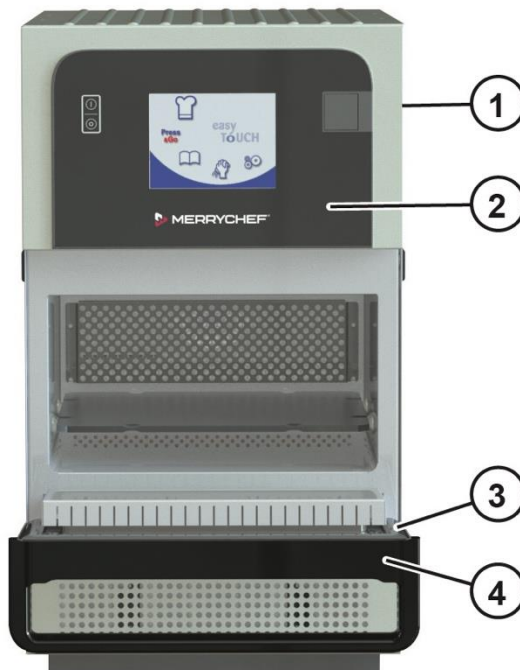

Item	Safety device	Function	Check
1	Covers can only be removed using a tool	<ul style="list-style-type: none"> Prevents live parts from being touched accidentally Prevents access to the moving fan from the wiring compartment 	Check that the covers are in place.
2	Operating panel can only be removed using a tool	Prevents live parts from being touched accidentally	Ensure that the operating panel is in place.
3	Door seal	Protects the user and outside environment from microwave energy leaking from the cavity	Check the door seal regularly for signs of damage and replace it if required.
4	Appliance door	Protects the user and outside environment from hot steam and microwave energy	Check the door regularly for damage and replace it if required.
5 (no picture)	Door interlocks: three switch circuit for the appliance door	Ensures that the microwave generation system cannot be powered when the door is open.	Check door switches: Action: Open the appliance door fully during pre-heat or when the oven is at temperature Result: Door open warning message displayed
6 (no picture, installed by customer)	Disconnection device	<ul style="list-style-type: none"> Installed by the customer close to the appliance; easily visible and accessible, 1- or 3-pole action, minimum contact separation 3 mm. Used to disconnect the appliance from the power supply during cleaning, repair and servicing work and in case of danger 	Action: <ul style="list-style-type: none"> Trip the disconnection device

Item	Safety device	Function	Check
7 (no picture)	Internal fuses	Prevent faulty components from drawing too much current and causing potential fire hazard.	Ensure that the internal fuses are correctly rated, actioned by an authorised service company technician only
8 (no picture)	Internal high temperature thermostats	Prevent faulty components from generating too much heat and causing potential fire hazard	Ensure correct operation, actioned by an authorised service company technician only



3.6 Requirements to be met by personnel and working positions

■ Requirements to be met by operating personnel

Personnel	Qualifications	Tasks
Chef	<ul style="list-style-type: none"> ▪ Has relevant professional training ▪ Knows relevant national food legislation and regulations, plus hygiene legislation and regulations ▪ Must keep records in accordance with HACCP ▪ Trained in how to operate the microwave combination oven 	<p>Essentially performs organizational tasks such as</p> <ul style="list-style-type: none"> ▪ Entering the cooking profile data ▪ Editing existing cooking profiles in the cookbook ▪ Developing new cooking profiles ▪ Adjusting appliance settings <p>May also perform all user tasks if applicable.</p>
User	<ul style="list-style-type: none"> ▪ Semi-skilled ▪ Trained in how to operate the microwave combination oven ▪ Works under supervision ▪ Knows the regulations associated with handling heavy loads 	<p>Essentially performs specific operating tasks such as</p> <ul style="list-style-type: none"> ▪ Loading the microwave combination oven ▪ Starting a cooking profile ▪ Removing food ▪ Cleaning the microwave combination oven ▪ Fitting accessories in the microwave combination oven ▪ Minor servicing tasks
Equipment mover	<ul style="list-style-type: none"> ▪ Trained in the use of a pallet truck and forklift truck ▪ Knows the regulations associated with handling heavy loads 	Conveying within the establishment.
Service technician	<ul style="list-style-type: none"> ▪ Is an authorised service agent ▪ Has relevant technical training ▪ Is trained in the particular appliance ▪ Knows the regulations associated with handling heavy loads 	<ul style="list-style-type: none"> ▪ Setting up the appliance ▪ Preparing the appliance for first-time use and taking the appliance out of service. ▪ Instructing the user

■ Working positions

- The working position for personnel installing and preparing the appliance for first-time use is the entire appliance area.
- The working position for personnel when operating the appliance is in front of the appliance door.
- The working position for staff during cleaning and servicing is the entire appliance area.



3.7 Personal protective equipment

■ Moving and setting up the appliance

Activity	Materials used	Personal protective equipment
<ul style="list-style-type: none"> ▪ Conveying within the establishment ▪ Setting up the appliance on a work surface, stand or in a stacking kit ▪ Setting up the appliance in the installation location 	<ul style="list-style-type: none"> ▪ Suitable lifting gear ▪ Forklift truck or pallet truck 	<ul style="list-style-type: none"> ▪ Protective gloves ▪ Safety boots ▪ Hard hat (e.g., when heavy loads are being lifted, working overhead, ...)

■ Installation, preparing for the first-time use and taking out of service

Activity	Materials used	Personal protective equipment
Installing and removing (taking out of operation) the electrical connection	Tools and equipment depending on the task	Work wear and personal protective equipment depending on the job that needs doing as specified in national regulations.
<ul style="list-style-type: none"> ▪ Preparing the appliance for first-time use ▪ Instructing the user 	Tools and equipment depending on the task	Workwear as specified in country-specific standards and directives for kitchen work, in particular: <ul style="list-style-type: none"> ▪ Protective clothing ▪ Heat protective gloves (compliant with EN 407 in European Union) ▪ Safety boots
Dismantling the appliance (taking out of operation)	<ul style="list-style-type: none"> ▪ Suitable lifting gear ▪ Forklift truck or pallet truck 	<ul style="list-style-type: none"> ▪ Protective gloves ▪ Safety boots ▪ Hard hat (e.g., when heavy loads are being lifted, working overhead).

■ Operation

Activity	Materials used	Personal protective equipment
Loading / removing food	None	Workwear as specified in country-specific standards and directives for kitchen work, in particular: <ul style="list-style-type: none"> ▪ Protective clothing ▪ Heat protective gloves (compliant with EN 407 in European Union) ▪ Safety boots
Removing and fitting parts	Tools and equipment depend on the task	Workwear as specified in country-specific standards and directives for kitchen work, in particular: <ul style="list-style-type: none"> ▪ Protective clothing ▪ Heat protective gloves (compliant with EN 407 in European Union) ▪ Safety boots

■ Cleaning

Activity	Materials used	Personal protective equipment
<ul style="list-style-type: none"> ▪ Cleaning the cavity by hand ▪ Handling spray bottles 	<ul style="list-style-type: none"> ▪ Cleaning chemicals approved by the manufacturer ▪ Protective chemicals approved by the manufacturer 	<p>Items of protection equipment, depending on cleaning chemical being used:</p> <ul style="list-style-type: none"> ▪ Breathing mask ▪ Safety goggles ▪ Protective gloves ▪ Protective clothing/apron <p>The material safety datasheet for the relevant cleaning chemical contains a more precise specification of these items. An up-to-date copy can be obtained from the manufacturer.</p> <p>Refer to the label on the cleaning chemical concerned.</p>
Cleaning components and accessories according to relevant instructions	Common household detergent: mild on skin, alkali-free, pH-neutral and odourless	Follow the instructions given by the manufacturer of the cleaning chemical you are using.
Cleaning the outside of the appliance case	Common household stainless steel cleaner or hard surface cleaner	Follow the instructions given by the manufacturer of the cleaning chemical you are using.

! 3.7 Équipements de protection individuelle

■ Déplacement et mise en place de l'appareil

Activité	Matériaux utilisés	Équipement de protection individuelle
<ul style="list-style-type: none"> ▪ Déplacement dans l'établissement ▪ Mise en place de l'appareil sur un plan de travail, sur un support ou dans une unité de superposition ▪ Mise en place de l'appareil à l'emplacement d'installation 	<ul style="list-style-type: none"> ▪ Dispositifs de manutention adaptés ▪ Chariot élévateur ou transpalette 	<ul style="list-style-type: none"> ▪ Gants de protection ▪ Chaussures de sécurité ▪ Casque (par exemple en cas de levage de charges lourdes, de travaux en hauteur, etc.)

■ Installation, préparation à la première utilisation et mise hors service

Activité	Matériaux utilisés	Équipement de protection individuelle
Installation et suppression (mise hors service) de la connexion électrique	Outils et équipements selon la tâche	Vêtements professionnels et équipements de protection individuelle selon le travail à effectuer, tel que défini dans les réglementations nationales.
<ul style="list-style-type: none"> ▪ Préparation de l'appareil à la première utilisation ▪ Formation de l'utilisateur 	Outils et équipements selon la tâche	<p>Vêtement professionnel tel que défini dans les normes et directives propres au pays concernant le travail en cuisine, en particulier :</p> <ul style="list-style-type: none"> ▪ Vêtements de protection ▪ Gants de protection thermique (conformes à l'EN 407 de l'Union européenne) ▪ Chaussures de sécurité

Activité	Matériaux utilisés	Équipement de protection individuelle
Démontage de l'appareil (mise hors service)	<ul style="list-style-type: none"> ▪ Dispositifs de manutention adaptés ▪ Chariot élévateur ou transpalette 	<ul style="list-style-type: none"> ▪ Gants de protection ▪ Chaussures de sécurité ▪ Casque (par exemple en cas de levage de charges lourdes, de travaux en hauteur, etc.)

■ Utilisation

Activité	Matériaux utilisés	Équipement de protection individuelle
Chargement/retrait des aliments	Aucun	<p>Vêtement professionnel tel que défini dans les normes et directives propres au pays concernant le travail en cuisine, en particulier :</p> <ul style="list-style-type: none"> ▪ Vêtements de protection ▪ Gants de protection thermique (conformes à l'EN 407 de l'Union européenne) ▪ Chaussures de sécurité
Retrait et installation de pièces	Outils et équipements selon la tâche	<p>Vêtement professionnel tel que défini dans les normes et directives propres au pays concernant le travail en cuisine, en particulier :</p> <ul style="list-style-type: none"> ▪ Vêtements de protection ▪ Gants de protection thermique (conformes à l'EN 407 de l'Union européenne) ▪ Chaussures de sécurité

■ Nettoyage

Activité	Matériaux utilisés	Équipement de protection individuelle
<ul style="list-style-type: none"> ▪ Nettoyage de l'espace intérieur à la main ▪ Manipulation des flacons pulvérisateurs 	<ul style="list-style-type: none"> ▪ Produits chimiques de nettoyage approuvés par le fabricant ▪ Produits chimiques de protection approuvés par le fabricant 	<p>Éléments d'équipement de protection, selon le produit nettoyant utilisé :</p> <ul style="list-style-type: none"> ▪ Masque respiratoire ▪ Lunettes de protection ▪ Gants de protection ▪ Vêtement de protection/tablier <p>La fiche signalétique du nettoyant adéquat contient une liste plus détaillée de ces articles. Vous pouvez en obtenir une copie à jour auprès du fabricant. Consultez l'étiquette du produit de nettoyage concerné.</p>
Nettoyage des composants et accessoires selon les instructions correspondantes	Détergent ménager habituel : doux pour la peau, non alcalin, pH neutre et sans odeur	Suivre les instructions données par le fabricant du produit nettoyant utilisé
Nettoyage de l'extérieur de l'appareil	Nettoyant ménager habituel pour inox ou nettoyant pour surface dure	Suivre les instructions données par le fabricant du produit nettoyant utilisé

4 Moving the appliance

■ Purpose of this chapter

Provides information on how to move the appliance.

This chapter is intended for the owner's member of staff responsible for the appliance and for a qualified member of staff from an authorized service company.

4.1 Working safely with the appliance

■ Eligibility of personnel for moving the appliance

Personnel eligible for moving the appliance:

- Only personnel who are trained in the use of a pallet truck and fork-lift truck for handling purposes are permitted to move the appliance.
- Personnel must be aware of the regulations relating to handling heavy loads.

■ Personal protective equipment

Wear the following personal protective equipment specified in the section '*Personal protective equipment*' on page 18 of the '*For your safety*' chapter for the relevant tasks.

■ Moving heavy loads

WARNING

Risk of injury from lifting incorrectly

When lifting the appliance, the weight of the appliance may lead to injuries, especially in the area of the torso.

- ▶ Use a fork-lift truck/pallet truck to move the appliance.
- ▶ When lifting the appliance, use enough people for the weight of the appliance (value depending on age and gender). Observe the local occupational safety regulations.
- ▶ Wear personal protective equipment.

■ Unsuitable supporting surface

WARNING

Risk of crushing if the appliance tips over or falls off

Body parts can be crushed if the appliance tips over or falls off.

- ▶ Make sure that the appliance is never placed on an unsuitable supporting surface.

4.2 Moving the appliance to the installation location

Space required for conveying the appliance

Make sure that there is enough width and height along the entire route used for conveying the appliance to ensure it can get through to its installation location.

The table below shows the dimensions of the **appliance including packaging**, which are needed to determine the minimum doorway dimensions required to allow the appliance to be brought to its installation location:

Minimum door opening

Width	[mm]	535	[in]	21.1
Height	[mm]	850	[in]	33.5
Depth	[mm]	895	[in]	35.3

Load bearing capability for conveying the appliance

Provide moving equipment that is rated capable of carrying the load.

Empty weight of appliance

e2s High Power version	[kg]	61.0	[lbs]	134
e2s Standard Power version	[kg]	51.7	[lbs]	114

Moving the appliance to the installation location

Please observe the following points when conveying the appliance:

- Always move the appliance on a pallet.
- Always move the appliance in an upright position.
- Move the appliance slowly and carefully, and secure it against tipping over.
- Make sure that you do not knock against things with the appliance.
- Avoid moving the appliance along uneven routes or up or down slopes/steps.
- Do not lift the oven by the handle but always use the hand lifting points.

5 Setting up the appliance

■ Purpose of this chapter

Provides information on how to set up your appliance.

This chapter is intended for the user and for a qualified member of staff from an authorized service company.

5.1 Safe working when setting up appliance

■ Eligibility of personnel for setting up the appliance

Personnel eligible for setting up the appliance:

- Only qualified personnel from an authorized service company are permitted to set up the appliance.

■ Regulations for setting up the appliance

Local and national standards and regulations relating to workplaces in catering kitchens must be observed.

The rules and regulations of the local authorities and supply companies that apply to the installation location concerned must be observed.

■ Personal protective equipment

Wear the following personal protective equipment specified in the section '*Personal protective equipment*' on page 18 of the '*For your safety*' chapter for the relevant tasks.

■ Moving heavy loads

WARNING

Risk of injury from lifting incorrectly

When lifting the appliance, the weight of the appliance may lead to injuries, especially in the area of the torso.

- ▶ Use a forklift truck or pallet truck to place the appliance in the installation position or to move it to a new position.
- ▶ When shifting the appliance into the correct position, use enough people for the weight of the appliance when lifting it (value depending on age and gender). Observe the local occupational safety regulations.
- ▶ Wear personal protective equipment.

■ Unsuitable supporting surface

WARNING

Risk of crushing if the appliance tips over or falls off

Body parts can be crushed if the appliance tips over or falls off.

- ▶ Make sure that the appliance is never placed on an unsuitable supporting surface.

5.2 Requirements for the installation location

Meaning

This section contains information to help you choose a suitable installation location for the microwave combination oven. Inspect the intended installation location carefully to ensure it is suitable before taking the appliance there and starting the installation.

⚠ Rules for setting up the appliance safely

To prevent hazards that arise from the installation site and environment of the appliances, the following rules must be observed:

- It must be possible to comply with the operating conditions. For operating conditions, see '*Requirements relating to the operating environment of the microwave combination oven*' on page 12.
- There is a risk of fire from the heat emitted from hot surfaces. Therefore, flammable materials, gases or liquids must not be located near, on or below the appliance. When choosing where to install the appliance it is essential to remember this requirement together with the minimum space required for the appliance.
- Heat sources in the vicinity must lie at a minimum distance of 500 mm / 20 in.
- The appliance must be installed so that there is absolutely no possibility that liquid from the appliance or liquid coming from cooking processes can reach deep-fat fryers or appliances that use hot, uncovered fat. Deep-fat fryers or appliances that use hot, uncovered fat that are located in the vicinity must lie at a minimum distance of 500 mm / 20 in.
- The appliance must not be installed directly under a fire alarm or sprinkler system. Fire alarm installations and sprinkler systems must be set up to handle the level of steam and vapour expected to escape from the appliance when the door is opened.
- It must be possible to set up the supporting structure for the appliance (work surface, stand or stacking kit) in the installation position so that it cannot tip over or slide about. The supporting surface must satisfy the requirements listed below.
- Vibrations must generally be avoided when using wheeled oven stands or wheeled stacking kits.

Requirements for the supporting surface

The supporting surface must have the following properties:

- The supporting surface must be flat and level.
- The supporting surface must be able to bear the in-use weight of the appliance plus the weight of the structure supporting the appliance.
- The structure supporting the appliance (work surface or stand) must be able to bear the in-use weight of the appliance.

Empty weight of appliance

e2s High Power version	[kg]	61.0	[lbs]	134
e2s Standard Power version	[kg]	51.7	[lbs]	114

Actual space requirements

Far more room than the specified minimum space requirement is needed in front of the appliances to operate the microwave combination ovens safely, in particular to handle hot food safely.

Larger wall gaps are generally recommended to provide access for servicing.

In the installation location, the following parts must not be covered, adjusted or blocked (see also '*Design and function of the microwave combination oven*' on page 10):

- Air vent on the rear of the appliance
- Air filter at the front of the appliance

Consideration should be given to allow sufficient access for the service and maintenance of the appliance and access to the power supply isolator.

Minimum space required

The following diagram and table show the space required for the appliance for different installation and operating situations. They also show the minimum horizontal distances from adjacent walls and surfaces. The safety clearance on the top must always be complied with.

Meaning	Space required			
A Safety clearance from the top	[mm]	50	[in]	2
B Depth requirement, appliance door open at 90°	[mm]	310	[in]	12.2
Safety clearance on left-/right-hand side	[mm]	0	[in]	0

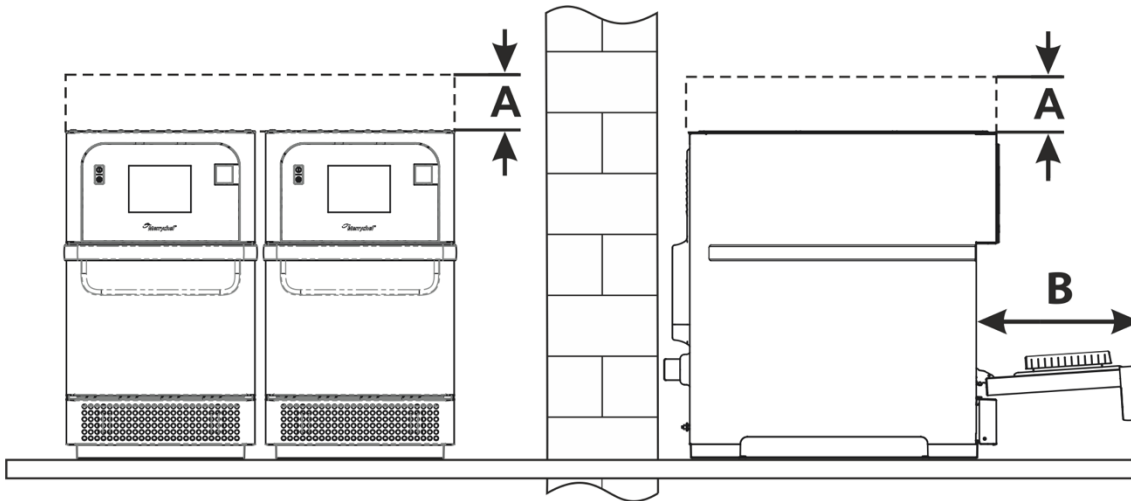

5.3 Unpacking the appliance

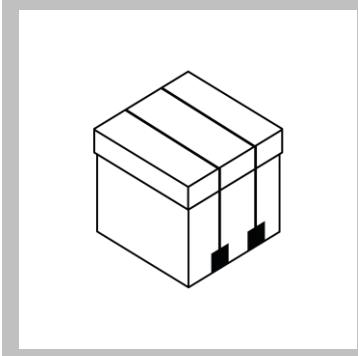
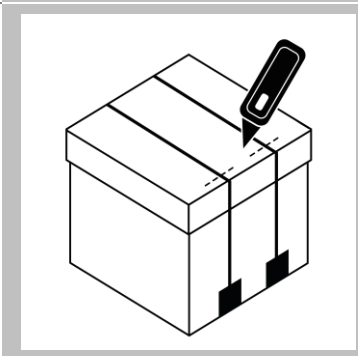
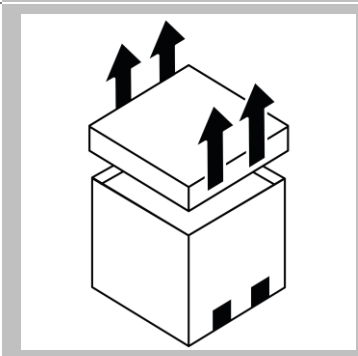
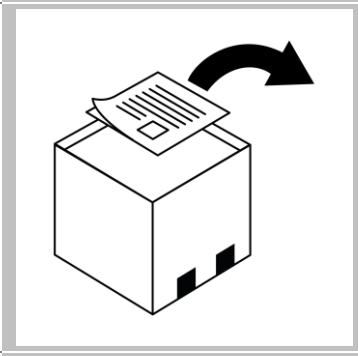
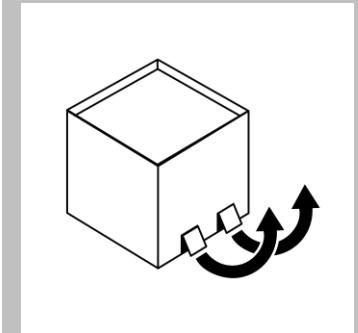
-  Take delivery of boxed appliance. Inspect the appliance for damage before signing the delivery note. Record any damage on the delivery note and notify the carrier and manufacturer.
-  Cut the box banding straps.
-  Remove the lid.
-  Remove the customer documentation and any product accessories. Take note of unpacking instructions.
-  Pull out cardboard flaps.

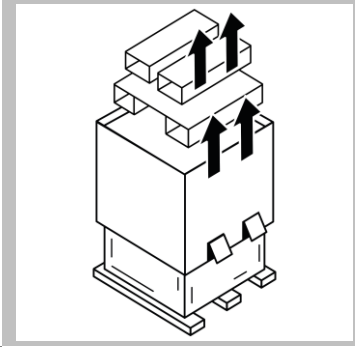
6.  Remove internal packing and outer sleeve.

7.  Remove plastic packaging.

8.  Release plug from carton holder.

 **WARNING**

Never install or put into service a damaged appliance under any circumstances.

5.4 Taking the appliance off the pallet

The weight of your appliance is given in the 'Technical Data' on page 80.

1.

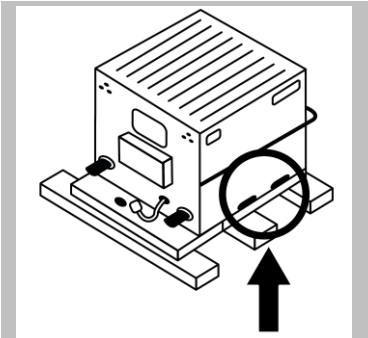

Identify appropriate lifting points.

2.

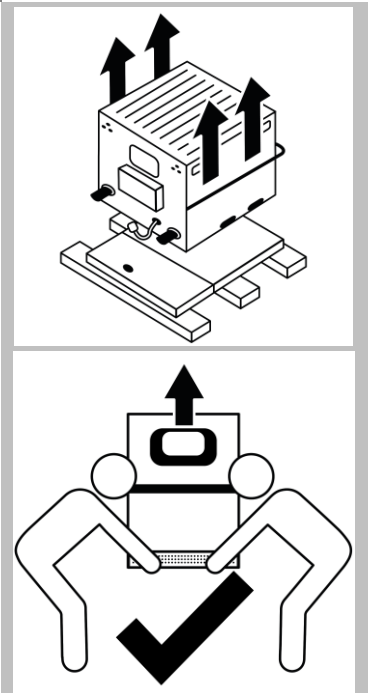

After pushing back the base cardboard at the front of the oven, lift the appliance from packaging. (Ensure 2 people to lift)
Wear appropriate Personal Protective Equipment.

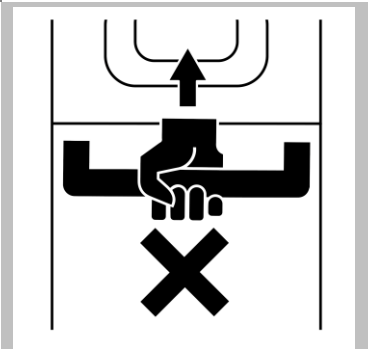

! WARNING

- Don't lift the oven from the handle.
- Risk of crushing from the appliance tipping over.

5.5 Mounting the appliance on a work surface

⚠ Rules for setting up the appliance

Observe the following rules to ensure that the appliance is installed in a stable situation:

- It must be possible to set up the work surface in the installation position so that it cannot tip over or slide about. The supporting surface must comply with the requirements.
- The work top must have a non-slip surface.

■ Merrychef eikon e2s base seal details:

According to Section 5.20.2 of NSF4;

Counter-mounted equipment shall be designed and manufactured to be:

- Portable; or
- Sealed to the counter; or
- Elevated on min. 4" legs that allow easy ingress for cleaning

The Merrychef eikon e2s oven is factory fitted with a self-sealing base-to-counter gasket that meets the requirements for NSF4 counter-mounted equipment.

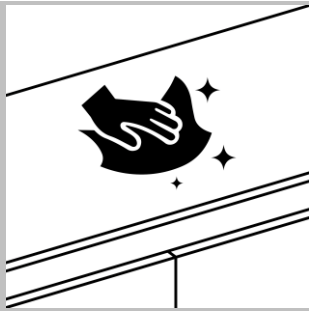
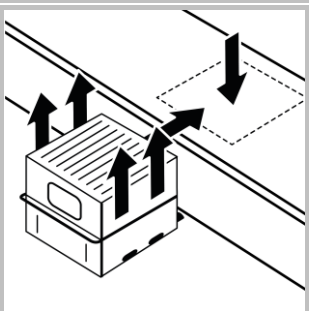
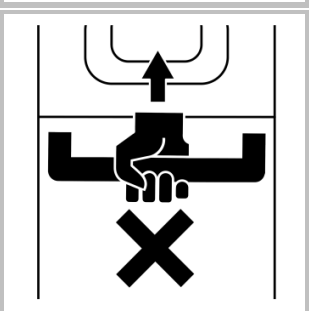
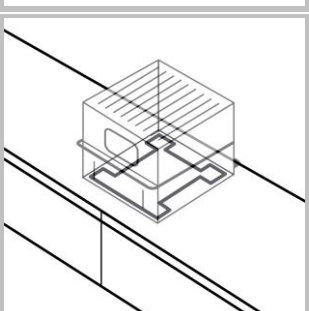
	<p>Prepare a flat and thoroughly CLEAN, dry surface for the oven.</p>
	<p>Unpack the oven following the instructions in section 5.3 and lift the oven onto the prepared surface. (Ensure 2 people to lift).</p>
	<p>⚠ WARNING</p> <ul style="list-style-type: none"> ▪ Don't lift the oven from the handle. ▪ Risk of crushing from the appliance tipping over.
	<p>The base of the e2s is sealed to the counter with a nitrile rubber gasket affixed to the base of the oven with cyanoacrylate adhesive in compliance with sealed counter mounted equipment directive of NSF4. The nitrile gasket is self-sealing to the installation surface, no further adhesive is necessary.</p>

6 Installation

■ Purpose of this chapter

This chapter explains how to connect your microwave combination oven to the electrical supply.

6.1 Safe working during electrical installation

■ Eligibility of personnel for the electrical installation

Only electricians qualified under the terms of EN 50110-1 and from an authorized service company are permitted to perform work on electrical equipment.

■ Regulations for the electrical installation

Observe the following requirement to prevent hazards caused by faulty electrical connections:

- The electrical supply must be connected in accordance with applicable local and national regulations and regulations of the professional associations and of the relevant power supply company

■ Réglementations de l'installation électrique

Respecter les exigences suivantes afin d'éviter les risques engendrés par tout raccordement électrique incorrect :

- L'alimentation électrique doit être raccordée conformément aux règles et réglementations locales et nationales applicables des associations professionnelles et du fournisseur d'électricité concerné.

■ Personal Protective equipment

Wear the personal protective equipment specified in the section '*Personal protective equipment*' on page 18 of the '*For your safety*' chapter for the relevant tasks.

■ Live components

 **DANGER**

Risk of electric shock from live parts

When the appliance is not connected to an equipotential bonding system, there is a risk of electric shock from touching live parts.

- ▶ Make sure that any work on the electrical system is performed solely by a qualified electrician from an authorized service company.
- ▶ Make sure that the electrical connections are intact and connected securely before putting the appliance into use.
- ▶ Before preparing the appliance for use, make sure that the appliance, including all metallic accessories, is connected to an equipotential bonding system.

6.2 Planning the electrical installation

■ Meaning

It is crucial to the safe and reliable operation of the appliance that the electrical system is installed carefully and correctly. All the rules and regulations listed here, and the described procedure, must be strictly followed.

■ ⚠ Rules for safe electrical installation of the appliances

Observe the following rules to prevent hazards caused by faulty electrical connections:

- The electrical supply must be connected in accordance with applicable local regulations of the professional associations and of the relevant power supply company.
- The case of the appliance must be grounded in a suitable manner and connected to an equipotential bonding system (EU).
- If two microwave combination ovens are installed in a stacking trolley, both cases of the appliances and the trolley itself must be grounded in a suitable manner and connected to an equipotential bonding system.
- For microwave combination ovens on a wheeled platform, the length of the mains power lead must accommodate the degree of movement allowed to the appliance by the retaining device on the wheeled platform. When moving the assembly (platform plus appliance), never place the mains power lead under tension.
- All electrical connections must be checked when the appliance is prepared for first-time use to ensure cables are laid correctly and connections are made properly.

■ Equipment provided by customer and electrical installation regulations

The table below shows what equipment must be provided by the customer and what regulations must be observed when connecting the appliance.

Equipment	Regulations
MCB / Fuse	Overcurrent protection and connection of the appliance must comply with local regulations and national installation requirements. If the installation includes more than one appliance, one overcurrent device must be provided for each appliance.
Equipotential bonding	The appliance must be incorporated in an equipotential bonding system (EU). Equipotential bonding: electrical connection that ensures that the frames of electrical equipment and any external conductive components are at an equal (or practically equal) potential.
Residual-current device (RCD) / Ground Fault Circuit Interrupter (GFCI)	The installation regulations require protection by a residual-current device (RCD). Suitable residual-current devices meeting the relevant national regulations must be used. If the installation includes more than one appliance, one residual-current device must be provided for each appliance.
Disconnection device	An easily accessible all-pole disconnection device with a minimum contact separation of 3 mm must be installed close to the appliance. The appliance must be connected via this disconnection device. The disconnection device is used to disconnect the appliance from the electrical supply for cleaning, repair and installation work.

■ Fitted frequency-converter

The appliance is fitted with one frequency converter (FC) and EMC mains input filters.

These devices may result in a leakage current of more than 3.5 mA per FC drive.

Use a suitable RCD for the rated voltage.

■ Properties of the residual-current device

The residual-current device (RCD) must have the following properties:

- Filter for filtering out RF currents
- "Time delayed" trip characteristic for RCD devices with trip threshold of 30mA*: prevents RCD being tripped by charging currents of capacitors and parasitic capacitances when appliance is switched on.
- "Leakage current protection, type SI" trip characteristic for RCD devices with trip threshold of 30mA*: insensitive to nuisance tripping.
- *Local national regulations may require lower trip ratings, such as in North America. In which case these lower trip threshold ratings must be adopted, ensuring the dedicated device has a high immunity to nuisance tripping.

Note. Residual Current Devices (RCDs) are also known by other terms, such as Earth Leakage Circuit Breakers (ELCBs), Safety Switches, Ground Fault Interrupters (GFIs) and Ground Fault Circuit Interrupters (GFCIs). These should not be confused with overcurrent protection.

6.3 Electrical installation requirements

Circuit Breakers (MCB ~ Miniature Circuit Breakers)

For overcurrent protection, a Type 'D' circuit breaker (designed specifically for this type of equipment) must be fitted, as a recommend alternative a higher rated type 'C' type breaker can be used (see below). Establishments with standard (Type 'B') circuit breakers are sensitive to 'surges' which occur on switching on freezers, refrigerators and other catering equipment, including microwave combination ovens. An individual, suitably rated overcurrent circuit breaker should be fitted for each appliance installed, along with a separate dedicated Residual Current Device (Ground Fault Circuit Interrupter).

Model	Recommended Circuit Breaker (per phase)	Alternative Recommended Circuit Breaker (per phase)
eikon e2s standard power	D16	C20
eikon e2s high power 1 phase	D32	C40
eikon e2s high power 3 phase	D16	C20

Residual-current device (RCD)

The installation regulations require protection by a Residual Current Device (Ground Fault Circuit Interrupter). Suitable residual current devices, with a high immunity to nuisance tripping, meeting the relevant national regulations must be used. As long cable runs can be a factor in nuisance tripping, they should be avoided.

If the installation includes more than one appliance, one residual-current (GFCI) device must be provided for each appliance.

Low impedance electrical supply

This commercial combination microwave oven complies with EN 61000-3-11. However, when connecting sensitive equipment to the same supply as the appliance, the user should determine in consultation with the supply authority, if necessary, that a low impedance supply is used.

Electrical supply

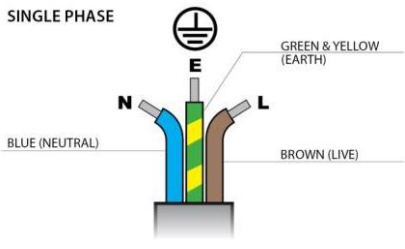
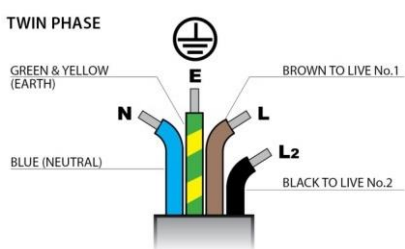
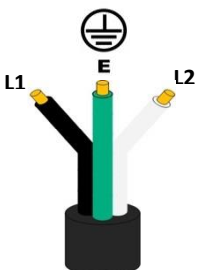
Illustration	Phase	Meaning
	Single phase	<p>UK 13A models are fitted with a moulded plug to BS1363, fused at 13A.</p> <p>EU 16A models are fitted with a moulded plug to CEE 7/7 (Type F Schuko) rated at 16A</p> <p>30A models are fitted with a blue 32A plug to IEC 60309 (EN 60309).</p> <p>Connected to a dedicated RCD (GFCI) protected supply, with appropriate circuit breaker as detailed above.</p>
	Twin phase	<p>Twin phase models should be connected as shown (the twin phase oven requires a three phase supply, utilising L1 & L2 as two separate single phases, L3 is not used).</p> <p>30A models are fitted with a red 32A plug to IEC 60309 (EN 60309).</p> <p>EU 16A models are fitted with a red 16A 90° plug to IEC 60309 (EN 60309).</p> <p>Connected to a dedicated RCD (GFCI) protected supply, with appropriate circuit breaker as detailed above.</p>
	Single phase 60Hz (two pole)	<p>Single phase models, utilising L1 & L2 split phase supply (240V) or L1 & L2 from a three phase supply (208V). Neutral is not used.</p> <p>15A models are fitted with HBL5666C NEMA 6-15P & 15A HBL4570C NEMA L6-15P plugs.</p> <p>20A models are fitted with a HBL5466C NEMA 6-20P plug.</p> <p>30A models are fitted with YP-91L NEMA 6-30P & HBL2621 NEMA L6-30P plugs.</p> <p>Connected to a dedicated RCD (GFCI) protected supply, with appropriate circuit breaker as detailed above.</p>
Please refer to electrical installation data for other country specific models.		

Equipotential bonding



An Equipotential Bonding point is provided on the rear panel of the appliance for independent Earth (GND) connection (not fitted to US models).

Example phase loading diagram

Loading per phase is not equal. Therefore, it is recommended to connect other electrical equipment to a separate L3+N from the mains supply.

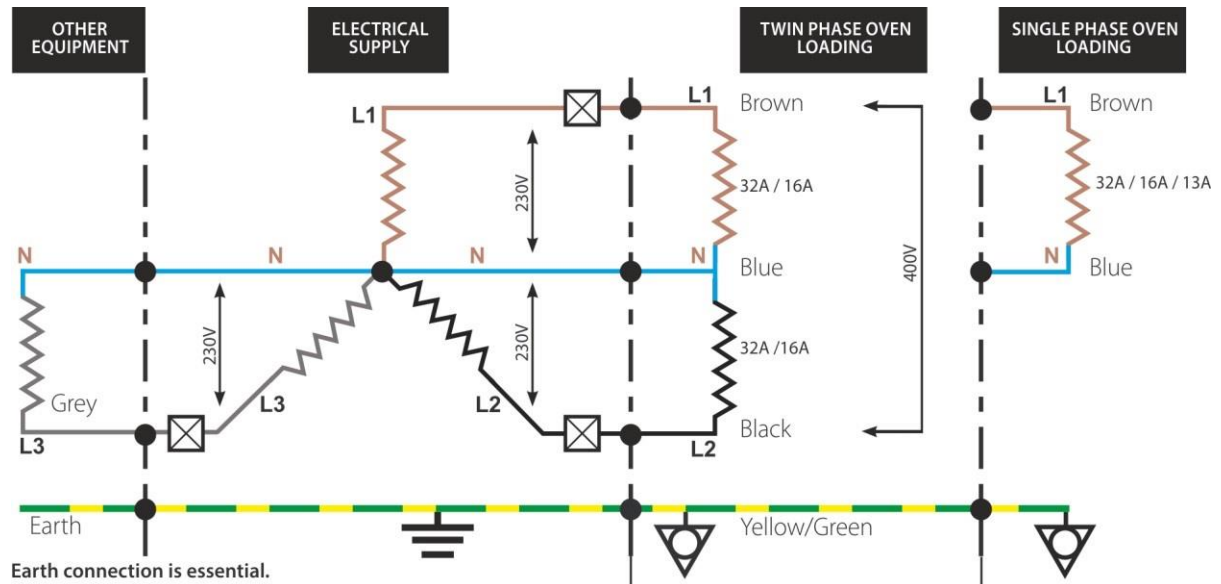

Electrical Ground



Equipotential Bonding



Circuit Breaker

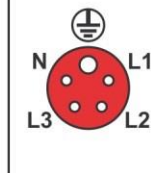

RED
Rear view of plug
Plug Type:
Three Phase 32A
IEC 60309
[EN60309]
L1+L2+N+E
[L3 is not used]

16A 'D'

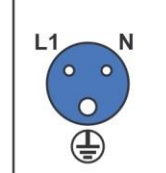

BLUE
Rear view of plug
Plug Type:
Single Phase
32A
IEC 60309
[EN60309]
L1+N+E

16A 'D'

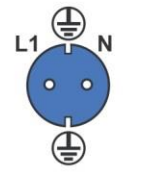

EU plug
16A
CEE 7/7
(Type F
Schuko)

16A 'D'



UK plug
13A fused
BS1363

16A 'D'

208V, Two Pole
L1, L2 & E

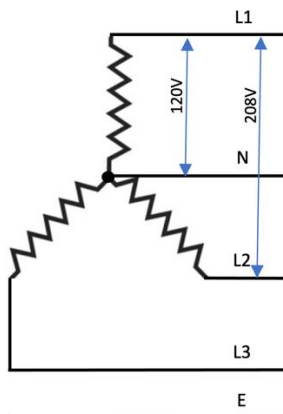

240V, Two Pole
L1, L2 & E

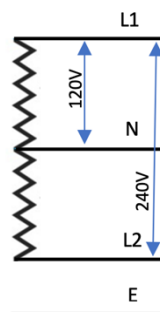

7 Preparing the appliance for use

■ Purpose of this chapter

To show you how to put the microwave combination oven into operation and how to cook.

7.1 Safe working when preparing the appliance for use

■ Personal protective equipment for preparing the appliance for use

Wear the personal protective equipment specified in the section '*Personal protective equipment*' on page 18 of the '*For your safety*' chapter for the relevant tasks.

■ Rules for safe operation of the appliance

To avoid hazards, the following rules must be observed during operation:

- The exhaust vent on the rear of the appliance, and the ventilation holes in the front of the appliance base must not be covered, obstructed or blocked.
- Ensure all appropriate accessories are fitted.

To avoid hazards, the following rules must be observed when operating appliances positioned on a wheeled supporting structure:

- The parking brakes on the front wheels must always be engaged when operating the appliances.
- Check that the wheel brakes are on before operation each day.

■ Live components

DANGER

Risk of electric shock from live parts

When the appliance is not connected to an equipotential bonding system, there is a risk of electric shock from touching live parts.

- ▶ Make sure that any work on the electrical system is performed solely by a qualified electrician from an authorized service company.
- ▶ Before preparing the appliance for use, make sure that the appliance, including all metallic accessories, is connected to an equipotential bonding system.

■ Hot surfaces

WARNING

Risk of burns from high temperatures inside the cavity and on the inside of the appliance door

- ▶ You may get burnt if you touch any of the interior parts of the cooking chamber, the inside of the appliance door or any parts that were inside the oven during cooking.
- ▶ Wear personal protective equipment.

■ Hot steam / vapour

WARNING

Risk of scalding from hot steam and vapour

- ▶ When opening the door, always be cautious of escaping hot steam and vapour which can cause scalding to face, hands, feet and legs.
- ▶ When you are cooling the cavity using the 'cool down' function, step back from the appliance to avoid the hot steam and vapour escaping through the open door.

■ Excessive microwave energy

WARNING

Risk of burns from excessive microwave energy

PRECAUTIONS TO AVOID POSSIBLE EXPOSURE TO EXCESSIVE MICROWAVE ENERGY

- ▶ Do not attempt to operate this oven with the door open since open-door operation can result in harmful exposure to microwave energy. It is important not to defeat or tamper with the safety interlocks.
- ▶ Do not place any object between the oven front face and the appliance door or allow soil or cleaner residue to accumulate on sealing surfaces.
- ▶ Do not operate the oven if it is damaged. It is particularly important that the oven door closes properly and that there is no damage to the (1) door (bent), (2) hinges, (3) door seals and sealing surfaces.
- ▶ The oven should not be adjusted or repaired by anyone except properly qualified service personnel.

■ Radio interference

NOTICE

This is a Class A product. In a domestic environment this product may cause radio interference in which case the user may be required to take adequate measures.

Reduce or eliminate interference to radio, television, or other electrical appliances by doing the following:

- Place electrical appliances as far away from the microwave combination oven as possible.
- Use a properly installed antenna on radio, television, etc. to obtain stronger signal reception.

■ Interférence radio

AVIS

Produit de classe A. Dans un environnement domestique, ce produit peut occasionner des interférences radio imposant à l'utilisateur de prendre des mesures adéquates.

Réduire ou éliminer les interférences vers la radio, la télévision ou tout autre appareil électrique en effectuant ce qui suit :

- Placer les appareils électriques aussi loin que possible du four combiné à micro-ondes.
- Utiliser une antenne, correctement installée, sur la radio, la télévision, etc. pour obtenir une meilleure réception du signal.

7.2 Procedure for preparing the appliance for use

Checks prior to preparing the appliance for use

Before preparing the microwave combination oven for use, use the checklists below to make sure that all important requirements are met. The appliance must not be put into operation until all the specified requirements are met.

Checklist for moving, setting up and installing the appliance:

- Cardboard packaging and transport securing devices etc. have been removed completely from the appliance.
- The appliance has no signs of damage.
- The appliance has been set up so that it cannot slide about or tip over; the requirements for the installation position and the area around the appliance have been met.
- The appliance is installed in accordance with the installation regulations.

Checklist for safety devices and warnings:

- All safety devices are in their designated position, are working correctly and are secured properly in place.
- All warning signs are in their designated position.

Suitable cooking utensils

Check the manufacturer's instructions and temperature rating to determine the suitability of individual containers or utensils using each of the cooking functions. The following chart provides general guidelines:

Cooking utensils	Permitted	Notice
Heat resistant containers		
Toughened glass	YES	
Compatible vitreous ceramics	YES	Do not use items with metallic decoration.
Earthenware (porcelain, crockery, china, etc.)	YES	
Metallic and foil trays		
Any metal or foil containers	NO	
Plastic containers		
Dual-oven able plastic containers	YES	Use only plastic containers approved by the manufacturer.
Disposables		
Combustibles (paper, card, etc.)	YES	Use only combustibles approved by the manufacturer.
Other utensils		
Tie tags	NO	
Cutlery	NO	No kitchen utensil should be left in a food product while it is cooking in the cavity.
Temperature probes	NO	

■ Ustensiles de cuisine appropriés

Vérifier les instructions du fabricant et les caractéristiques thermiques afin de déterminer la compatibilité de différents récipients ou ustensiles avec les différentes fonctions de cuisson. Le graphique suivant fournit des directives générales :

Ustensiles de cuisson	Autorisé	Avis
Récipients résistant à la chaleur		
Verre trempé	OUI	
Vitrocéramique compatible	OUI	Ne pas utiliser d'articles avec décoration métallique.
Poterie (porcelaine, vaisselle, etc.)	OUI	
Bac métallique et à film		
Tout récipient métallique ou à film	NON	
Contenants de plastique		
Récipients plastiques bi-four	OUI	Utiliser uniquement des récipients plastiques approuvés par le fabricant.
Articles jetables		
Combustibles (papier, carton, etc.)	OUI	Utiliser uniquement des combustibles approuvés par le fabricant.
Autres ustensiles		
Étiquettes autocollantes	NON	
Coutellerie	NON	Aucun ustensile de cuisine ne doit rester dans une denrée alimentaire pendant la cuisson dans l'espace intérieur.
Sondes de température	NON	



■ Start up

- 

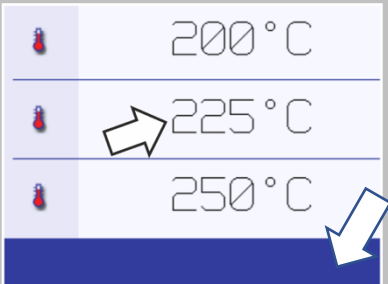
Make all the relevant safety checks and ensure the appliance is clean and empty.
Then switch the appliance ON.
- 

The easyTouch® screen illuminates with the display briefly showing the serial number and appliance data and connectivity (KCCM) if fitted.
If required, to keep the data on the screen, lightly tap the screen in the centre once, to freeze the display. Tap again to continue.
If only one preheat temperature has been pre-set, the oven will then automatically start heating up to temperature.
- 

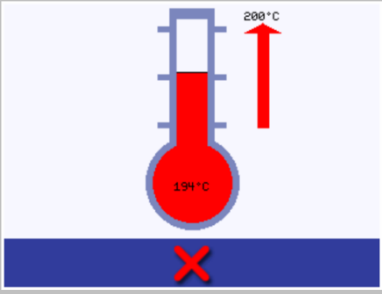
When the appliance is set up with two or more preheating temperatures a choice is displayed.
A scroll arrows at the bottom of the screen indicate that there are more temperature choices not shown on the screen.
If necessary, use the scroll arrow in the bottom right of the screen to view the other temperature options, or to return to the previous selection. Then select the temperature required to start preheating the cavity.

4.  During preheating the display shows the progress as the cavity heats up to the set temperature.
To stop the cavity heating up touch the red 'X' symbol at the bottom of the screen.
5.  In Quick Service Mode the appliance is ready to use when the 'cookbook' is displayed.
In Full Serve Mode the main menu screen ("chefs' hat screen") is displayed.

Customer guidance and instruction

Instruct the user regarding all safety-related functions and devices.





Instruct the user in how to operate the appliance.

7.3 Main menu screen

Appearance



The buttons and what they do

Button	Meaning	Function
	Development Mode or Manual Cooking Mode	'Development Mode' enables multistage cooking profiles to be developed, then stored under a name and symbol for reuse. 'Manual Mode' enables multistage cooking without the need for a pre-programmed cooking profile.
	Press&Go	'Press&Go' allows quick access to use the cooking profiles that are already stored.
	Cookbook	'Cookbook' contains the cooking profiles stored in the memory of the appliance. It displays favourites, cooking profile groups and a complete listing of all cooking profiles available.
	Cleaning / Temp change	'Cleaning / Temp change' allows the cavity temperature to be changed and the appliance to be prepared for cleaning with reminders displayed to assist during the cleaning process.
	Settings	'Settings' are used to control the appliance settings and functions including time and language, loading cooking profiles and for service and maintenance purposes.

■ The easyTouch screen display









The easyTouch® screen display, layout and icons shown herein are for guidance purposes only and are not intended to be an exact representation of those supplied with the appliance.

7.4 The keyboard screen

■ Appearance



■ The buttons and their functions

Button	Meaning	Function
	Keyboard screen	The keyboard screen is used to enter an authorised password to enter data for programmes and may restrict operator access to some functions.
	Clear screen	Select the 'clear screen' key to delete all text from the keyboard screen.
	Keyboard	Type in text using the keyboard.
	Spacebar	Select the 'spacebar' key to insert a blank.
	Return	Select the 'return' key to start a new line.
	Keyboard scroll	Select the up/down arrows to scroll the keyboard screen, for lowercase, numbers, etc..
	Enter / OK	Select the green check mark to confirm settings and continue.
	Previous screen	Select the 'backspace' key to return to a previous screen.

■ Character length

- For names of cooking profiles, names of cooking profile groups and passwords use 1-20 characters in 2 lines max.
- For stage instructions of individual cooking profiles use 1-54 characters in 5 lines max.

8 Cooking procedures

Purpose of this chapter

This chapter shows you how to operate the microwave combination oven for cooking and what procedures to follow for cooking.

8.1 Operating principles and instructions for cooking

8.1.1 Working safely with the appliance

Your safety and the safety of your staff

Before your personnel start working with the microwave combination oven for the first time, familiarize yourself with the information contained in the chapter '*For your safety*' on page 12 and make relevant safety arrangements.

Instruct your personnel to learn the safe-working rules given in this section before starting work, and to follow them strictly.

Instruct your personnel to familiarize themselves with the hazard warnings listed in this section and in further instructions below and instil in them the importance of taking the specified precautions.

Personal protective equipment for your personnel

Instruct your personnel to wear the correct personal protective equipment specified in the section '*Personal protective equipment*' on page 18 of the '*For your safety*' chapter for the relevant tasks.

Rules for safe operation

To avoid hazards, the following rules must be observed during operation:

- The air outlets on the rear of the appliance, and the air inlets on the front of the appliance underneath the door must not be covered, obstructed or blocked.

Additional rules for safe operation on a wheeled trolley

To avoid hazards, the following rules must be observed when operating appliances positioned on a wheeled trolley:

- The parking brakes on the front wheels must always be engaged when operating the appliances.
- Check that the wheel brakes are on before operation each day.

Handling heavy loads

Inform your personnel that lifting heavy containers and moving heavy transport trolleys may result in tiredness and discomfort, and faults may occur with the moving equipment.

Hot surfaces

WARNING

Risk of burns from high temperatures inside the cavity and on the inside of the appliance door

You may get burnt if you touch any of the interior parts of the cavity, the inside of the appliance door or any parts that are or were inside the oven during cooking. Wear personal protective equipment.

■ Hot steam / vapour

WARNING

Risk of scalding from hot steam and vapour

Escaping hot steam and vapour can cause scalding to face and hands.

- ▶ When opening the door and when cooling the cavity using the 'Cool Down' function, step back from the appliance to avoid the hot steam and vapour hit your body after escaping through the open door.

■ Hot liquids

WARNING

Risk of scalding from hot liquids

Spilling liquid foods can result in scalds to face and hands.

- ▶ Only use containers of appropriate size.
- ▶ Insert the food containers correctly.
- ▶ Always place containers holding liquids or holding food that will liquefy during cooking on shelves that allow a proper view into the container for all users. Always take out horizontally any containers holding liquids or holding food that will liquefy during cooking.
- ▶ Wear personal protective equipment.

■ Excessive microwave energy

WARNING

Risk of burns from excessive microwave energy

PRECAUTIONS TO AVOID POSSIBLE EXPOSURE TO EXCESSIVE MICROWAVE ENERGY

- ▶ Do not attempt to operate this oven with the door open since open-door operation can result in harmful exposure to microwave energy. It is important not to defeat or tamper with the safety interlocks.
- ▶ Do not place any object between the oven front face and the appliance door or allow soil or cleaner residue to accumulate on sealing surfaces.
- ▶ Do not operate the oven if it is damaged. It is particularly important that the oven door closes properly and that there is no damage to the (1) door (bent), (2) hinges, (3) door seals and sealing surfaces.
- ▶ The oven should not be adjusted or repaired by anyone except properly qualified service personnel.

■ Break in the cold chain

WARNING

Risk of microbiological contamination of foods



- ▶ Never use the appliance for temporary storage of food.
- ▶ Never intentionally interrupt the cooking process.
- ▶ Once the appliance is running again after a power failure, consider how the length of time taken to resume operation will affect the food condition. If in doubt discard the food.

8.1.2 Turning the oven on and off

■ For your safety when using the microwave combination oven



Before starting work, it is essential that you familiarize yourself with the rules and hazard warnings specified in '*Working safely with the appliance*' on page 38, and follow the instructions given there.

■ Switching on the microwave combination oven

1.  Switch on the microwave combination oven.
2.  Wait until the software is ready for use.

NOTE:
The main menu screen visible on the left is only displayed in Full Serve Mode.

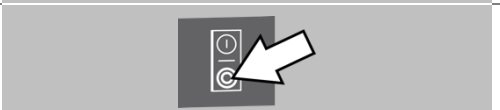
■ Switching off the microwave combination oven at the end of the day

1.  Perform the necessary cleaning tasks as specified in the cleaning schedule.
2.  Switch off the microwave combination oven.
3.  Leave the appliance door ajar in order to let moisture escape.

NOTE:
Switch off the mains power on site before prolonged breaks in use.

8.1.3 How to cook

-  **For your safety when using the microwave combination oven**
Before starting work, it is essential that you familiarize yourself with the rules and hazard warnings specified in '*Working safely with the appliance*' on page 38, and follow the instructions given there.

■ Requirements

- You are sufficiently familiar with using the software to be able to select saved cooking profiles or enter new cooking profiles that are suitable for the food you wish to cook, and to run these profiles.
- The microwave combination oven and accessories and fittings used have been cleaned properly.
- There are no foreign objects in the cavity.
- The air filter is fitted in place on the oven front underneath the appliance door.

How to cook

1. Select a cooking profile from the cookbook or enter a new cooking profile.
2. Follow the prompts displayed by the software.
3. Open the appliance door.
4. Place the prepared food in the microwave combination oven.
5. Close the appliance door again.
6. Start the cooking process.
7. Wait for the cooking process to finish.
8. An audible signal is given when the cooking process is finished.
Follow the prompts displayed by the software.
9. Open the appliance door.
10. Take out the food.
11. Close the appliance door again.

Using a cooking profile (Quick serve Mode)

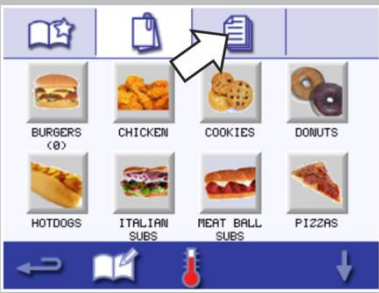
1.  Select the 'all menus' symbol.



BURGERS (0)	CHICKEN	COOKIES	DONUTS
HOTDOGS	ITALIAN SUBS	MEAT BALL SUBS	PIZZAS
2.  Use scroll up/down arrows to find the cooking profile.

NOTE:
If a picture has a red frame around it the cavity temperature is set too high or too low for that cooking profile.
See '*Changing the cavity temperature*' on page 48.
Ensure that a food product is placed into the cavity before starting a cooking profile.
Take all the necessary precautions to ensure that you do not burn yourself.
Open the appliance door, place the food product into the hot cavity and close the door.

SWEET ROLL	SCHNITZEL PANIERT	SCHNITZEL PANIERT2	PIG ROAST
SEMMEL	PORK CHOPS1	PORK CHOPS2	SAPAGUS
3.  Select the required cooking profile to start cooking.
Example: 'ITALIAN SUB x 1'.

! WARNING:
Hot surfaces at the door and in the cavity

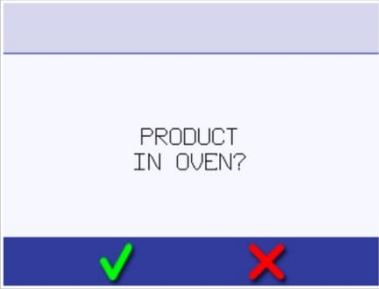

12 DONUT	1 HOTDOG	2 HOTDOGS	3 HOTDOGS
4 HOTDOGS	ITALIAN SUB X 1	ITALIAN SUB X 2	ITALIAN SUB X 3

4.  The cooking profile either starts immediately displaying a countdown timer, or an instruction is displayed first. Follow the stage instruction and then press the green check mark to start the cooking profile.
5.  The cooking timer counts down to zero and makes a sound to indicate that an operator action is required at the end of a cooking profile or of a stage of a cooking profile. Open the door after the cooking profile has finished and remove the food product from the cavity. The display then returns to the 'cookbook' screen automatically.
- NOTE:**
- Opening the door during cooking stops the cooking profile and a warning appears.
 - Closing the door allows the user to continue or cancel the cooking profile.

8.2 Operation instruction: Full serve mode

8.2.1 The Press&Go menu

Running a cooking profile from the Press&Go menu

1.  Select 'Press&Go' from the main menu screen.
2.  Select the cooking profile required to cook.
3.  The display shows the cooking time count down. The timer bar turns red to indicate that the cooking cycle has finished.

■ Choosing which cooking profiles are shown in the Press&Go menu screen

1. 

After selecting 'Press&Go' from the main menu screen, select the 'edit cookbook' symbol.

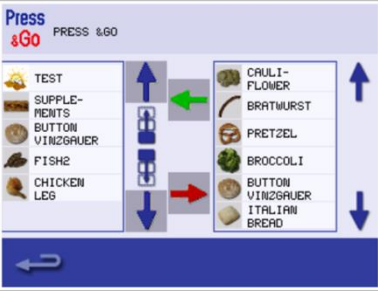
2. 

Two lists are displayed.
The list on the left shows the cooking profiles being part of the 'Press&Go' menu.
The list on the right shows other cooking profiles which are available.
Both lists can be scrolled up or down using the blue arrows on the right of each list.

3. 

Select a cooking profile from the list on the left.
Choose whether to change its position within the list or to remove it into the list on the right.
To change the order of cooking profiles in the left list use the blue up/down arrows in the middle.
To move a selected cooking profile to, or from, the 'Press&Go' menu use the green/red arrows in the middle.

4. 

To make a cooking profile from the right list available in the 'Press&Go' menu move it into the left list.

5. 

Select backspace to return to the 'Press&Go' menu screen when finished.

8.2.2 Using a cooking profile

■ Using a cooking profile

1. 

Select the 'cookbook' symbol from the main menu screen.

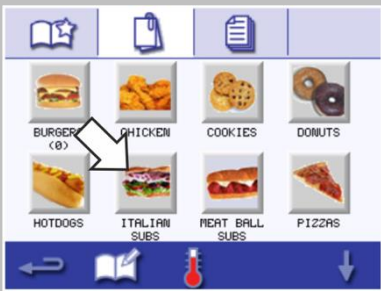
2. 

Select a group of cooking profiles, for example 'ITALIAN SUBS', to display the individual cooking profiles.

3. 

Select a cooking profile to start, for example 'ITALIAN SUB x 2'.

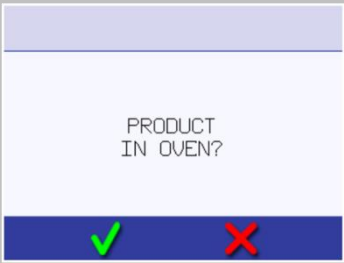
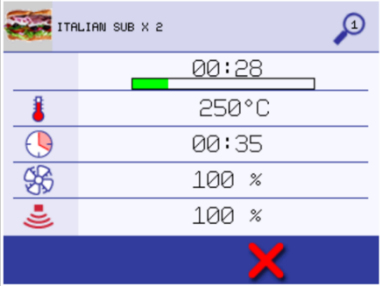
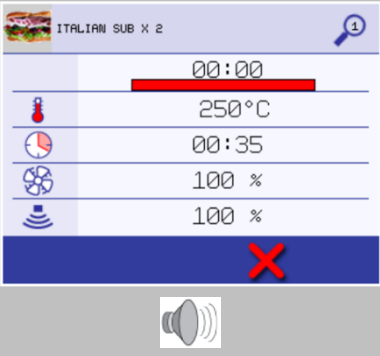
4.  Follow any instructions on the screen, if displayed.
Press the green check mark to cook.
5.  The cooking time counts down for each program stage.
To check the cavity temperature when cooking, lightly tap the temperature displayed. The cavity temperature is shown with an asterisk.
6.  When the cooking profile ends a red bar is displayed usually with an audible sound. Open the door or touch the red 'X' to return to the cooking profile.
Opening the appliance door during cooking stops the cooking profile and displays a warning.
Closing the door allows the user to continue or cancel the cooking profile.

8.2.3 Creating a cooking profile

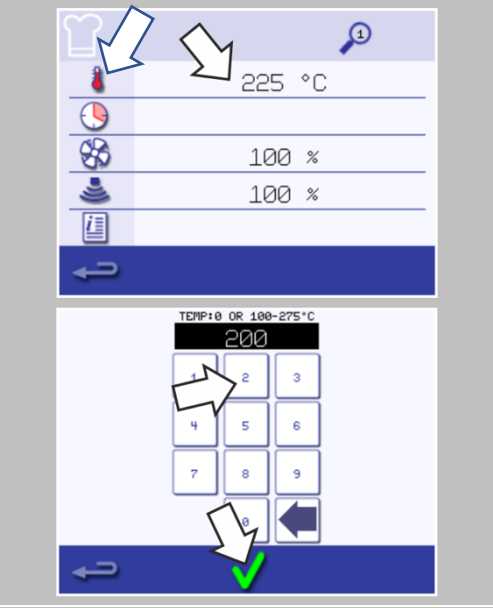

Creating a cooking profile

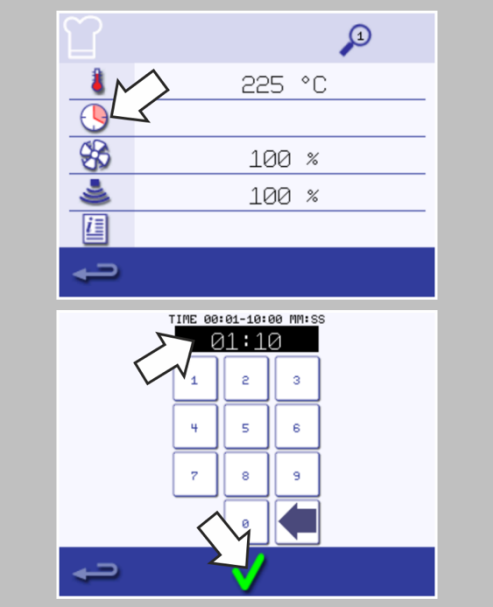
1.  Select the 'chef's hat' symbol from the main menu screen to enter the Development Mode. Note: the oven must not be set in Manual Mode.
2.  The temperature value displays the set temperature for preheating the cavity.
To increase or decrease the temperature required, select the 'temperature' symbol.

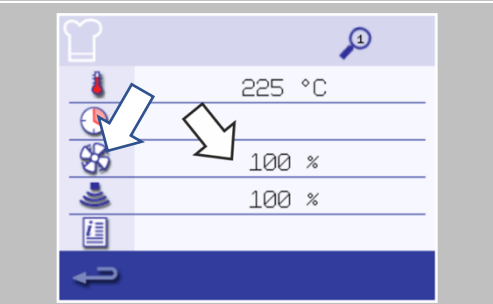
Enter a temperature value in the keypad within the limits displayed.
Select the green check mark to continue.
3.  Select the 'clock' symbol.

Enter the cooking time in the keypad up to a maximum of 10 minutes for each stage.
Example: Enter 110 (for 1 minute and 10 seconds).
Select the green check mark to save the inserted value.
4.  Select the 'fan' symbol to set the fan speed within the limits shown on the screen.

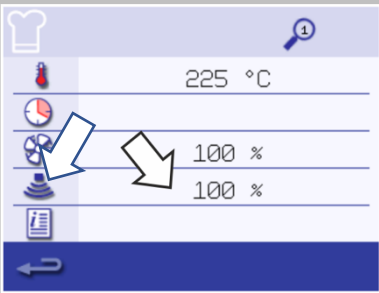
Set the fan speed in the keypad (10-100%)
Select the green check mark to save the inserted value.

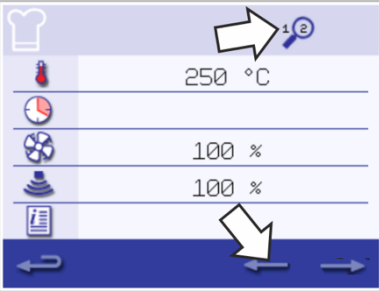
5.  Select the 'microwave' symbol.
- Set the microwave power in the keypad (0 and 5-100%).
Select the green check mark to save the inserted value.
6.  Select the 'information' symbol to enter an instruction of a stage (optional).
- Example: "Stage 1 - place a food product into the cavity".*
- When cooking the instruction appears in the display at the beginning of that stage.
Select the green check mark to save the inserted instruction.
-  Select the right arrow with a 'plus' symbol at the bottom to add a new stage.
- Delete a stage by pressing the 'dustbin' symbol.
7.  Cooking profiles can have up to a maximum of 6 stages.
- Repeat the steps 2-6 from stage 1 above to create a new stage.
- The 'magnifier' symbol at the top indicates which stage is displayed on the screen.
- Select the left/right arrow displayed at the bottom to shift between the set stages.

Running and saving a cooking profile

1. 

Press the green check mark to confirm the cooking profile.

⚠ WARNING:
Ensure that a food product is in the cavity and that all safety precautions are followed before running the cooking profile.
2. 

Select the 'start' symbol to run the cooking profile (optional).
If the results are not satisfactory, select the backspace symbol, change the cooking settings and retest.
3. 

Select the 'save cookbook' symbol to record the cooking profile to the cookbook.
4. 

Select the 'camera' symbol to open pictures.
5. 

Select a picture to represent the new cooking profile.
Use the scroll arrows for displaying more pictures.
6. 

Enter a name for the cooking profile, using a maximum of 20 characters, for example, '1 PIZZA'.
Press the green check mark to save the cooking profile to the cookbook.

A green check mark on a 'cookbook' symbol indicates that the cooking profile has been saved to the cookbook.

8.2.4 Using a cooking profile

Changing the cavity temperature

1.



Take note of the cavity temperature required for the cooking profile.
Then press the green tick to continue.

2.



Select the 'temperature' symbol.

3.

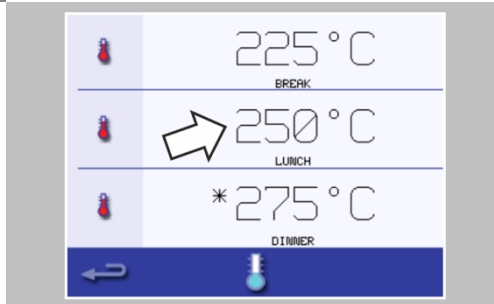

An asterisk next to the temperature value indicates the present cavity temperature.

Select the required cavity temperature for the cooking profile, for example 250°C / 482°F.

Once the cavity reaches the required temperature continue from selecting the 'cookbook' in step 1.

■ Viewing and editing cooking profiles

1.  Select the 'cookbook' symbol from the main menu screen.
2.  Select the 'all menus' symbol.
3.  Select the 'edit cookbook' symbol.
4.  Use the up/down scroll arrows on the right side of the screen to find the cooking profile, for example 'ITALIAN SUB x 1'.
Select the 'view/edit cooking profile' symbol.
5.  View or adjust the cooking profile as required.
See 'Development Mode' for details.

■ Move a cooking profile in a group of cooking profiles

Example: Moving the position of the 'ITALIAN SUBS x 4' cooking profile within the group of cooking profiles called 'ITALIAN SUBS'.

1.  Select the 'cookbook' symbol from the main menu screen.

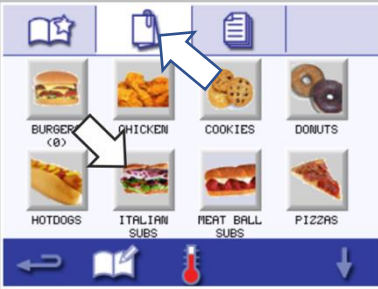
2.  Select the 'ITALIAN SUBS' group of cooking profiles.



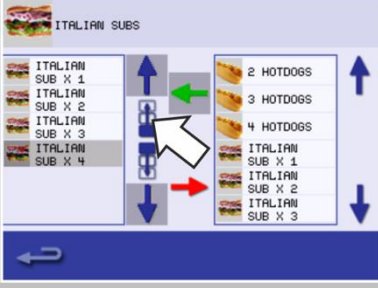

3.  Select the 'edit cookbook' symbol.

4.  Two lists are displayed.
The list on the left shows the cooking profiles within the 'ITALIAN SUBS' profile.
The list on the right show other cooking profiles which are available.
The large up/down arrows to the side of the lists allows for scrolling up and down.
Select the cooking profile to be moved, for example 'ITALIAN SUB x 4'.
Use the blue up/down arrows in the middle to move the selected cooking profile within the group of cooking profiles.

5.  Press the backspace button to return to the 'cookbook' screen.

■ Add a cooking profile in a group of cooking profiles

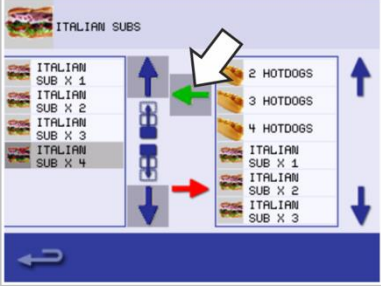
Example: Add a cooking profile 'ITALIAN SUB x 4' to the group of cooking profiles 'ITALIAN SUBS'.

1.  Select 'cookbook' from the main menu screen.
2.  Select the group of cooking profiles 'ITALIAN SUBS'.
3.  Select the 'edit cookbook' symbol.
4.  Two lists are displayed.
The list on the left shows the cooking profiles within the 'ITALIAN SUBS' profile.
The list on the right show other cooking profiles which are available.
The large up/down arrows to the side of the lists allows for scrolling up and down.
Use the up/down scroll arrows on the right side on the right part of the screen to find and select the 'ITALIAN SUB x 4' cooking profile.
5.  Select the green 'left' arrow to add the 'ITALIAN SUB x 4' cooking profile to the group of cooking profiles in the left part of the screen. Then select backspace to return to the cooking profiles.
6.  Select backspace to go back to the 'cookbook'.

8.2.5 Managing cooking profile groups

Move a cooking profile group in a list

1.  Select the 'cookbook' symbol from the main menu screen.

2.  Select the 'edit cookbook' symbol.

3.  Use the big scroll arrows to locate all cooking profile groups.

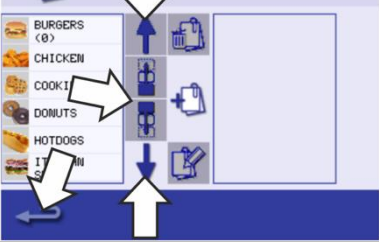
4.  Select the group of cooking profiles to be moved.
Use the small up and down arrows in the centre of the screen to move the selected cooking profile within the list.

5.  Select the backspace button to return to the 'cookbook'.

■ Adding a new cooking profile group

1. 

Select 'cookbook' from the main menu screen.

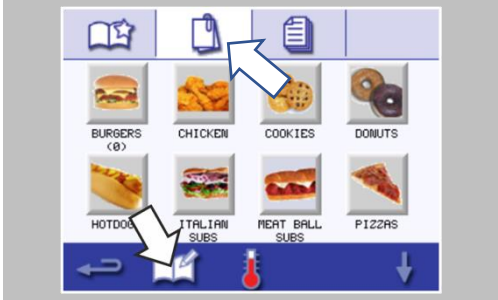
2. 

Select the 'edit cookbook' symbol.

3. 

Select the 'add a new cooking profile group' symbol.

4. 

Select the 'camera' symbol to open a pictures database.

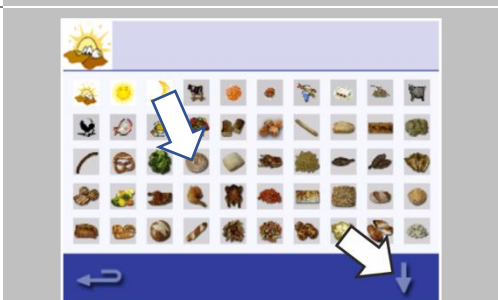
5. 

Select a picture from the database to represent the cooking profile group.
Use the scroll arrows at the bottom of the screen for more pictures.



6. 

Enter a name for the new cooking profile group (max. 20 characters).
Press the green check mark to save the cooking profile group to the cookbook.

7. 

Select the backspace button to go back to the 'cookbook'.

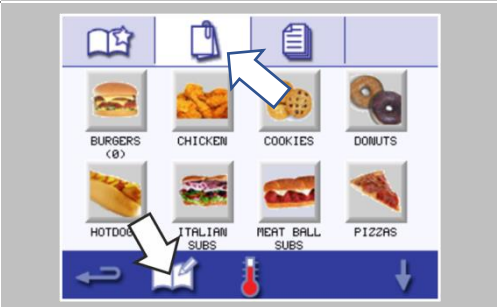
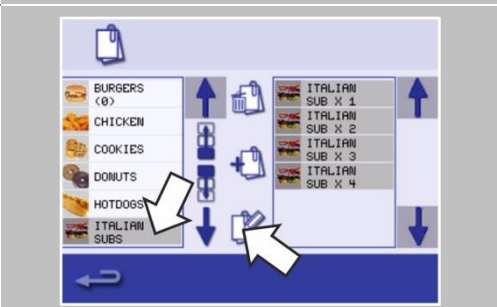
■ Edit a selected cooking profile group name

1.  Select the 'cookbook' symbol from the main menu screen.
2.  Select the 'edit cookbook' symbol.
3.  Select the cooking profile group and the select the 'edit cooking profile group' symbol.
4.  Enter the new name of the cooking profile group.
Select the green check mark to continue.
5.  Select the backspace button to go back to the 'cookbook'.

■ Deleting a cooking profile group

1.  Select the 'cookbook' symbol from the main menu screen.

2.  Select the 'edit cookbook' symbol.

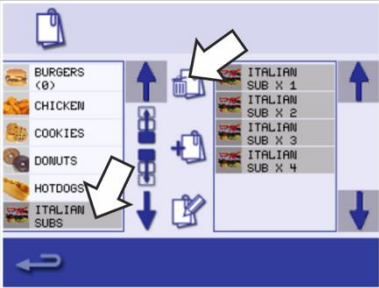
3.  Select the cooking profile group you want to remove from the cookbook.
Select the 'delete cooking profile group' symbol.

4.  Select the green check mark to delete the cooking profile group.



NOTE:

Deleting a cooking profile group from the cookbook does not delete the cooking programs from the 'all menus list'.

5.  Select the backspace button to go back to the 'cookbook'.

8.2.6 Basic settings of your microwave combination oven

Control settings and icons

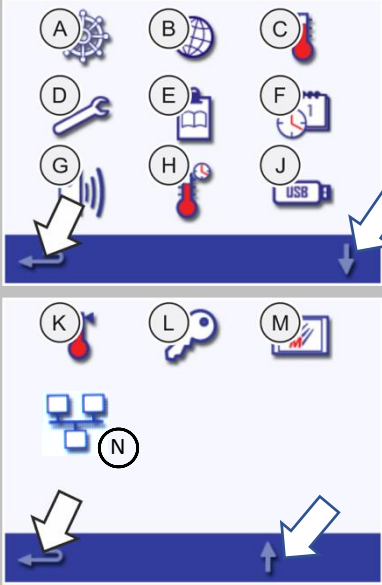
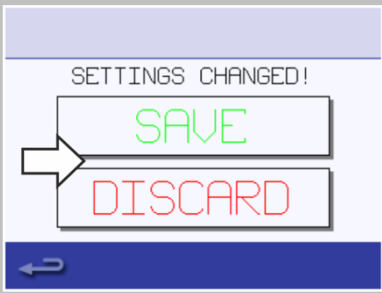
1.  Select the 'settings' symbol from the main menu screen.
2.  Enter the password 'MANAGER'.
Select the green check mark to display the 'settings' menu.
3.  The 'settings' menu comprises the following functions:
A. Operating mode / navigation settings
B. Language options
C. Pre-Heat Temperature settings and labels
D. Service information and error logs (password required)
E. Cooking profile counters
F. Date and time settings
G. Speaker settings and sound levels
H. Timer (Temperature / ON / OFF)
J. USB program connection
K. Temperature band ("Temp Band")
L. Change access passwords, settings and service screens
M. Screen saver
N. Kitchen Connect
When finished with a setting, select backspace to return to the main settings menu.
Use the up/down scroll arrows at the bottom of the screen to display all functions of the 'settings' menu.
4.  Press the backspace button to exit the 'settings' menu.
A prompt appears to either 'SAVE' or 'DISCARD' any changed settings. Discard will not save any changes made.

■ Operating mode/navigation settings

1. 

Select the 'operating mode / navigation' symbol from the 'settings' menu.
2. 

Select 'QUICK SERVE MODE' for cooking only.

Select 'ENABLE SETTINGS' to display an 'unlock' symbol on the 'Quick Serve Mode' screen to allow access to the 'settings' menu.

Select 'FULL SERVE MODE' to display the main menu screen. The 'chef's hat' is then used for creating cooking profiles.

Select 'MANUAL MODE' to manually cook only via the 'chef's hat' symbol on the main menu screen, cooking profiles cannot be created in manual mode.

Select 'SHOW FAVORITES' to display the favourites icon at the top of the cookbook screens.

Select 'SHOW ALL RECIPES' to display the 'all recipes' icon at the top of the cookbook screens.

Use the up/down scroll arrows at the bottom of the screen to display all functions of the 'operating mode / navigation' menu.
3. 

Select 'MAGNETRON ENERGY DELAY' to enable a magnetron warm up period for all cooking profiles.

Select 'ENERGY SAVING' to enable the hibernation mode when the oven is inactive.

NOTE:

If a green check mark is displayed the corresponding function is active.
4. 

When finished, select backspace to return to the main settings menu.

Language options

- 

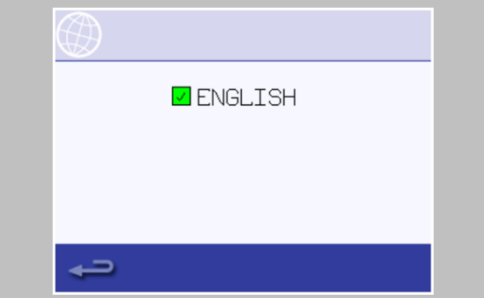
Select the 'globe' symbol.
- 

Select the checkbox(es) of the required language(s) from the list shown.

Note: the number of languages available for selection is determined by the menu file (.cbr) loaded on to the oven
- 

When finished, select backspace to return to the main settings menu.

Cavity temperature settings and labels

- 

Select the 'temperature' symbol.

Up to six pre-heat temperatures can be set.

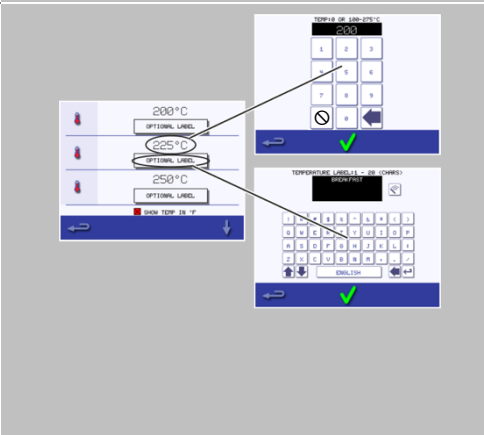
Note: The temperature options screen is only displayed at start up when two or more cavity temperatures are set above minimum.
- 

Select a 'temperature' symbol to add or change the cavity preheat temperature.

Enter the required temperature on the appearing keypad and select OK.

Zero '0' can be selected for a microwave only selection.

Selecting  removes the temperature selection from the pre-heat options.

To change or set a temperature label to be displayed under a pre-heat temperature option, select the label.

Enter the required label name on the appearing keypad and select OK.
- 

When finished, select backspace to return to the main settings menu.

Service information and error logs

For service information and error logs refer to '*Rectifying faults*' on page 84.

Cooking profile counters

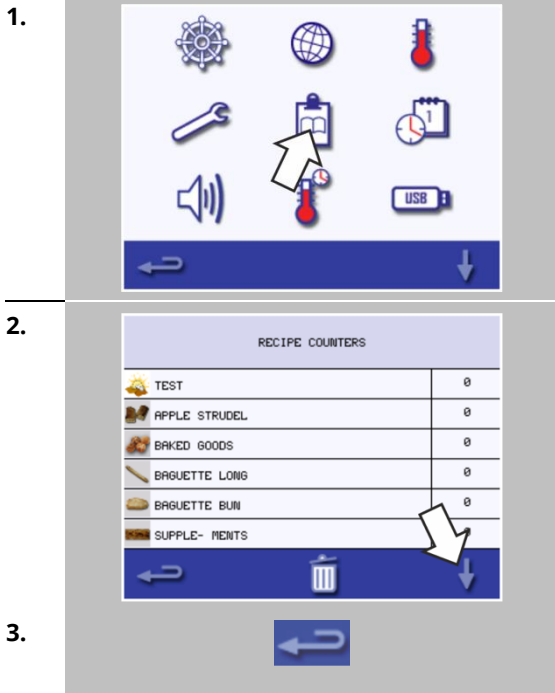

1. Select the 'clipboard' symbol to display a listing of cooking profile counters.

2. If the list of cooking profile counters is shown, use the up/down arrows at the bottom of the screen to scroll it.

The recipe count can be copied on to USB key, from the main menu screen, if required.

Recipe counts can be put back to zero by selecting the individual recipe followed by the trash can.

3. When finished, select backspace to return to the main settings menu.

Date and time settings

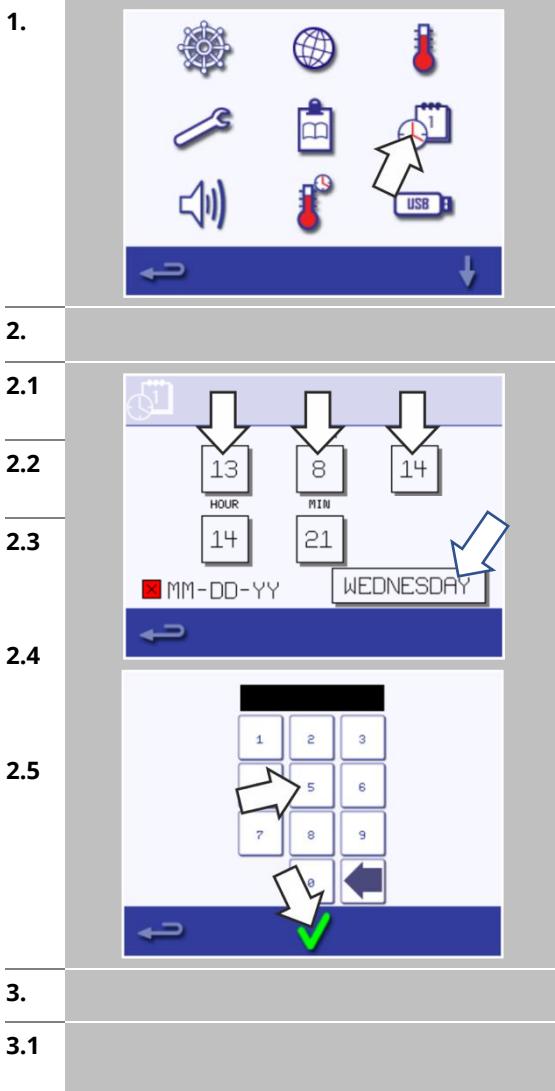

1. Select the 'clock/date' symbol to display the setting options.

To change the date:

2.1 Select 'MONTH', enter the correct month on the keypad and select OK.

2.2 Select 'DAY', enter the correct day on the keypad and select OK.

2.3 Select 'YEAR', enter the correct last two digits of the year on the keypad and select OK.

2.4 To display the month first, followed by the day and year, select the 'MM-DD-YY' checkbox.

2.5 Select the day name shown to cycle through to display the correct weekday.

To change the time:

3.1 Select 'HOUR', enter the correct hour on the keypad and select OK.

3.2		Select 'MIN', enter the correct minutes on the keypad and select OK.
3.3		A correct date & time supports diagnosis and servicing, as logs are recorded using these date & time settings.
4.		When finished, select backspace to return to the main settings menu.

Sound levels

1.		Select the 'speaker' symbol to access the volume, tone and further sound settings.
2.		Select the 'speaker' symbol to adjust the volume level suitable for the environment from none (OFF) to the loudest (100%).
3.		Select the 'music note' symbol to set LOW, MED or HIGH tone.
4.		Select the 'keypad' symbol to switch the sound ON or OFF when the touchscreen is pressed.
5.		When finished, select backspace to return to the main settings menu.

■ Oven timer

1. 

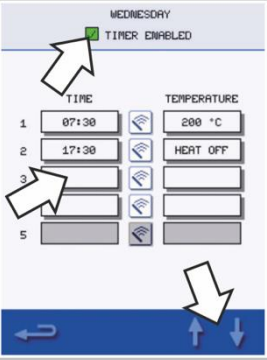
Select the 'thermometer / timer' symbol.
 2. 

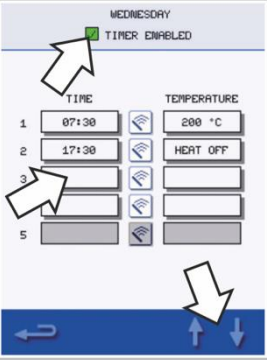
Select the 'timer enabled' checkbox (green tick).
 3. 

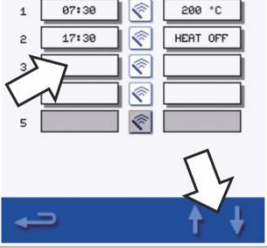
Select a weekday using the up/down arrows at the bottom of the screen.
 4. 

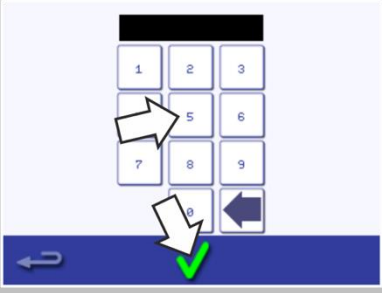
Select an empty 'time' box (maximum of 5 per day).
Alternatively clear the 'time' box using the 'wipe' symbol next to it (clears both the time and temperature for the selected line).
 5. 

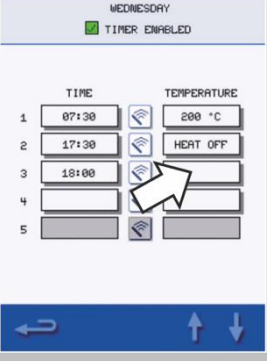
Enter the start time on the keypad.
Press the green tick to continue.
 6. 

Select an empty 'temperature' box opposite the 'time' box displaying the time just entered.
Alternatively clear the 'temperature' box using the 'wipe' symbol next to it (clears both time and temperature for the selected line).
 7. 

Enter the cavity temperature required on the keypad.
Alternatively select zero to turn the heat off, for cool down or microwave only.
Selecting the 0 to switch OFF the appliance.
Press the green tick to continue.

Note: The settings made are for that day only, allowing for different settings to be made for each day.
- 
- During a timed off period, the appliance can be used by switching the appliance off and then back on again.

■ USB

1. 

Plug in a USB key as covered in the following section 8.2.7 and select the 'USB' symbol to manually load firmware and menu programs on the oven, or to copy any of the following files from the appliance on to the USB key;

 - Menu File
 - Oven Counters
 - Error (Event) Log

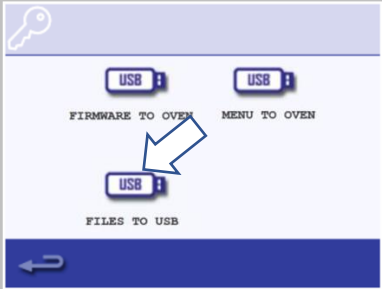

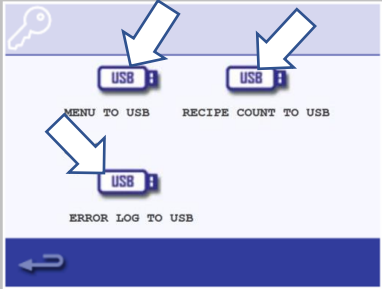
Refer to the Service and Repair Manual for instructions on manually loading menu files and operating firmware updates.
See section 8.2.7 for the standard process of loading menu files.
2. 

To copy files from the appliance on to the USB key, select 'UPLOAD TO USB'.
3. 



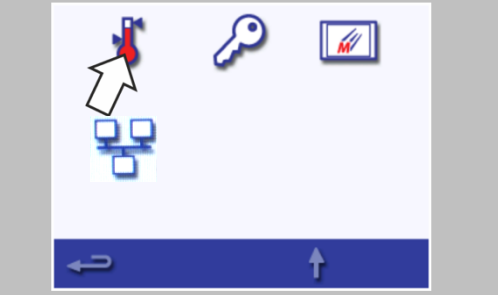
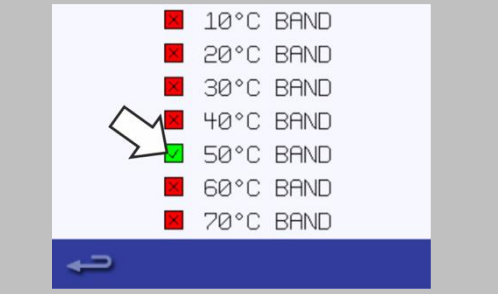

Select file to be copied and follow the on screen instructions.
4. 

When finished, select backspace to return to the main settings menu.



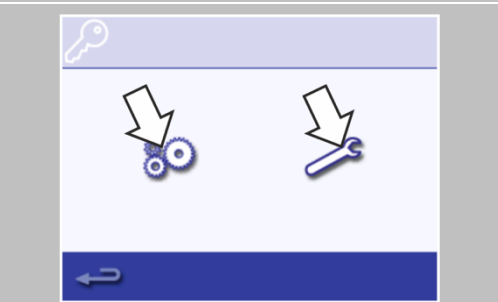
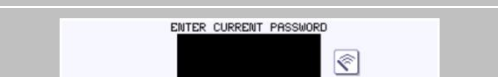

■ Temperature band

1.  Select the 'Temp Band' symbol.
2.  Select the required temperature band checkbox, shown by a green tick.
Generally, the lowest practical 'Temp Band' should be chosen.
If the set cavity temperature falls by more than the selected 'Temp Band' value, the ready to cook mode and the 'Temp Band' are deactivated until the cavity reaches the pre-set preheat temperature.
3.  When finished, select backspace to return to the main settings menu.

■ Change password

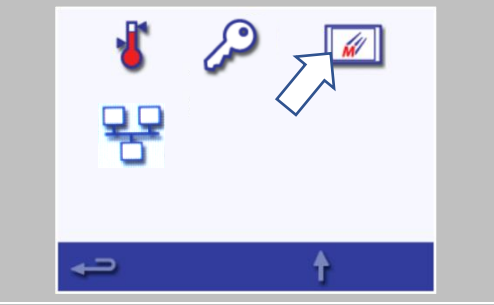
1.  Select the 'key' symbol to change the passwords of the appliance.
The default 'MANAGER' and 'SERVICE' passwords can be changed to customer specific passwords of your choice.
2.  Select the appliance 'settings' or 'service' symbol, dependant on the password you which to change.
3.  Enter the existing password and press the green tick to confirm.
4.  Then enter a new password and press the green tick.
5.  Confirm the new password and press the green tick again.
6.  When finished, select backspace to return to the main settings menu.

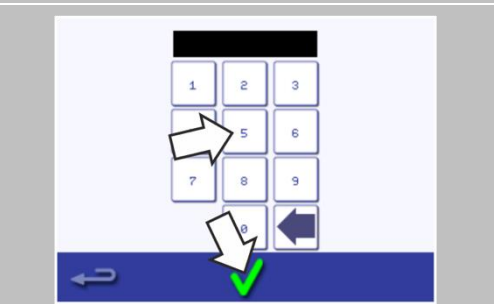
■ Set screen saver

1.  Select the 'screen saver' symbol.
2.  Select the 'ENABLED' checkbox to switch the screen saver ON or OFF. Select the 'time' box below to set or change the time setting before the screensaver is enabled.
2.  Enter a time delay on the keypad from 1 to 60 minutes before the screen saver starts. Press the green check mark to confirm.
3.  When finished, select backspace to return to the main settings menu.
4.  An active screen saver will mask the screen showing a moving image. To use the touchscreen, tap the screen to deactivate the screen saver.

■ KCCM

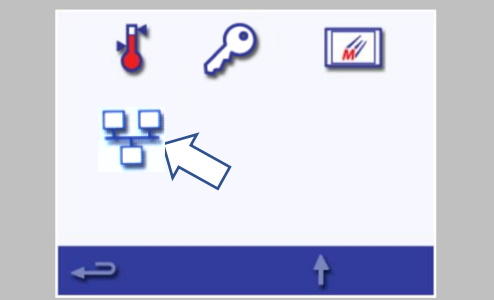
1.  The communication settings for the optional Kitchen Connect Communications Module can be accessed by selecting the 'KCCM' symbol.

(the icon is only displayed if the KCCM has been installed)

8.2.7 Using a USB stick

■ ⚠ For your safety when using the appliance

Before starting work, it is essential that you familiarize yourself with the rules and hazard warnings specified in section 8.1.1 'Working safely with the appliance', and follow the instructions given there.

■ Purpose of the USB cover

The USB cover protects the USB port so that no water vapour can get into the control electronics during cooking or cleaning. During cooking and cleaning, there must not be a USB stick inserted and the USB port must be closed by the cover.

■ USB programs

⚠ IMPORTANT

Downloading from a USB memory stick will clear all the existing programs in the memory of the appliance.

Check that the key has the correct number/code for the programs you want to load into the memory (1 '.cbr' + 'autoupd.ate').

1.

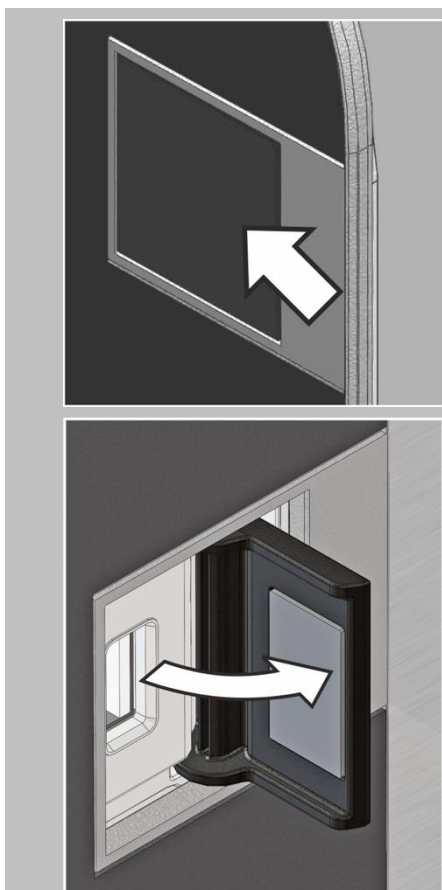

Switch the appliance OFF.

Open the cover to the USB port on the control panel.

2.

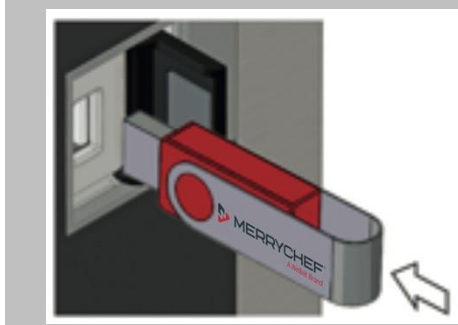

Plug in the USB memory stick.

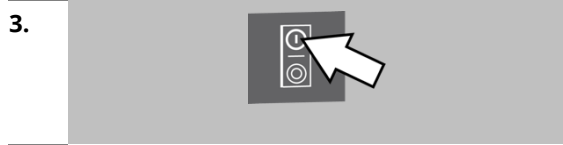

Switch the appliance ON.
The files automatically download from the USB memory stick showing the progress and confirmation screens for the update.



On completion the appliance reboots and displays the start up screen.
Then the pre-heat screen or thermometer symbol is displayed.
Remove the USB memory stick and keep it in a safe place.

9 Cleaning procedures

Purpose of this chapter

This chapter summarizes the cleaning methods, the cleaning chemicals and how to handle them and the cleaning instructions. It explains the correct procedure to follow when cleaning the microwave combination oven.

9.1 Daily cleaning tasks

Daily cleaning tasks

What must be cleaned?	Procedure	Cleaning chemicals
Cavity	Clean by hand with a soft cloth / paper towel	Cleaning and protective chemicals approved by the manufacturer
Air Filter	Clean by hand with soft cloth / sponge Rinse off after with water and dry before refitting	Common household detergent
Outside of appliance	Clean by hand with a soft cloth	Common household stainless steel cleaner or hard surface cleaner
Containers, baking sheets, shelf grills and other accessories used for cooking	<ul style="list-style-type: none"> ▪ Clean by hand with a soft non-abrasive sponge ▪ Rinse off after with water 	Common household detergent

9.2 Cleaning chemicals

Cleaning chemicals

Use solely the cleaning chemicals specified here to clean the microwave combination oven and its accessories.

Product	Use
Merrychef® Cleaner	Cleaning the cavity and appliance door
Merrychef® Protector	Protecting the cavity and appliance door
Common household stainless steel cleaner or hard surface cleaner	Caring for the external surfaces of the microwave combination oven
Common household detergent: mild on skin, alkali-free, pH-neutral and odourless	<ul style="list-style-type: none"> ▪ Cleaning components and fittings according to relevant instructions ▪ Cleaning containers, baking sheets, shelf grills and other accessories used for cooking

Handling the cleaning chemicals

You must wear personal protective equipment when using certain cleaning chemicals.

Follow the instructions given in the chapter '*Personal protective equipment*' on page 18 and the current material safety datasheets pertaining to cleaning and protective chemicals recommended by the manufacturer.

Personnel must be trained regularly by the person responsible for the microwave combination oven.

9.3 Items required for cleaning

Items required for cleaning

- Merrychef® cleaning chemical
- Merrychef® protective chemical



- Protective rubber gloves
- Non-abrasive nylon scrub pad
- Cleaning towel and cloths
- Eye protection
- Heat proof gloves (optional)
- Dust mask (optional)



NOTICE

- Never use sharp implements or harsh abrasives on any part of the appliance.
- Do not use tools.
- Do not use caustic cleaners on any part of the appliance or cavity. It will cause permanent damage to the catalytic converters.

AVIS

- Ne jamais utiliser d'ustensiles tranchants ou de produits très abrasifs, sur toute partie de l'appareil.
- Ne pas utiliser d'outils.
- Ne pas utiliser de nettoyeur caustique, sur aucune partie de l'appareil ou de l'espace intérieur. Cela provoquerait des dommages irréversibles aux catalyseurs.



9.4 Safe working when cleaning

Your safety and the safety of your staff

Instruct your personnel to learn the safe-working rules given in this section before starting work, and to follow them strictly.

Instruct your personnel to familiarize themselves with the hazard warnings listed in this section and in further instructions below and instil in them the importance of taking the specified precautions.

Personal protective equipment for your personnel

Instruct your personnel to wear the correct personal protective equipment specified in the section '*Personal protective equipment*' on page 18

■ Rules for moving and setting up the wheeled trolley safely

To avoid hazards, the following rules must be observed when moving the wheeled trolley that carries the appliances (optional accessory):

- Watch out for all connecting cables when moving appliances. Never wheel over the connecting cables. Never stretch let alone pull off the connecting cables.
- The appliances must be disconnected from the electrical supply before moving the stacking trolley (optional accessory).
- The appliances must be left to cool down on the trolley before being moved.
- There must not be any food left in the appliances.
- The appliance door must be closed.
- Protective clothing must be worn if the appliance is mounted on a trolley.
- It is important to ensure that the unit is level once is back in place.
- Once the unit is back in place, the parking brakes must be engaged again.
- Whatever the position, care must be taken to ensure that the trolley carrying the appliance does not tip over.

■ Spraying down the appliance with water

DANGER

Risk of electric shock from live parts

Water on the exterior of the appliance can cause a short-circuit, which may result in electric shock on touching the appliance.

- ▶ Do not spray the interior and exterior of the appliance with water.
- ▶ Always keep the USB cover closed during cleaning.

■ Hot surfaces

WARNING

Risk of burns from high temperatures on interior parts of the appliance

You may get burnt if you touch any of the interior parts of the cavity, the inside of the appliance door or any parts that are or were inside the oven during cooking.

- ▶ Before starting cleaning tasks, wait until the cavity has cooled to below 50°C / 122°F or use the Cool Down function to cool the cavity.
- ▶ Wear personal protective equipment.

■ Spraying water into a hot cavity

WARNING

Risk of scalding from hot steam

If water is sprayed into the hot cavity, steam will be produced that may scald.

- ▶ Before starting cleaning tasks, wait until the cavity has cooled to below 50°C / 122°F or use the 'Cool Down' function to cool the cavity.

■ Contact with cleaning chemicals

WARNING

Risk of irritation to skin, eyes and respiratory system.

Direct contact with the cleaning or protective chemicals will irritate the skin, eyes and respiratory system.

- ▶ Do not inhale the vapours or spray mist from the cleaning and protective chemicals.
- ▶ Do not let the cleaning or protective chemicals come into contact with skin, eyes or mucous membranes.
- ▶ Do not spray cleaning or protective chemicals into a cavity.
- ▶ Wear personal protective equipment.

■ Not washing off the cleaning chemicals

WARNING

Risk of food contamination from cleaning chemicals.

Wash off the cleaning chemicals from the cavity using a clean cloth and plenty of clean warm water, then wipe with a soft cloth or paper towel, to ensure no risk of food contamination from cleaning chemicals.

■ **9.5 Cleaning procedures**

■ Cleaning the microwave combination oven

This section explains how to clean your microwave combination oven.

■ **9.5.1 Cool down procedure before cleaning**

■ Purpose

With the optional 'cool down' function you can cool down the cavity quickly for cleaning your microwave combination oven sooner.



Cooling down the cavity



In 'Full Serve mode', select the 'cleaning' symbol from the main menu.

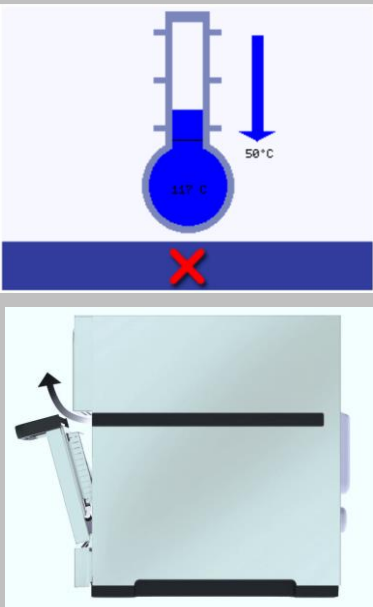

In 'Full' or 'Quick Serve mode', select the 'blue thermometer' symbol to disable heating and to start the cooling cycle. A prompt appears.

- 3**
- 
- Taking all necessary precautions place a suitable tray of ice cubes or cold water into the hot cavity. This speeds up the cooling process.
- Once the tray of ice is in the oven, press the green tick to continue.
-
- 5.**
- 
- The cooling progress is displayed and takes approximately 20 minutes.
- To reduce the cool down time, leave the appliance door open slightly during the cooling process.
-
- 6.**
- 
- Once the cooling process is complete, carefully remove the cool down pan from the cavity wearing protective gloves. The pan of water should not be left in the oven overnight or when cold.
- The oven is now ready for cleaning and a prompt appears on screen.

9.5.2 Cleaning instructions

Requirements for cleaning the appliance

- The appliance has been cooled down correctly.
- No food has been left in the cavity.
- All containers, baking sheets, shelf grills and any other accessories have been removed from the cavity.

Cleaning process

Cleaning oven and oven parts

- 

Open the appliance door and remove the cook plate and any other cooking accessories from the cavity.

NOTE: You can at this stage also remove the air filter to wash it with the other parts (see steps 12-13 for instructions on how to remove the air filter) or you can remove and clean the air filter later (steps 12-17).

! CAUTION: Wear protective glasses and protective rubber gloves during the cleaning procedure.
- Wash the removed cook plate and oven accessories in warm soapy water.

Wash off using a clean cloth and plenty of clean, warm water.

Dry all components using a fresh, clean cloth.
- 

Remove any spillages with suitable cloth or paper towel.

Use a dry clean brush to remove any food particles from between the cavity floor and the inside of the front door.
- 

Carefully spray cleaning chemical approved by Merrychef® onto a sponge.



Clean all surfaces of the cavity **except the roof (jet plate) and door seal.**

NOTICE:

Do not spray directly into the cavity.

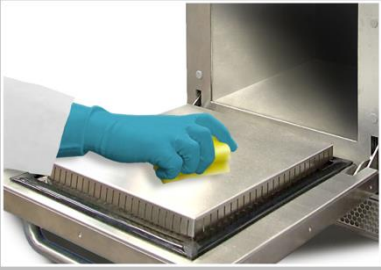

Do not use cleaning chemicals or oven protector on the roof of the cavity.

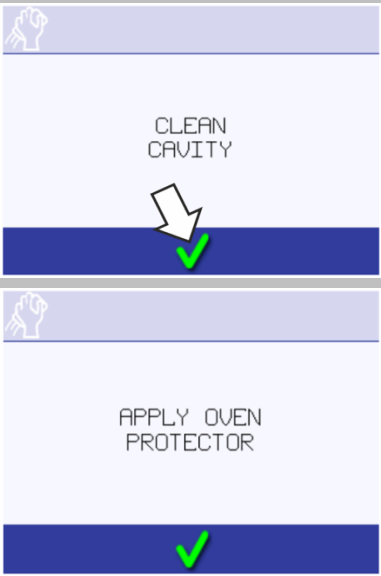
Do not use cleaning chemicals or oven protector on the cook plate.



5.		<p>For difficult areas, leave to soak for 10 minutes with the appliance door open.</p> <p>Use a non-abrasive nylon scrub pad/sponge to clean all surfaces of the cavity and the inside surface of the appliance door.</p> <p>NOTICE: Do not scrub the roof (jet plate) or door seal or use metallic scourers.</p>
6.		<p>Wash off all surfaces using a wet, clean cloth.</p> <p>Dry using a fresh, clean cloth or paper towel.</p> <p>If required, the cavity roof and door seal can be wiped clean with a wet clean cloth as well.</p>
7.		<p>Press the green tick to confirm the cavity has been cleaned.</p> <p>You will be prompted to apply protective chemical (oven protector).</p> <p>NOTE: The application of protective chemical is optional but recommended to make cleaning easier the next day.</p> <p>Follow steps 8-11 below to apply oven protector</p> <p style="text-align: center;">or</p> <p>Press the second green tick to skip applying the protective chemical, replace the cook plate and any other parts removed for cleaning and go to step 12 to complete the remaining cleaning procedures.</p>

Applying the protective chemical (optional)

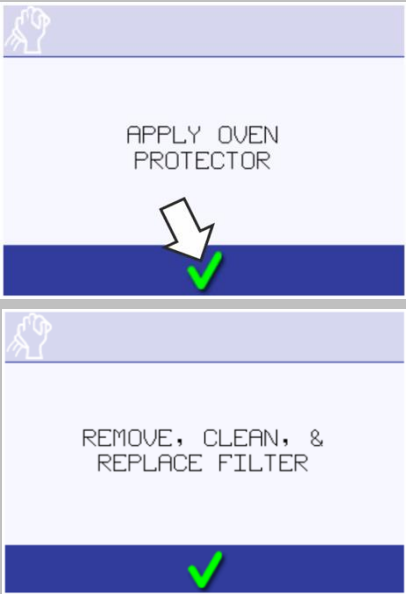

8.		<p>Spray protective chemical approved by Merrychef® onto a clean sponge.</p> <p>NOTICE: Only apply the protective chemical to a clean appliance. Ensure protector is only wiped on cavity metal surfaces. Ensure the oven is heated before putting cook plate in.</p>
----	---	---

9.  Spread the protective chemical lightly onto all internal surfaces of the appliance **avoiding the roof (jet plate) and door seal (marked in red).**
10.  Close the appliance door.
11.  Press the green tick to confirm application of the protective chemical.
When the green tick is pressed, a prompt appears asking to clean the air filter.

Cleaning the air filter

12.		<p>With the oven door closed, tilt the faceplate below the door downwards.</p>
13.		<p>Remove the air filter by gently pulling it out.</p>
14.		<p>Clean the air filter with a damp cloth or wash it in soapy water and dry it thoroughly.</p>
15.		<p>Replace the air filter and tilt the faceplate in its original position.</p>
16.		<p>Clean the oven exterior with a damp cloth.</p>
17.		<p>Press the green tick to confirm cleaning of the air filter. The oven switches OFF.</p> <p>The oven is now ready to be used again if you did not apply protective chemical. If protective chemical was applied, it must be cured, go to step 18.</p> <p>Manually switch the oven off on completion.</p>

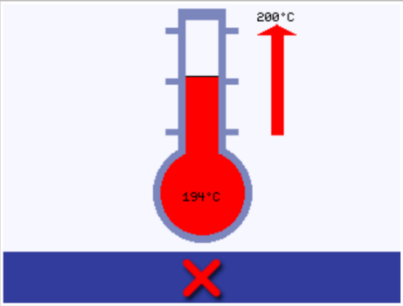
Curing protective chemical

18.  Switch ON the appliance.
- NOTE:** If the air filter has not been replaced the screen will display a warning. Replace the air filter and then press the green tick to continue.
19.  Preheat the cavity.
- Once reaching the pre-set operating temperature it will take about 30 minutes to cure the protective chemical, if it was applied.
- The protective chemical turns light brown when cured.
20.  Replace the cleaned and dried cook plate and any other parts removed for cleaning.
- Ensure the cook plate / wire rack is fitted on to the cavity support stubs.
- The oven is now ready again for cooking.

10 Taking the appliance out of operation and disposal

Purpose of this chapter

In this chapter it is explained how to take your microwave combination oven out of operation and dispose of it.



10.1 Safe working when taking the appliance out of operation

Eligibility of personnel for taking the appliance out of operation

Work performed on the appliance while taking it out of service is performed in special operating circumstances, or includes activities that require personnel to have relevant qualifications and appliance-specific knowledge that exceed the requirements for operating personnel.

The following requirements must be met by personnel:

- They are qualified employees of an authorized service company.
- Personnel have relevant training as a service engineer.
- Personnel have training specific to the appliance.

Personal protective equipment

Wear the personal protective equipment specified in the section '*Personal protective equipment*' on page 18 of the '*For your safety*' chapter for the relevant tasks.

Rules for safe and responsible working when taking the appliance out of operation

Avoid any risks to yourself and others by following the rules below:

- The kitchen floor must always be kept dry to reduce the risk of accidents.
- The appliance door of the microwave combination oven must be closed before disposing of the appliance.
- Don't leave food in the cavity.

Live parts

DANGER

Risk of electric shock from live parts and loose cables

When the panels are removed, there is a risk of electric shock from touching live parts.

- Make sure that any work on the electrical system is performed solely by a competent electrician from an authorized service company.

Moving heavy loads

WARNING

Risk of injury from lifting incorrectly

When lifting the appliance, the weight of the appliance may lead to injuries, especially in the area of the torso.

- Use a fork-lift truck/pallet truck to move the appliance.
- When lifting the appliance, use enough people for the weight of the appliance (value depending on age and gender). Observe the local occupational safety regulations.
- Wear personal protective equipment.

■ Unsuitable supporting surface

WARNING

Risk of crushing if the appliance tips over or falls off

Body parts can be crushed if the appliance tips over or falls off.

- Make sure that the appliance is never placed on an unsuitable supporting surface.

10.2 Taking the appliance out of operation and disposal

■ Requirements

Before taking the appliance out of service, check that the appliance is de-energized.

■ Taking the appliance out of operation

To take your appliance out of operation, follow the steps for setting up and installing your appliance in the reverse order (see the chapters '*Installation*' on page 29, '*Moving the appliance*' on page 21 and '*Setting up the appliance*' on page 22).

Do not move the appliance until you have disconnected all the electrical connections.

■ Disposal

Correct disposal of this product (Waste Electrical & Electronic Equipment)

Applicable in the European Union and other European countries with separate collection systems.



This marking shown on the product or its literature indicates that it must not be disposed with other household wastes at the end of its working life. To prevent possible harm to the environment or human health from uncontrolled waste disposal, please separate this from other types of wastes and recycle it responsibly to promote the sustainable reuse of material resources.

Household users should contact either the retailer where they purchased this product, or their local government office for details of where and how they can take this item for environmentally safe recycling.

Business users should contact their supplier and check the terms and conditions of the purchase contract. This product must not be mixed with other commercial wastes for disposal.

11 Technical data

Purpose of this chapter

This chapter contains the technical data for your microwave combination oven.

11.1 Technical data

Dimensions and weights

Width				
Including packaging	535	[mm]	21.1	[in]
Appliance without packaging	356	[mm]	14.0	[in]
Height				
Including packaging	850	[mm]	33.5	[in]
Appliance ("Classic" exterior) without packaging	620	[mm]	24.4	[in]
Appliance ("Trend" exterior) without packaging	644	[mm]	25.4	[in]
Depth				
Including packaging	895	[mm]	35.3	[in]
Appliance without packaging, door closed	636	[mm]	25.0	[in]
Weight				
High Power version, including packaging	70.4	[kg]	155	[lbs]
High Power version, excluding packaging	61.0	[kg]	134	[lbs]
Standard Power version, including packaging	61.1	[kg]	135	[lbs]
Standard Power version, excluding packaging	51.7	[kg]	144	[lbs]
Safety clearances				
Rear / right / left	0	[mm]	0	[in]
Top (for ventilation)	50	[mm]	2	[in]

Electrical connected load ratings – High power version

Electrical supply		1N~ 220-230V 50Hz	2N~ 380-400V 50Hz	1N~ 220V 60Hz	2~ 200V 50/60Hz
Connections used		L + N + E	L1 + L2 + N + E	L + N + E	2P + GND
Arrangement		Single Phase	Twin Phase	Single Phase	Two Pole
Rated power consumption	[W]	6000	2500 + 3300	6000	6000
Rated current per phase	[A]	32	16 / 32	32	32
Power output					
Rated power output convected heat	[W]	2200	2200	2200	2000
Rated power output microwave (IEC 705) 100%	[W]	2000	2000	2000	2000
Rated power output combination mode	[W]	2200 + 2000	2200 + 2000	2200 + 2000	2000 + 2000

■ Electrical connected load ratings – Standard power version

Electrical supply		1N~ 220-230V 50Hz	1N~ 220-230V 50Hz	1N~ 220V 60Hz
Connections used		L + N + E	L + N + E	L + N + E
Arrangement		Single Phase	Single Phase	Single Phase
Rated power consumption	[W]	2990	3680	2860
Rated current per phase	[A]	13	16	13
Power output				
Rated power output convected heat	[W]	2200	2200	2200
Rated power output microwave (IEC 705) 100%	[W]	1000	1000	1000
Rated power output combination mode (convected heat + microwave)	[W]	900 + 1000	1300 + 1000	900 + 1000

■ Regulatory standards compliance

Degree of protection	IPX0
Noise emission	max. 70 [dBA]
Approval marks	
Tested safety	CE, CB (IEC), UL
Hygiene	UL-EPH (NSF/ANSI 4)

11.2 Dimensional drawings

eikon® e2s

Front view (door closed)

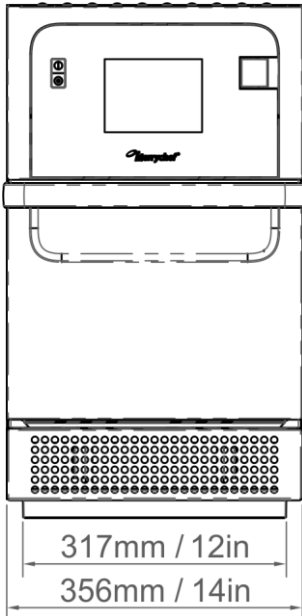

Cavity dimensions (door closed)

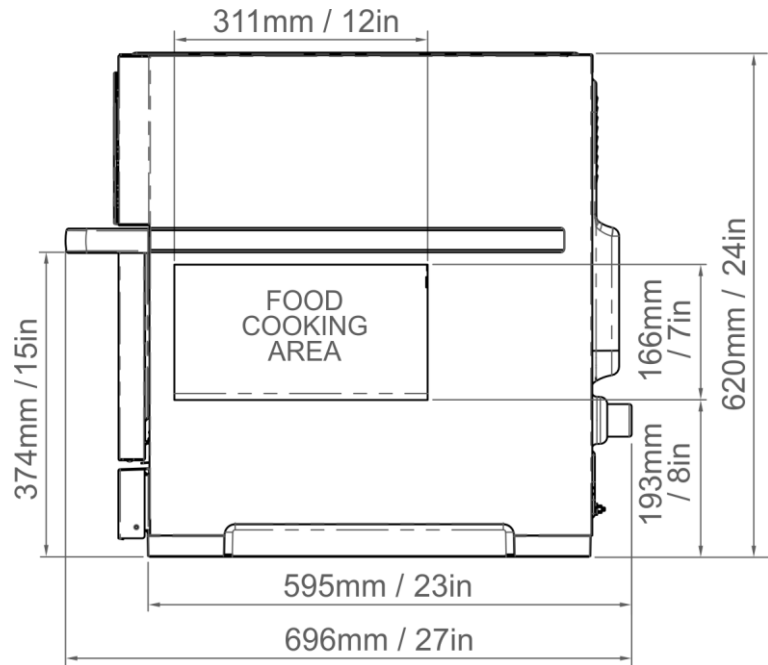

View from the top (door closed)

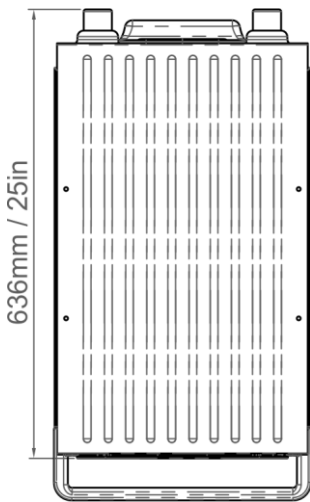

View from the right hand side (door open)

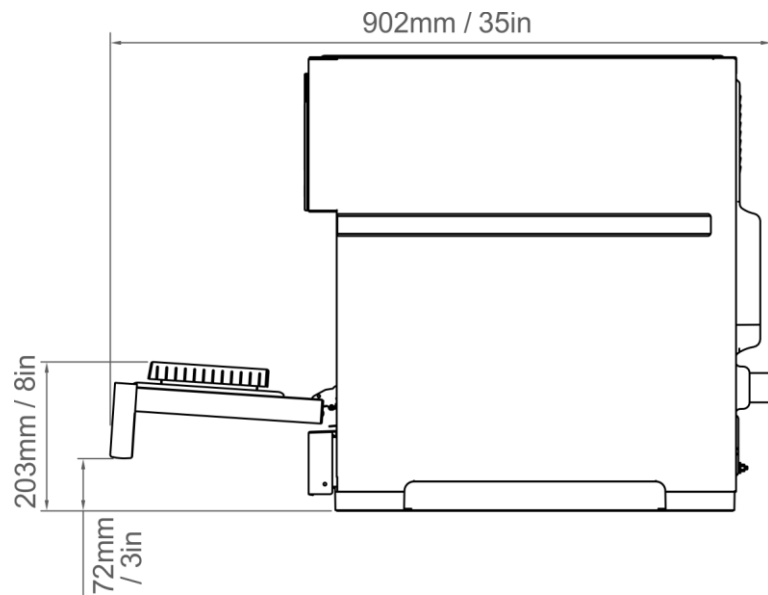

12 Servicing information

Purpose of this chapter

To inform about the correct procedure to follow during servicing and summarizes possible faults with the appliance and errors that may arise during operation.

12.1 Warranty information and contacting customer service

Warranty information

In order to be able to claim under the warranty for the microwave combination oven, the appliance must be installed in accordance with the instructions in the Installation and User Manual by a qualified service engineer from an authorized service company.

The warranty does not cover damage resulting from improper setup, installation, use, cleaning, use of cleaning chemicals, servicing or repair.

Required information

Please have the following appliance data to hand when contacting our customer service:

- Model, or item number of your appliance (see '*Identifying your microwave combination oven*' on page 7)
- Serial number of your appliance (see '*Identifying your microwave combination oven*' on page 7)

Contact data

Welbilt UK Ltd.
Ashbourne House, The Guildway,
Old Portsmouth Road
Guildford, GU3 1LR
United Kingdom

Reception

Phone (head office) (+44) (0) 1483 464900

Fax (+44) (0) 1483 464905

Internet www.merrychef.com
www.welbilt.com

12.2 Rectifying faults: problems in operation

Fault finding chart

Although every effort is made to ensure your oven will continue to perform to a high standard, please check the chart to see if the problem can be easily resolved before contacting your service agent.

Problem	Possible cause	Remedy
The appliance does not work, and the display screen is blank	The appliance has no power	<ul style="list-style-type: none"> ▪ Check if there is a power cut. ▪ Check if the isolator switch is ON or the appliance is plugged in correctly. ▪ Check if the appliance switch is ON.
Some screen controls do not work	Unauthorised access	Contact an authorised user.
Display shows a warning message	Details are shown on screen	Follow the instructions displayed.
The appliance does not cook the food correctly	<ul style="list-style-type: none"> ▪ Appliance is not clean ▪ Food not at correct temperature ▪ Modified or wrong program selected ▪ Food wrapped ▪ Food removed early 	<ul style="list-style-type: none"> ▪ Clean the appliance (see '<i>Cleaning Instructions</i>' on page 73) ▪ Use the correct cooking program. ▪ Unwrap food. ▪ Check if all the cooking stages have been followed correctly.
The appliance does not finish cooking	<ul style="list-style-type: none"> ▪ Warning message displayed ▪ The appliance door is open ▪ No air filter or incorrectly fitted ▪ Overheating of the appliance 	<ul style="list-style-type: none"> ▪ Close the appliance door. ▪ Refit the air filter. ▪ Allow the appliance to cool down. ▪ Check and remove any restrictions around the air vents.
Display shows an error code	Malfunction of the appliance	Note the error code and contact your service agent.

Microwave Combination Oven

Merrychef eikon® e2s

Part Number 32Z3933 (USA/CA)

Version 1

Approvals:

