



14 GAUGE STAINLESS STEEL

ONE STATION FLOOR MOUNTED SERVICE SINK WITH TUBULAR LEGS TOE-PUSH OPERATED



Foot Valves Included
On All "FV" Models

Item #: _____ Qty #: _____
 Model #: _____
 Project #: _____



FEATURES:

- 8 1/2" high backsplash.
- 10" sink bowl depth.
- One stainless steel "Z" bracket supplied each unit.
- One **K-6** 3 1/2" rear basket drain.
- Four tubular stainless steel legs with stainless steel bullet feet.
- One stainless steel support shelf with rear turn-up.
- Toe-Push Operated:** Includes one **K-104** toe-push valve and one **K-121** spout.
- Single hole provided.

CONSTRUCTION:

- All TIG welded.
- Welded areas blended to match adjacent surfaces and to a satin finish.
- Die formed tubular wall brackets.

MATERIAL:

- All 14 gauge type "304" stainless steel.
- 1 5/8" tubular "304" stainless steel legs.
- Stainless steel gussets.

MECHANICAL:

- Single faucet holes.

Model #	Length	# of Spouts	# of Legs	Wt.	Cu.Ft.
FS-FM-2219FV	23"	1	4	94 lbs.	21

[Click Here For Install Guide](#)



MULTI-STATION ACCESSORIES & REPLACEMENT PARTS

Model	Description	QTY:
K-6	3 1/2" Drain (1 1/2" I.P.S.)	_____
K-06	Splash Mount Faucet Mounting Kit	_____
K-13	Stainless Steel Soap Dispenser (Wall Mount Only)	_____
K-104	Toe-Push Valve Assembly	_____
K-121	Single Hole, Splash Mounted 3-1/2" Gooseneck Spout	_____
K-410	Strainer Plate for 3-1/2" Drain	_____
K-508	Special Sizing Charge (<i>Larger Size Cut Down To Smaller Size</i>)	_____
TA-19	Adjustable Stainless Steel Flanged Bullet Foot	_____



K-121



K-104



K-13



K-410



K-06

TA-19

= Ships UPS

Standard Faucets conform to NSF 61 Standard 9 and compliance to AB 1953 Standards.



Customer Service Available To Assist You 1-800-645-3166 8:30 am - 7:00 pm E.S.T.

For Orders & Customer Service:

Email: customer@advancetabco.com or Fax: 631-242-6900

For Smart Fabrication™ Quotes:

Email: smartfab@advancetabco.com or Fax: 631-586-2933

DETAILS and SPECIFICATIONS

TOL ± .500"

ALL DIMENSIONS ARE TYPICAL

FS-FM-2219FV

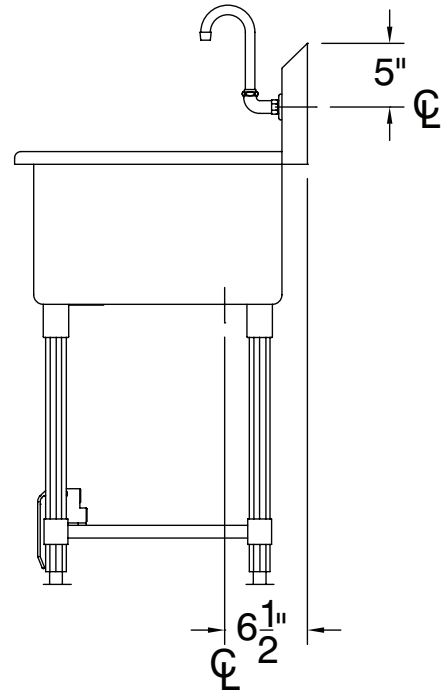
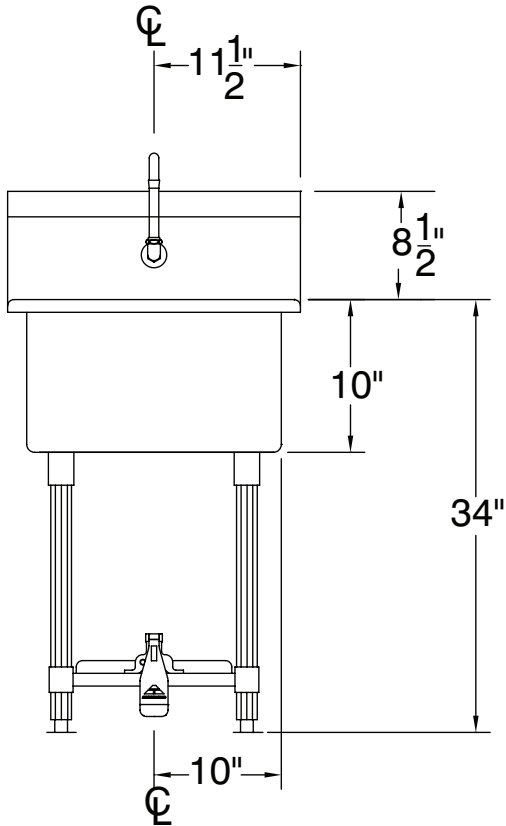
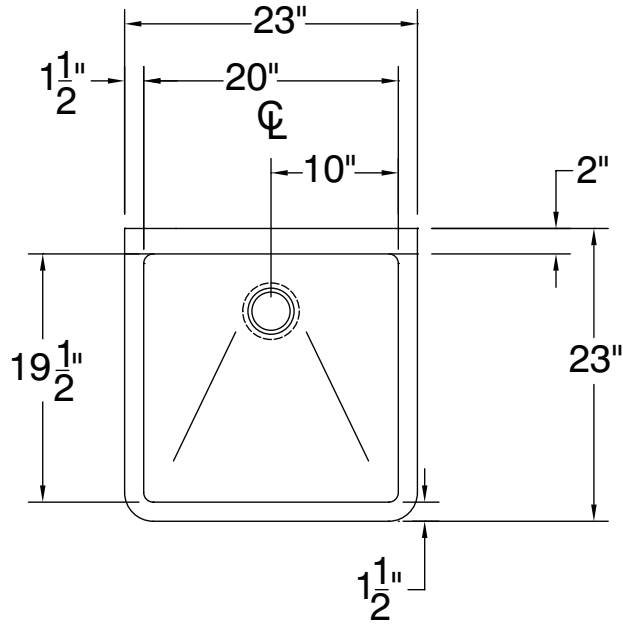

78 Lbs.

