

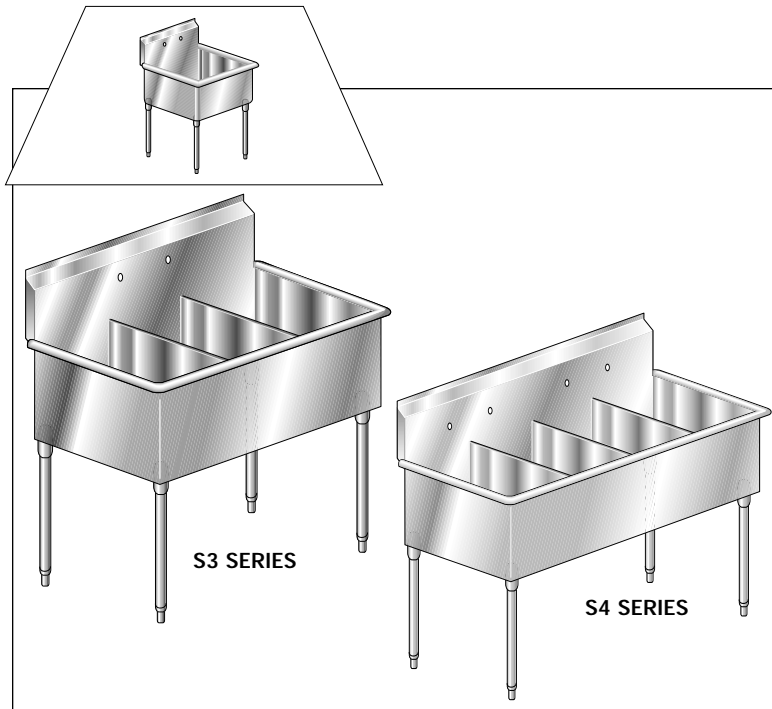

NON-NSF SINKS

S3/S4 SERIES, Three/Four Compartment



Item# _____ Project _____

S3 SERIES, Three Compartment Sinks

Quantity	ECONOMY 4S3 Model #	DELUX 3S3 Model #	PREMIUM 2S3 Model #
----------	---------------------------	-------------------------	---------------------------

18" WIDE

_____	4S3-1812	3S3-1812	2S3-1812
_____	4S3-1814	3S3-1814	2S3-1814
_____	4S3-1816	3S3-1816	2S3-1816
_____	4S3-1818	3S3-1818	2S3-1818
_____	4S3-1820	3S3-1820	2S3-1820
_____	4S3-1824	3S3-1824	2S3-1824

21" WIDE

_____	4S3-2112	3S3-2112	2S3-2112
_____	4S3-2114	3S3-2114	2S3-2114
_____	4S3-2116	3S3-2116	2S3-2116
_____	4S3-2118	3S3-2118	2S3-2118
_____	4S3-2120	3S3-2120	2S3-2120
_____	4S3-2124	3S3-2124	2S3-2124

24" WIDE

_____	4S3-2412	3S3-2412	2S3-2412
_____	4S3-2414	3S3-2414	2S3-2414
_____	4S3-2416	3S3-2416	2S3-2416
_____	4S3-2418	3S3-2418	2S3-2418
_____	4S3-2420	3S3-2420	2S3-2420
_____	4S3-2424	3S3-2424	2S3-2424

30" WIDE

_____	4S3-3012	3S3-3012	2S3-3012
_____	4S3-3014	3S3-3014	2S3-3014
_____	4S3-3016	3S3-3016	2S3-3016
_____	4S3-3020	3S3-3020	2S3-3020
_____	4S3-3024	3S3-3024	2S3-3024

S4 SERIES, Four Compartment Sinks

Quantity	ECONOMY 4S4 Model #	DELUX 3S4 Model #	PREMIUM 2S4 Model #
----------	---------------------------	-------------------------	---------------------------

21" WIDE

_____	4S4-2112	3S4-2112	2S4-2112
_____	4S4-2116	3S4-2116	2S4-2116
_____	4S4-2118	3S4-2118	2S4-2118

MATERIAL

BODY

- 4S-16 gauge 430 stainless steel.
- 3S-16 gauge 304 stainless steel.
- 2S-14 gauge 304 stainless steel.

LEGS

- 1½" O.D. 16 gauge 304 series stainless steel tubing, complete with 1" adjustable impact resistant white metal feet.

DESIGN FEATURES

- All sinks are fully cartoned.
- Easily assembled.

EXCLUSIVE AERO SAFETY EDGE

- Sink hemmed on the roll and backsplash to eliminate cuts from rough edges.

CONSTRUCTION

- Machine welded for superior weld and polish.
- Stainless steel gusset is machine welded 360 deg. to a stainless steel triangular plate.
- Gusset plate is fully welded directly underneath the sink.
- ½" roll on the top edge of the divider to create rigidity and eliminate burrs.
- Polished to a #4 blended finish.

PLUMBING

- Water supply is ½" hot and cold.
- Faucet holes are 8" o.c. (Faucets not included. See accessories).
- Two sets faucet holes on sinks 60" or larger.

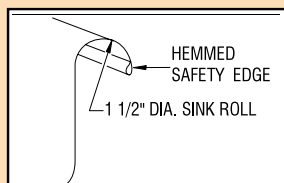

Exclusive Aero Safety Edge

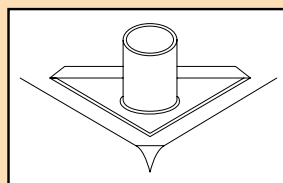

Fully Welded Gusset Assembly

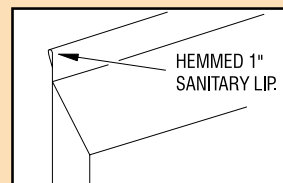

1" Sanitary Lip

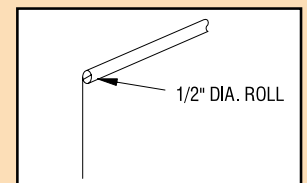

1/2" Roll for Extra Rigidity

email - sales@aeromfg.com

AERO MANUFACTURING COMPANY • 310 ALLWOOD ROAD, CLIFTON, NEW JERSEY 07012 • VOICE 973.473.5300 FAX 973.473.3794



DIMENSIONAL SPECIFICATIONS

S3/S4 SERIES, Three/Four Compartment, NON-NSF Sinks

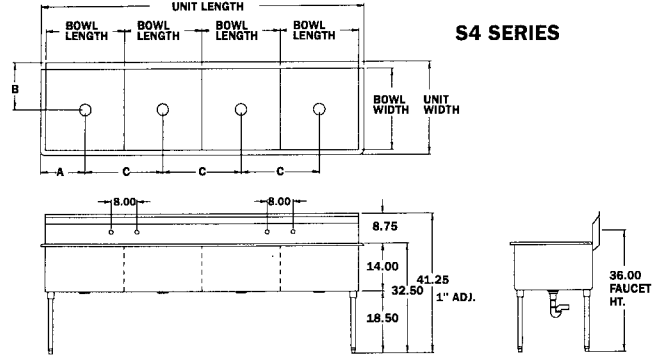
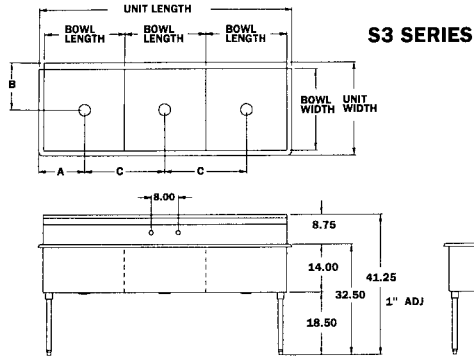

■ Supplied with stainless steel drain basket and strainer.

S3 SERIES, Three Compartment Sinks

BOWL Width	BOWL Length	UNIT Width	UNIT Length	A Drain	B Drain	C Drain	ECONOMY 4S3 Model #	DELUX 3S3 Model #	PREMIUM 2S3 Model #	Ship Weight	Cubic Feet	Sets, Faucet Holes
------------	-------------	------------	-------------	---------	---------	---------	---------------------	-------------------	---------------------	-------------	------------	--------------------

18" WIDE

18	12	21.5	39	7.5	11	12	4S3-1812	3S3-1812	2S3-1812	61	10	ONE
18	14	21.5	45	8.5	11	14	4S3-1814	3S3-1814	2S3-1814	71	12	ONE
18	16	21.5	51	9.5	11	16	4S3-1816	3S3-1816	2S3-1816	81	13	ONE
18	18	21.5	57	10.5	11	18	4S3-1818	3S3-1818	2S3-1818	91	15	ONE
18	20	21.5	63	11.5	11	20	4S3-1820	3S3-1820	2S3-1820	101	16	TWO
18	24	21.5	75	13.5	11	24	4S3-1824	3S3-1824	2S3-1824	111	20	TWO

21" WIDE

21	12	24.5	39	7.5	12.5	12	4S3-2112	3S3-2112	2S3-2112	65	12	ONE
21	14	24.5	45	8.5	12.5	14	4S3-2114	3S3-2114	2S3-2114	76	13	ONE
21	16	24.5	51	9.5	12.5	16	4S3-2116	3S3-2116	2S3-2116	81	15	ONE
21	18	24.5	57	10.5	12.5	18	4S3-2118	3S3-2118	2S3-2118	96	17	ONE
21	20	24.5	63	11.5	12.5	20	4S3-2120	3S3-2120	2S3-2120	111	19	TWO
21	24	24.5	75	13.5	12.5	24	4S3-2124	3S3-2124	2S3-2124	126	22	TWO

24" WIDE

24	12	27.5	39	7.5	14	12	4S3-2412	3S3-2412	2S3-2412	69	13	ONE
24	14	27.5	45	8.5	14	14	4S3-2414	3S3-2414	2S3-2414	87	15	ONE
24	16	27.5	51	9.5	14	16	4S3-2416	3S3-2416	2S3-2416	97	17	ONE
24	18	27.5	57	10.5	14	18	4S3-2418	3S3-2418	2S3-2418	119	19	ONE
24	20	27.5	63	11.5	14	20	4S3-2420	3S3-2420	2S3-2420	139	21	TWO
24	24	27.5	75	13.5	14	24	4S3-2424	3S3-2424	2S3-2424	159	25	TWO

30" WIDE

30	12	33.5	39	7.5	17	12	4S3-3012	3S3-3012	2S3-3012	85	16	ONE
30	14	33.5	45	8.5	17	14	4S3-3014	3S3-3014	2S3-3014	100	18	ONE
30	16	33.5	51	9.5	17	16	4S3-3016	3S3-3016	2S3-3016	115	21	ONE
30	18	33.5	57	10.5	17	18	4S3-3018	3S3-3018	2S3-3018	135	23	ONE
30	20	33.5	63	11.5	17	20	4S3-3020	3S3-3020	2S3-3020	145	26	TWO
30	24	33.5	75	13.5	17	24	4S3-3024	3S3-3024	2S3-3024	175	31	TWO

S4 SERIES, Four Compartment Sinks

BOWL Width	BOWL Length	UNIT Width	UNIT Length	A Drain	B Drain	C Drain	ECONOMY 4S4 Model #	DELUX 3S4 Model #	PREMIUM 2S4 Model #	Ship Weight	Cubic Feet	Sets, Faucet Holes
------------	-------------	------------	-------------	---------	---------	---------	---------------------	-------------------	---------------------	-------------	------------	--------------------

21" WIDE

21	12	24.5	51	7.5	12.5	12	4S4-2112	3S4-2112	2S4-2112	91	15	ONE
21	16	24.5	67	9.5	12.5	16	4S4-2116	3S4-2116	2S4-2116	121	20	TWO
21	18	24.5	75	10.5	12.5	18	4S4-2118	3S4-2118	2S4-2118	136	22	TWO

All dimensions are typical (tol. ±1/2"). • For Accessories and Options see pages FS-7A, FS-7B.
email - sales@aeromfg.com

AERO MANUFACTURING COMPANY • 310 ALLWOOD ROAD, CLIFTON, NEW JERSEY 07012 • VOICE 973.473.5300 FAX 973.473.3794