

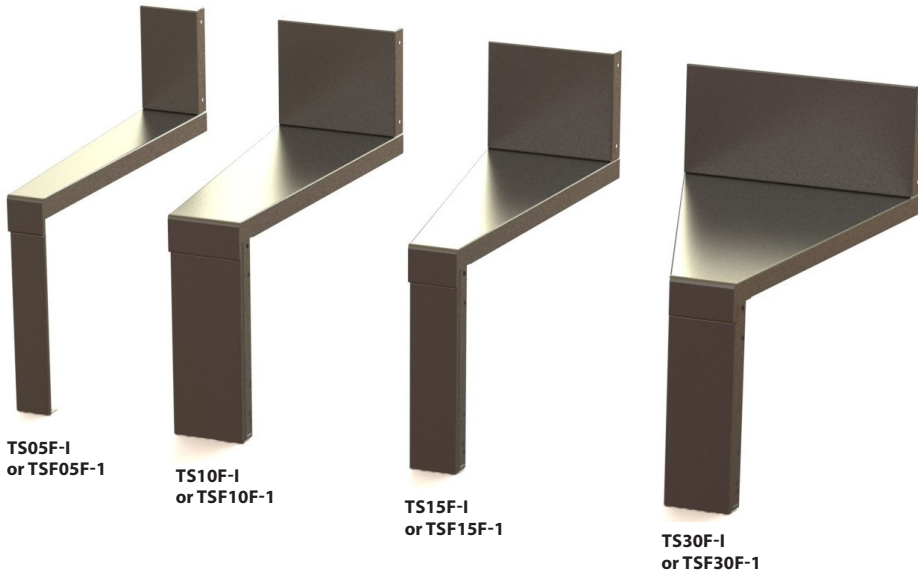

UNDERBAR CORNER SECTIONS
Angled Corners with Flat Tops



JOB
AREA
ITEM NO.
MODEL NO.

MODELS	
TS SERIES	TSF SERIES
Inside Angle Fillers	
TS05F-I	TSF05F-I
TS10F-I	TSF10F-I
TS15F-I	TSF15F-I
TS20F-I	TSF20F-I
TS25F-I	TSF25F-I
TS30F-I	TSF30F-I
TS45F-I	TSF45F-I
TS60F-I	N/A
TS75F-I	N/A
TS90F-FI	TSF90F-FI
TS90F-I	TSF90F-I
Outside Angle Fillers	
TS15F-O	TSF15F-O
TS20F-O	TSF20F-O
TS25F-O	TSF25F-O
TS30F-O	TSF30F-O
TS45F-O	TSF45F-O
TS60F-O	N/A
TS90F-O	TSF90F-O

KEY PRODUCT FEATURES AND BENEFITS

- Angled flat top sections come in various degrees for inside and outside corner applications
- Design provides clearance for beverage and utility lines to transition around the corner without hard bends in the lines
- Stainless steel surface is durable, rust resistant, easy to clean and provides extra work or storage space
- Tool-less, screw-in legs for fast, easy installation, and available when there are not two adjacent units to attach to
- Can be mounted to any adjacent stable surface

Quick Features:

- Designed to mount between two adjacent underbar units to complete an inside turn
- Flat tops are easy to clean
- All stainless construction for durability

MODEL NUMBERS - TS05F-I, TSF05F-I, TS10F-I, TSF10F-I, TS15F-I, TSF15F-I, TS20F-I, TSF20F-I, TS25F-I, TSF25F-I, TS30F-I, TSF30F-I, TS45F-I, TSF45F-I, TS60F-I, TSF60F-I, TS75F-I, TSF75F-I, TS90F-FI, TSF90F-FI, TS90F-I, TSF90F-I, TS15F-O, TSF15F-O, TS20F-O, TSF20F-O, TS25F-O, TSF25F-O, TS30F-O, TSF30F-O, TS45F-O, TSF45F-O, TS60F-O, TSF60F-O, TS90F-O, TSF90F-O



UNDERBAR CORNER SECTIONS
Angled Corners with Flat Tops

MODEL NUMBERS - TS05F-I, TSF05F-I, TS10F-I, TSF10F-I, TS15F-I, TSF15F-I, TS20F-I, TSF20F-I, TS25F-I, TSF25F-I, TS30F-I, TSF30F-I, TS45F-I, TSF45F-I, TS60F-I, TSF60F-I, TS75F-I, TSF75F-I, TS90F-I, TSF90F-I, TS20F-O, TSF20F-O, TS25F-O, TSF25F-O, TS30F-O, TSF30F-O, TS45F-O, TSF45F-O, TS60F-O, TSF60F-O, TS90F-O, TSF90F-O

INSIDE CORNERS

MODEL NUMBERS (TS SERIES)	TS05F-I	TS10F-I	TS15F-I	TS20F-I	TS25F-I	TS30F-I	TS45F-I	TS60F-I	TS75F-I
MODEL NUMBERS (TSF SERIES)	TSF05F-I	TSF10F-I	TSF15F-I	TSF20F-I	TSF25F-I	TSF30F-I	TSF45F-I	N/A	N/A
DESCRIPTION	5° Clip	10° Clip	15° Clip	20° Clip	25° Clip	30° Clip	45° Clip	60° Clip	75° Clip
SHIPPING WEIGHT Lbs. (kg.)	4 (2)	5 (2)	6 (3)	7 (3)	8 (4)	10 (5)	12 (5)	14 (6)	16 (7)
GENERAL PARTS	Stainless steel								
BACKSPLASH	Stainless steel 6" high (4" high optional) with 1" return at top, mechanically fastened and sealed								

INSIDE 90° CORNERS

MODEL NUMBERS (TS SERIES)	TS90F-FI	TS90F-I
MODEL NUMBERS (TSF SERIES)	TSF90F-FI	TSF90F-I
DESCRIPTION	90° Full	90° Clip
SHIPPING WEIGHT Lbs. (kg.)	20 (9)	18 (8)
GENERAL PARTS	Stainless steel	
BACKSPLASH	Stainless steel 6" high (4" high optional) with 1" return at top, mechanically fastened and sealed	

OUTSIDE CORNERS

MODEL NUMBERS (TS SERIES)	TS15F-O	TS20F-O	TS25F-O	TS30F-O	TS45F-O	TS60F-O	TS90F-O
MODEL NUMBERS (TSF SERIES)	TSF15F-O	TSF20F-O	TSF25F-O	TSF30F-O	TSF45F-O	N/A	TSF90F-O
DESCRIPTION	15° Clip	20° Clip	25° Clip	30° Clip	45° Clip	60° Full	90° Full
SHIPPING WEIGHT Lbs. (kg.)	6 (3)	7 (3)	8 (4)	10 (5)	12 (5)	14 (6)	20 (9)
GENERAL PARTS	Stainless steel						
BACKSPLASH	Stainless steel 6" high (4" high optional) with 1" return at top, mechanically fastened and sealed						



UNDERBAR CORNER SECTIONS
Angled Corners with Flat Tops

MODEL NUMBERS - TS05F-I, TSF05F-I, TS10F-I, TSF10F-I, TS15F-I, TSF15F-I, TS20F-I, TSF20F-I, TS25F-I, TSF25F-I, TS30F-I, TSF30F-I, TS45F-I, TSF45F-I, TS60F-I, TS75F-I, TS90F-I, TSF90F-I, TS90F-I, TSF90F-I, TS15F-O, TSF15F-O, TS20F-O, TSF20F-O, TS25F-O, TSF25F-O, TS30F-O, TSF30F-O, TS45F-O, TSF45F-O, TS60F-O, TS75F-O, TS90F-O, TSF90F-O

INSIDE CORNERS

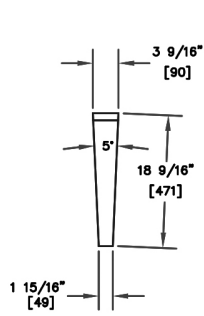

TS05F-I

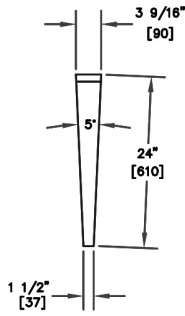

TSF05F-I

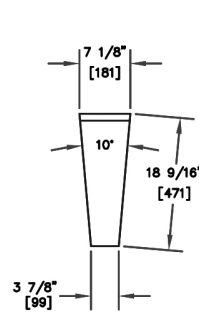

TS10F-I

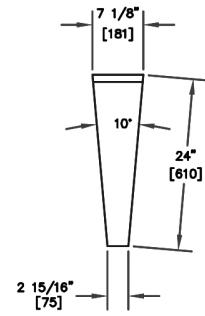

TSF10F-I

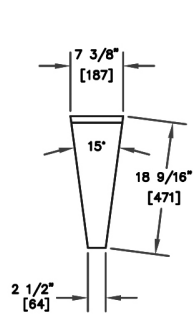

TS15F-I

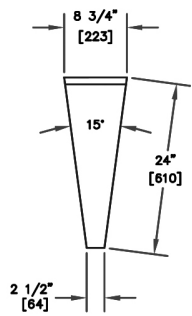

TSF15F-I

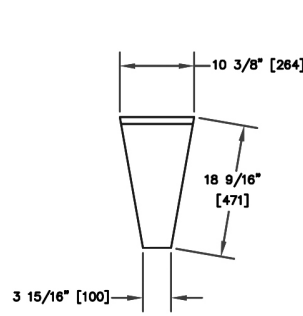

TS20F-I

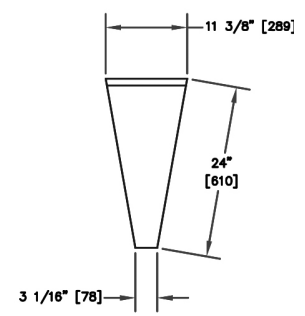

TSF20F-I

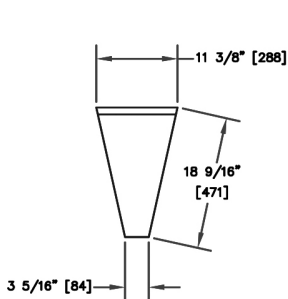

TS25F-I

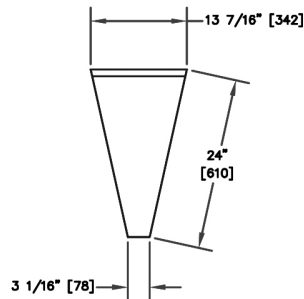

TSF25F-I

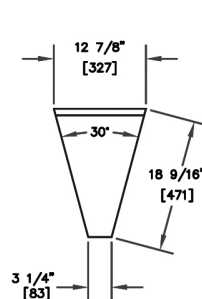

TS30F-I

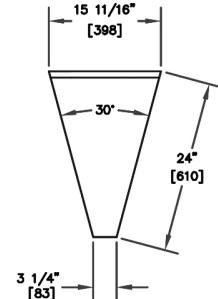

TSF30F-I

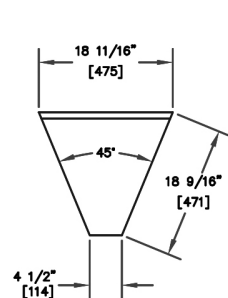

TS45F-I

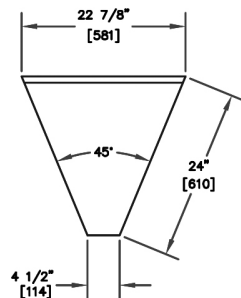

TSF45F-I

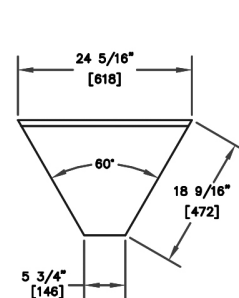

TS60F-I

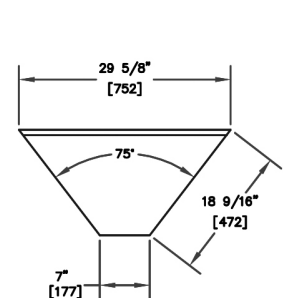

TS75F-I



UNDERBAR CORNER SECTIONS
Angled Corners with Flat Tops

MODEL NUMBERS - TS05F-I, TSF05F-I, TS10F-I, TSF10F-I, TS15F-I, TSF15F-I, TS20F-I, TSF20F-I, TS25F-I, TSF25F-I, TS30F-I, TSF30F-I, TS45F-I, TSF45F-I, TS60F-I, TSF60F-I, TS75F-I, TSF75F-I, TS90F-I, TSF90F-I, TS15F-O, TSF15F-O, TS20F-O, TSF20F-O, TS25F-O, TSF25F-O, TS30F-O, TSF30F-O, TS45F-O, TSF45F-O, TS60F-O, TSF60F-O, TS75F-O, TSF75F-O, TS90F-O, TSF90F-O

INSIDE 90° CORNERS

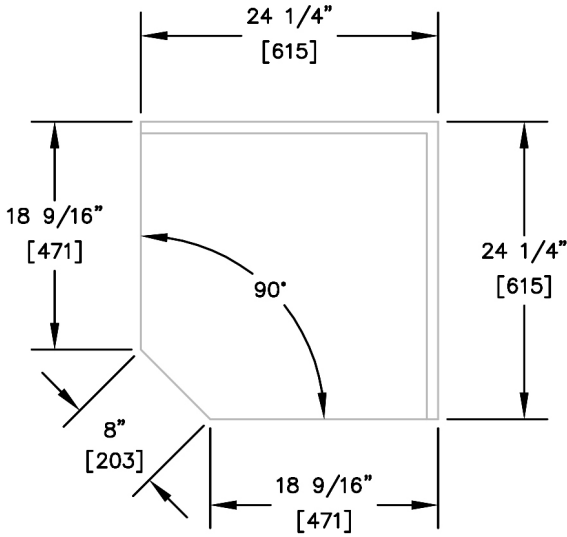

TS90F-FI

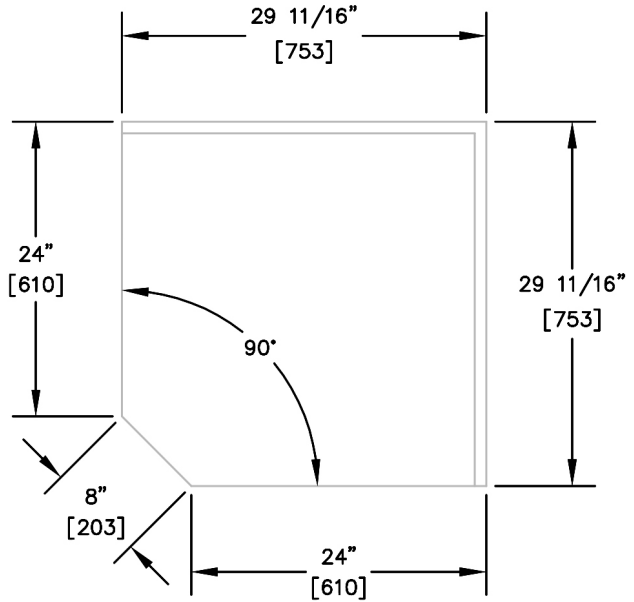

TSF90F-FI

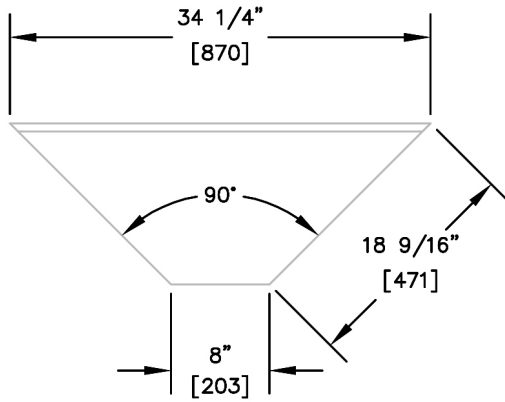

TS90F-I

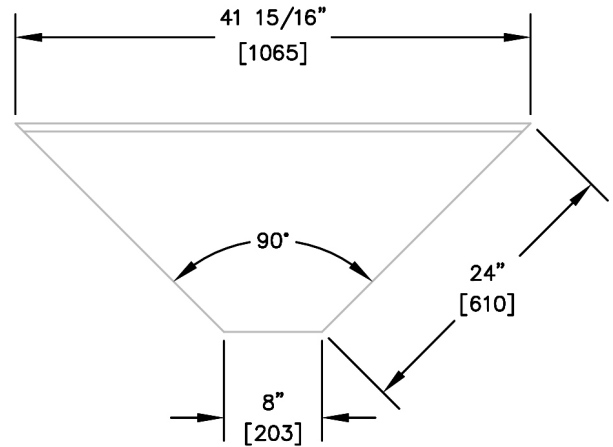

TSF90F-I



UNDERBAR CORNER SECTIONS
Angled Corners with Flat Tops

MODEL NUMBERS - TS05F-1, TSF05F-1, TS10F-1, TSF10F-1, TS15F-1, TSF15F-1, TS20F-1, TSF20F-1, TS25F-1, TSF25F-1, TS30F-1, TSF30F-1, TS45F-1, TSF45F-1, TS60F-1, TSF60F-1, TS75F-1, TSF75F-1, TS90F-1, TSF90F-1, TS15F-O, TSF15F-O, TS20F-O, TSF20F-O, TS25F-O, TSF25F-O, TS30F-O, TSF30F-O, TS45F-O, TSF45F-O, TS60F-O, TSF60F-O, TS75F-O, TSF75F-O, TS90F-O, TSF90F-O

OUTSIDE CORNERS

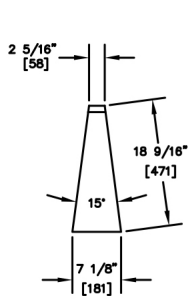

TS15F-O

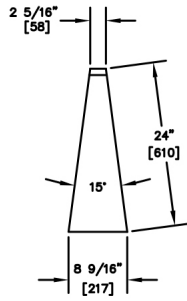

TSF15F-O

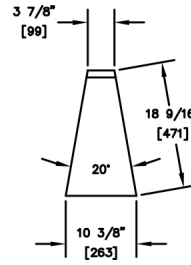

TS20F-O

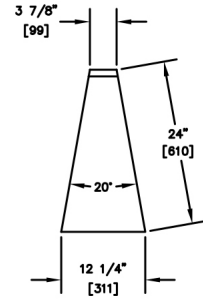

TSF20F-O

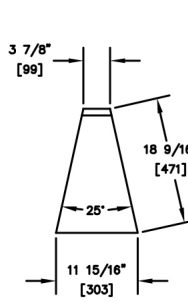

TS25F-O

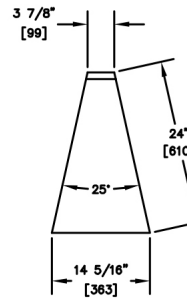

TSF25F-O

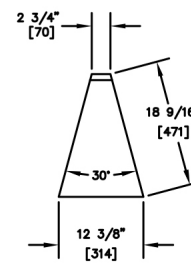

TS30F-O

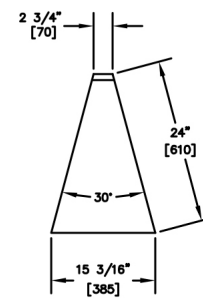

TSF30F-O

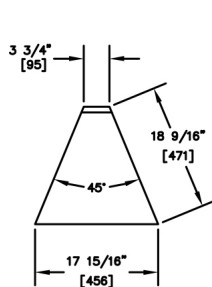

TS45F-O

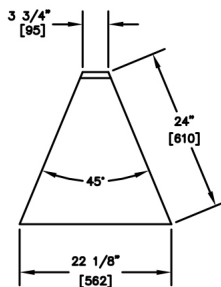

TSF45F-O

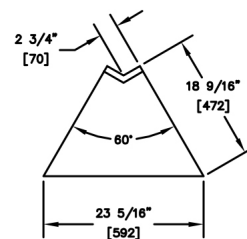

TS60F-O

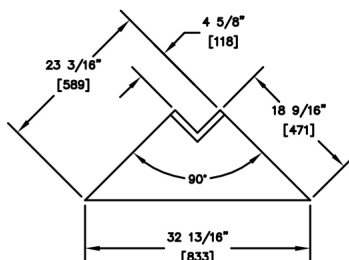

TS90F-O

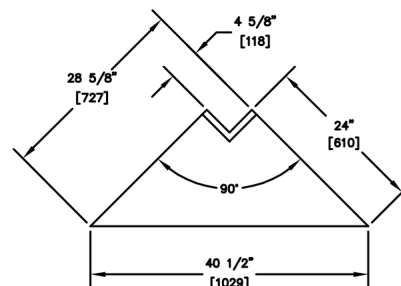

TSF90F-O