



# T&S BRASS AND BRONZE WORKS, INC.

2 Saddleback Cove / P.O. Box 1088  
Travelers Rest, SC 29690

Model No.

**B-7102-08M**

Item No.

Travelers Rest, SC: 800-476-4103 • Simi Valley, CA: 800-423-0150 • Fax: 864-834-3518 • www.tsbrass.com

This Space for Architect/Engineer Approval

Job Name \_\_\_\_\_ Date \_\_\_\_\_

Model Specified \_\_\_\_\_ Quantity \_\_\_\_\_

Customer/Wholesaler \_\_\_\_\_

Contractor \_\_\_\_\_

Architect/Engineer \_\_\_\_\_



Wall Mount,  
Hose Out

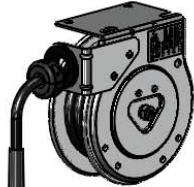

Under Counter,  
Hose Out



Wall Mount,  
Hose Down

or  
Under Counter,  
Hose Down  
(Default Configuration)

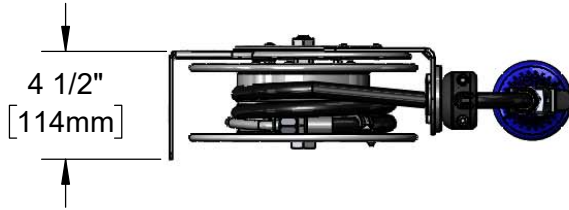

4 1/2"  
[114mm]

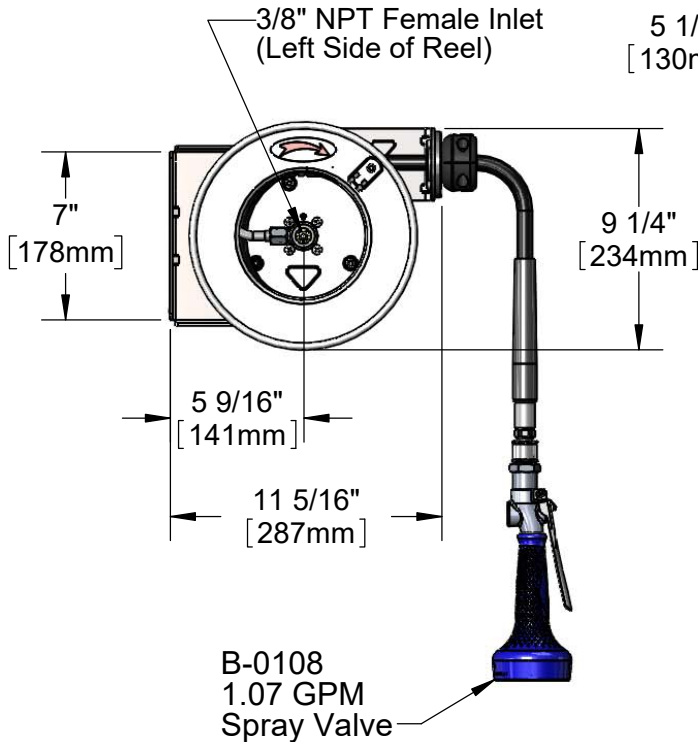

3/8" NPT Female Inlet  
(Left Side of Reel)

5 1/8"  
[130mm]

7"  
[178mm]

9 1/4"  
[234mm]

5 9/16"  
[141mm]

11 5/16"  
[287mm]

B-0108  
1.07 GPM  
Spray Valve

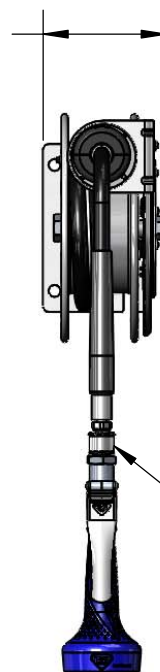

019652-40  
3/8" NPT  
Live Swivel

Ø 1/2"  
[13mm]

Mounting Hole  
Details

5 1/4"  
[133mm]

3 1/8"  
[79mm]

**Product Specifications:**

3/8" x 12 Ft. Open Stainless Steel Reel w/ 1.07 GPM Spray Valve & Swivel

**Product Compliance:**

NSF 61 Exempt (Non-Potable)  
EPA Act 2005 (PRSV)



**T&S BRASS AND BRONZE WORKS, INC.**  
 2 Saddleback Cove / P.O. Box 1088  
 Travelers Rest, SC 29690

Model No.  
**B-7102-08M**

Item No.

Travelers Rest, SC: 800-476-4103 • Simi Valley, CA: 800-423-0150 • Fax: 864-834-3518 • www.tsbrass.com

ITEM NO.	SALES NO.	DESCRIPTION
1	B-0108	1.07 GPM Spray Valve
2	001014-45	Washer
3	016154-25	B-0108 3/8" NPT Hose Adapter
4	017938-45	3/8" x 12 Ft. Hose Replacement Kit
5	019246-45	Hose Stop Repair Kit
6	017355-45	Swivel Repair Kit
7	014948-45	O-Ring Replacement Kit
8	017352-45	Guide Bushing Kit
9	017362-45	Spring Assembly
10	017359-45	Ratchet Lever Kit
11	019652-40	3/8" NPT Live Swivel



Product Specifications:  
 3/8" x 12 Ft. Open Stainless Steel Reel w/ 1.07 GPM Spray Valve & Swivel

Product Compliance:  
 NSF 61 Exempt (Non-Potable)  
 EPA Act 2005 (PRSV)