

# SNOW ICE MAKER USER MANUAL

## MODEL : IS-0700-AS

---

- ※ This machine cannot be used in any other country where the electric voltage for its power supply is not available.
- ※ This product is designed for indoor installation.  
Please be sure to install it indoors.
- ※ The external appearance, design, color, and/or components of this machine may be changed without prior notice for the sake of the Company's product manufacture.
- ※ For maximum hygiene, be sure to clean and sterilize the product on a daily basis.

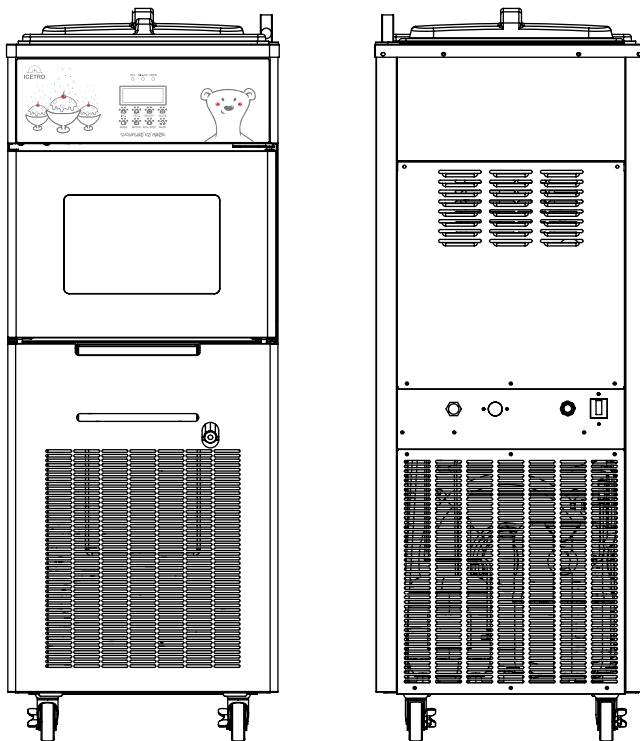



# INDEX

---

1. Preparations for safety .....	3~7
2. Installation and other information .....	8
3. How to install .....	9~14
4. Part names .....	15~16
5. Specification .....	17
6. Operation specifications and how to use .....	18~24
7. How to wash	
– Disassembling and washing .....	25~26
– Sterilizing and second washing .....	27~29
– Washing and cleaning .....	30

# 1. Preparations for safety

 <b>Warning</b>	Failure to follow these instructions may result in severe personal injury or death.
 <b>Caution</b>	Failure to follow these instructions may result in parts replacement expense and / or service repair expense.



SHOULD BE DONE



PROHIBITION



DO NOT  
DISASSEMBLE



DO NOT  
TOUCH



DISCONNECT  
POWER PLUG



GROUNDED

## Warning

Use a single receptacle for the ice machine.

- ◆ An electrical fire may be caused by a receptacle holding more than one item.
- ◆ Do not use an adapter or an extension cord.

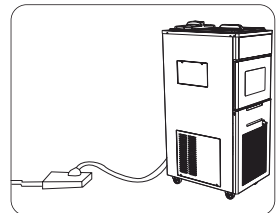

Clean the plug

Clean the plug, if covered in foreign material or dust etc. with a clean, dry towel.

- ◆ A fire may occur if plug is not clean.

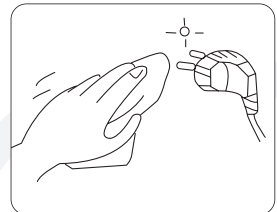



## Warning

**Do not place or store heavy items on the top of the product.**

- ◆ Damage by excessive weight can cause the unit to overheat and/or fire.

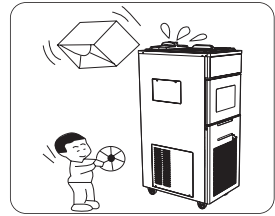

**Do not install the machine under humidity area or near the area where water could spatter.**

- ◆ Lack of insulation causes an electric leakage, shock and fire.

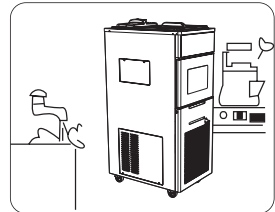

**Stop operation**

**When the smell of burning or smoke is emitted from the machine, or if the product malfunctions, immediately unplug the product and stop operation.**

- ◆ Operating the product under bad conditions may cause fire or electric shock.

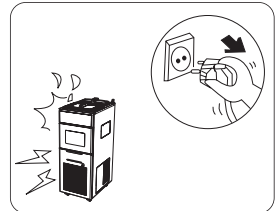

**Prohibition of use:**

**Do not use flammable gas near the icemaker.**

- ◆ It may cause explosion and fire.

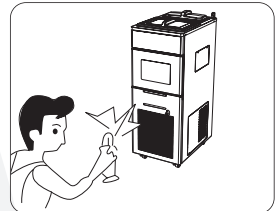

**Prohibition of use:**

**Replace or tighten the receptacle if it is loose.**

- ◆ An electric short or fire can occur.

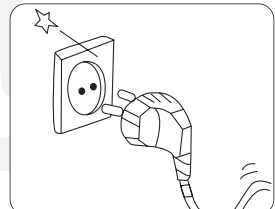



## Warning

**Do not disassemble**

**Do not modify the parts of icemaker, and repair without an authorized person**

- ◆ It may cause the fire or extraordinary operation, and would result in the serious problem.

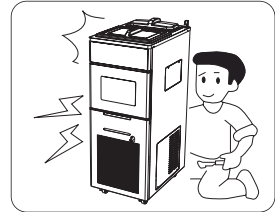

**Prohibition**

**Do not bend the power cord severely, or allow it to be pressed by a heavy matter, which can cause damage to the cord.**

- ◆ There is a danger of a current leak, electric shock and/or fire
- ◆ Be sure to contact the customer service center if the power cord or plug gets peeled or damaged.

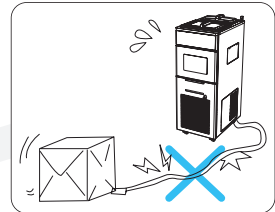

**Prohibition**

**Do not let children hang on the door of the icemaker.**

- ◆ Injury to the child or damage to the icemaker may occur.
- ◆ Let them avoid hanging onto the front door of the model when it is open.

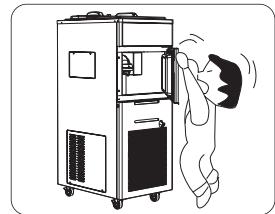

**Do not touch**

**Do not touch or disconnect the power cord with wet hands.**

- ◆ It may cause an electric shock.

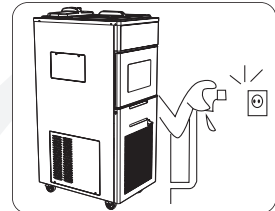

**Do not touch**

**Do not clean the inside the ice maker with sharp tools.**

- ◆ It may cause the damage of colling system ice storage part or electrocution.

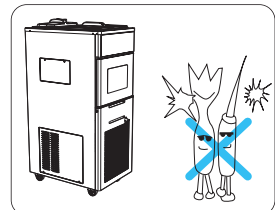



## Warning

### Disconnect power plug

For long term usage interruption or product shut-down, close the water supply valve, remove the ice from the product and unplug the power cord.

### Disconnect power plug

Unplug the power cord first when cleaning or servicing.

◆ It may cause electric shock, fire, or injury.

### Disconnect power plug

Separate the power plug from the receptacle with holding the plug body.

◆ Pulling the power cord or using a screwdriver to unplug may cause fire or electric sparks.

### Grounded

The Ice Machine must be connected to a GFCI receptacle or a GFCI circuit

◆ An ungrounded circuit may cause product failure or an electric shock.

### Power strip use

Make sure the power strip supports higher power than 250V and 16A.

◆ Using multiple appliances on one power strip may cause fire. Thus, be sure to plug only one appliance especially when using this product.

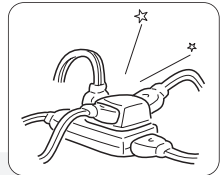
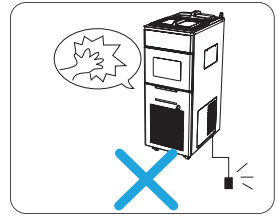
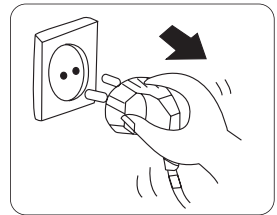
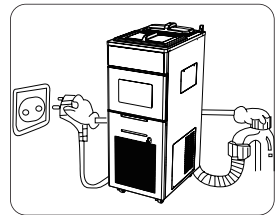
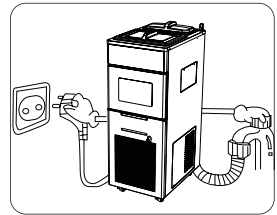



## Caution

### Caution

Remove any moisture oil, anything that may cause slipping on the ground near the product.

- ◆ Slipping and hitting the ice maker or sticking one's hand or foot into the bottom will cause injury.

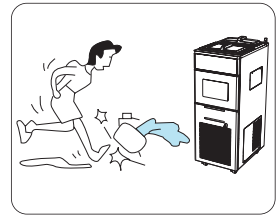

### Hand over

As you turn over the icemaker to the other user, please turn over the operation manual together.

- ◆ Be sure to refer to the user manual for the safest usage by users who are not familiar with the product.

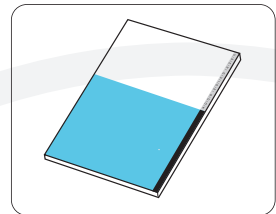

Do not slide hands or feet in under the icemaker.

- ◆ The bottom of this product has various parts including metal sheet, which may cause injury.

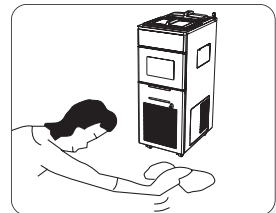

When reconnecting the power cord after disconnection, wait at least 5 minutes before reconnecting.

- ◆ Plugging in right away may cause overload and malfunction.

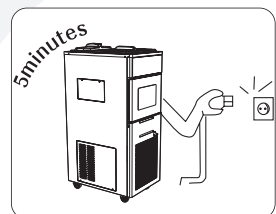

This product senses ice with voltage (resistance); since ice made of distilled water may not be recognized, tap water is highly recommended.

## 2. Installation and other information

Be sure to fix the product securely as in the figure at your preferred location. Otherwise, the manufacturer is not liable for any incident or injury resulting from the fall of the product while in use.

### 〈 Fixing the product 〉

1. Check the break on the bottom wheel.

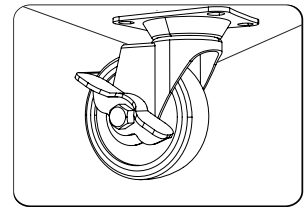

2. Secure the product and rotate the break clockwise. The product will not budge if the break is working fine. Turn the break counterclockwise to move the product.

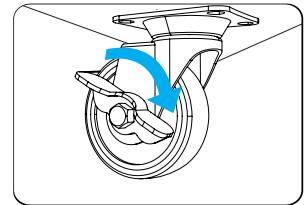

[ To fix on the surface ]

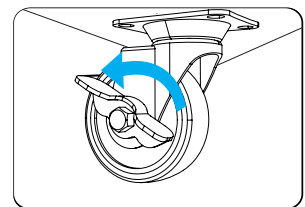

[ To move the product ]



# 3. How to install

1. In the rightmost part of the back of the product is the power line, which can be connected to a power source.

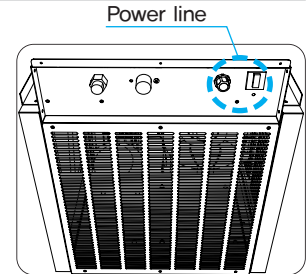

2. Fully tighten the socket on the water supply part at the back before connecting the water hose.

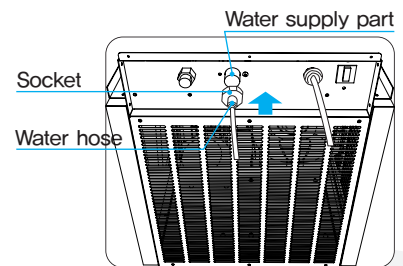

3. In the leftmost part of the back of the product is the water supply line for washing the product.

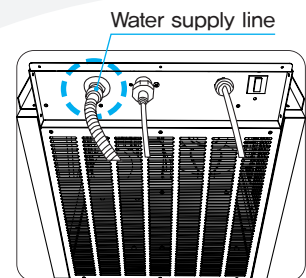

4. This product has a separate water supply line at the front, which is not embedded and can be opened or closed anytime for cleaning. (The drain plug has to be in place normally.)

◆ If necessary, a drain hose can be connected, and you can plug the end of the drain hose.

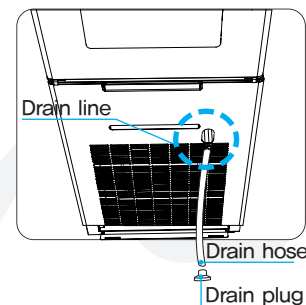

⚠ **Caution** : If having trouble with the flow of raw material after long pause of use, the milk supply hose could have been adhered. Please press the button 'VALVE' to operate the pinch valve (OPEN) and move the hose from side to side to release the adhesion.

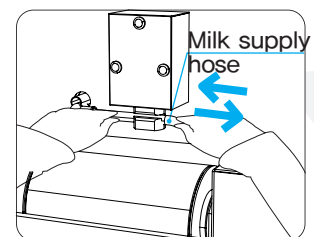

# 3. How to install

## Suitable installation condition and place

● Places without heat sources

- ◆ The product has to be installed at places without a heat source such as stove or gas range or any place that is out of the range of the ambient temperature (10 ~ 38°C, 50~100°F).

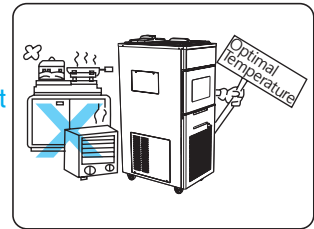

● Places with enough spaces from the walls

- ◆ The minimum distance required is 20cm(8") from the walls for normal operation.

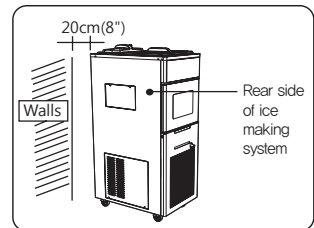

● Places with good ventilation

- ◆ Inadequate ventilation will lead to poor ice-making capability

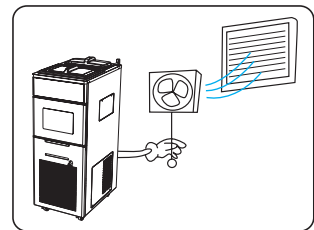

● On even surfaces

- ◆ Uneven surface will result in too much vibration or noise. (The surface angle must be less than 1 ° )
- ◆ Installing the product on an uneven surface may cause it to fall or slip and cause injury. Make sure that the product is installed on an even surface.

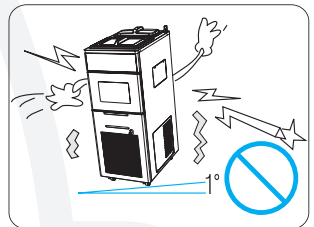

- ▲ Caution : When installed on an uneven surface, the ingredient in the drum gutter may overflow.

# 3. How to install

## Suitable installation condition and place

- Be sure to install the product in clean places.
  - ◆ Ice will be used for food or human consumption.  
Thus, the installation site must be clean and hygienic.

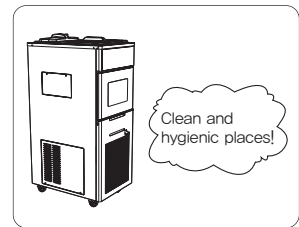

- The product must be installed and used indoors.
  - ◆ A drain hose must be inserted from the front for the best draining result.
  - ◆ Be sure to put back the drain plug when the drain hose is not in use.
  - ◆ Use a basket of the appropriate size to dispose of the drained water.

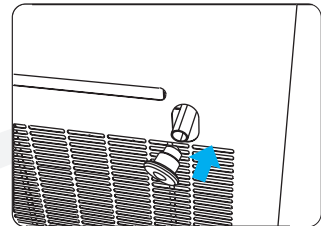

- In a place inaccessible to children.
  - ◆ Please pay proper attention to the safety of children; make sure that no one plays with the blade of the ice making part.

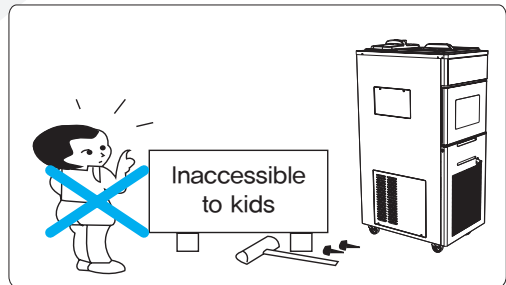

**Warning**

- ◆ Make sure to observe the following.
  - The product uses of water or dairy product; thus, proper water supply and draining facility are required at the installation site.
  - Water may leak during installation or operation for various reasons, so proper draining must be prepared. Since there is danger of electric shock from the moisture from leak, be sure to observe the following:
    1. When installing the product indoors, be sure to have a natural drainage facility and make the floor waterproof, especially if the floor may be damaged from leak.
    2. There must be a draining outlet even when installing in a kitchen, be sure to connect the drain hose.
    3. Make sure that the floor is sloped so that the leaking water can get drained away even if the drain, water supply hose get dislodged or damaged. Install a water overflow prevention wall to prevent damage.
- ※ The manufacturer will not be liable for any issue arising from noncompliance with the abovementioned warnings, dislodged / damaged water supply hose, or inappropriate drain facility.

# 3. How to install

## After installation

### ● Protection of the water supply hose

Do not put any heavy object on the water supply hose. Do not step on it either.

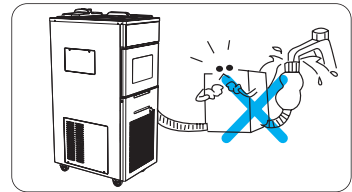

### ● Optimal water pressure, water temperature, or ambient temperature.

This ice maker must be used under conditions of water pressure of 1~5kg/cm<sup>2</sup>(20~80psi), water supply of 10~32°C(50~90°F), and ambient temperature of 10~38°C(50~100°F)

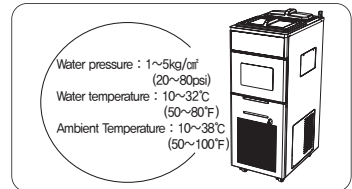

**Connect potable water supply only.**

#### 1. Plugging into the power supply.

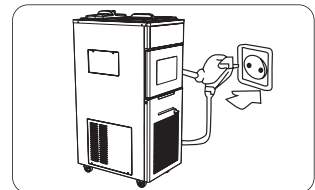

#### 2. Supplying water to the Ice maker.

- ◆ Open the faucet to supply water to the icemaker.

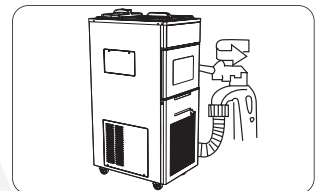

#### 3. Ice making

- ◆ Turn on the power switch on the front display panel to start ice making.

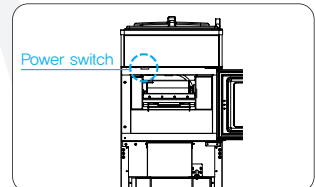

#### 4. Ice Making Operation.

- ◆ Ice making starts within 1 minute of commencement of operation ; it takes about one hour to fill the ice basket completely. Note, however, that the time to make ice varies depending on the ambient temperature as well as how cold the water is.

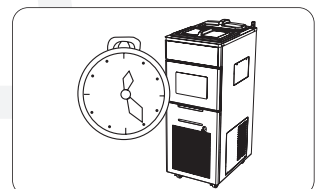

# 3. How to install

## About grounding

※ Be sure to ground the product to prevent electric shock.

⦿ **Grounding method – When there is a grounding terminal**

In case of plugging the icemaker into a power outlet equipped with a grounding terminal, extra grounding is unnecessary.

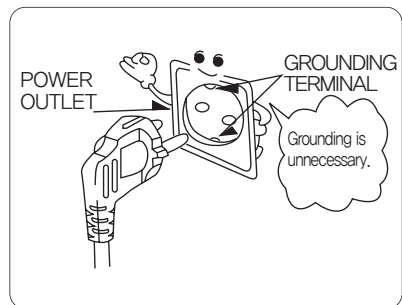

⦿ **Grounding method – When there is no grounding terminal**

In case of plugging the icemaker into a power outlet without a grounding terminal, connect the ground wire to the copper plate and then bury it under the ground.

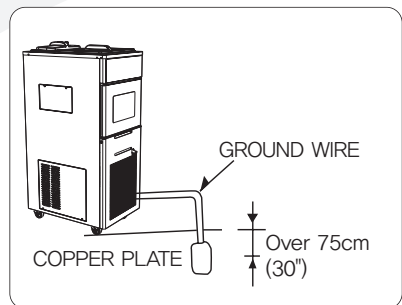

**Do not ground the product on the following:**

**Gas piping, water supply, lightning rod, telephone line, or any connection part**

※ Plastic water piping or non-insulated material will not provide a grounding effect.

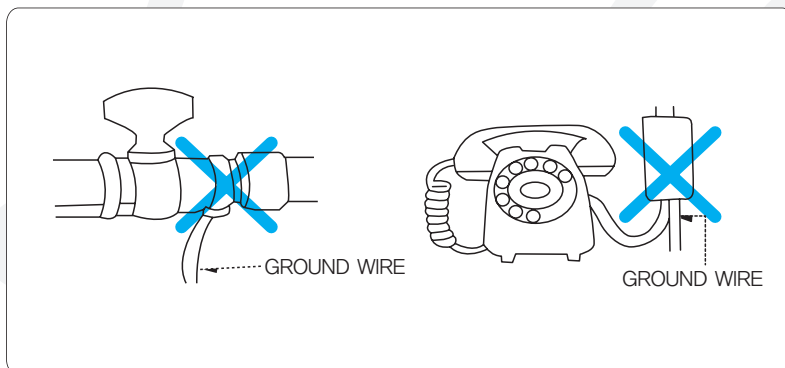

# 3. How to Install

## How to install tray holder

### STEP 1.

Remove the front cover by inserting the fingers into the holes on the right and the left.

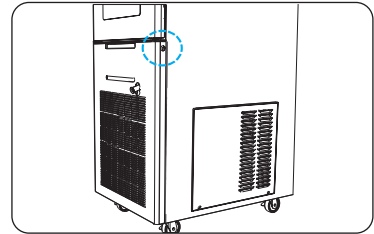

### STEP 2.

Pull the tray holder to the front and close the front cover again until the top of the cover is fully attached.

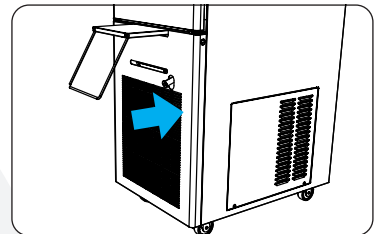
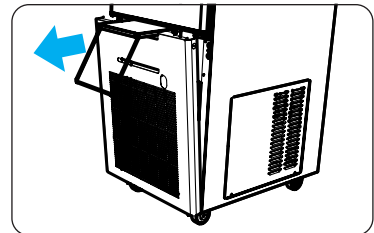

### STEP 3.

Insert the support of the tray holder in the right place.

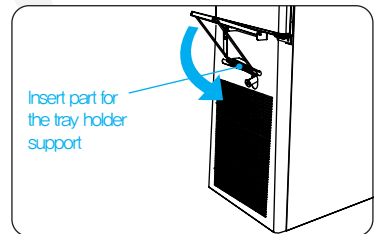

### STEP 4.

If it is not to be used, insert in reverse order.

- ◆ Caution : Do not put anything weighing more than 5kg on the tray; never let anyone sit on it.
- ◆ Caution : Use caution to avoid getting caught in the extruding part of the tray holder.

# 4. Part names

## Top

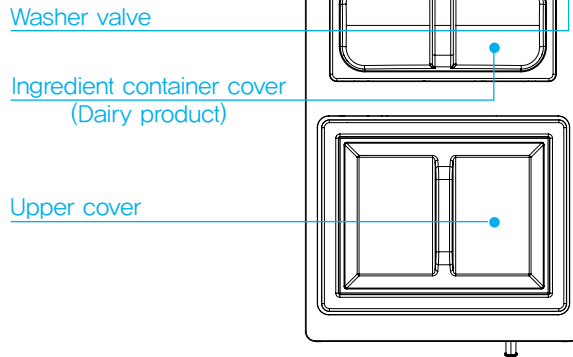

## Front

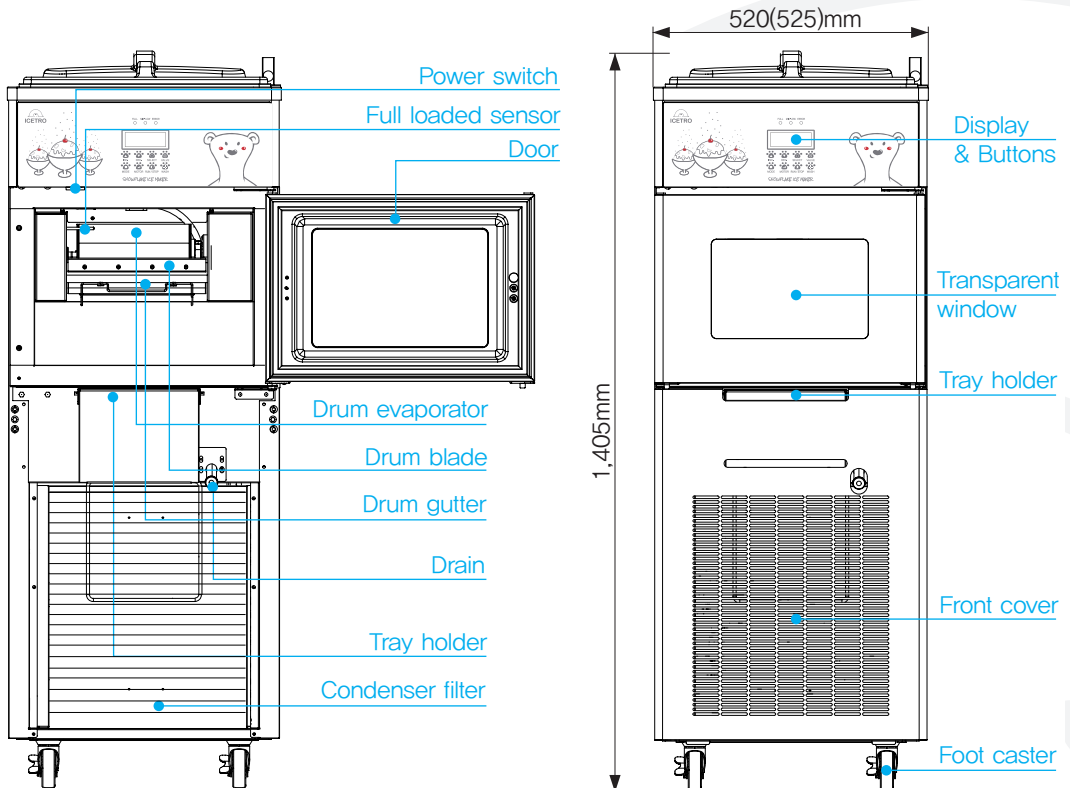

# 4. Part names

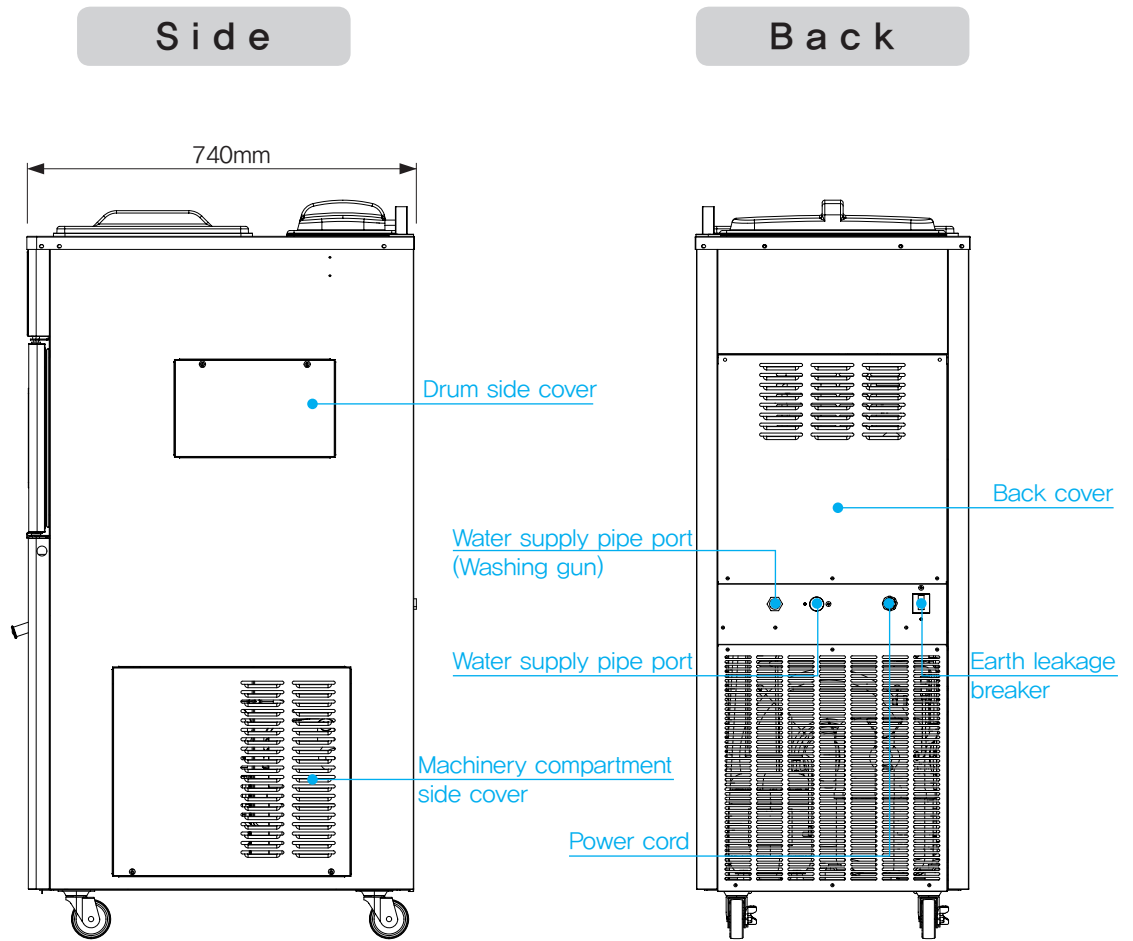



## 5. Specification

Category	Specification	
Model	IS-0700-AS	
Ice making capacity	Water : 320kg(705.5Lbs)/day	Milk : 500kg(1102.3Lbs)/day
Size (W X H X D)	520 X 740 X 1,405 mm (20.5" X 29" X 55.3")	
Weight	140kg(309Lbs)	
Door	Tight PVC foam integration for insulation	
Compressor	Freezing(Drum) 1, 1/2 Hp	Cold storage(Bin, Hopper) 1/4 Hp
Cooler	Freezing : Drum revolution type	Cold storage : Tube sensor-based direct cooling
Condenser	Fan-based forced air cooling	
Power	AC 220~230V 60Hz / 1PH	
Operation temperature	Freezing : -25°C ~ -35°C (-10°F ~ -31°F)	Cold storage : 10°C(50°F) or lower
Drum rev count	* Water : 1200rpm	* Milk : 950(750)rpm
	500 ~ 1500(1300)rpm	
Accessories	Cleaning brush (2 types), Washing gun, Drain hose and plug(2EA), Water supply socket and scoop, Wrench for adjusting blade, Blade gap gauge (2 types), User manual	
Refrigerant	Freezer : R-404A	Cold storage : R-134a
Earth leakage breaker	optional	
Purpose	Snow ice machine	

\* Factory default values may vary per ingredient type or as per the customer's request.

**▲ Caution :** This product is intended for use with water or diluted milk; therefore, be sure to consult with the manufacturer if you need to use other ingredients. (Otherwise, the product may malfunction.)

## 6. Operation specifications and how to use

### STEP 1.

[ Milk / Water Mode ]

When turned on the machine, ingredient type can be selected.

Press INC/DEC to select either "Milk" or "Water", and then press SELECT to finish setup.

- ◆ Enough milk must be in the ingredient container before selecting milk mode.
- ⚠ Caution : If insoluble ingredient gets precipitated, be sure to stir the container every 20~30 minutes.

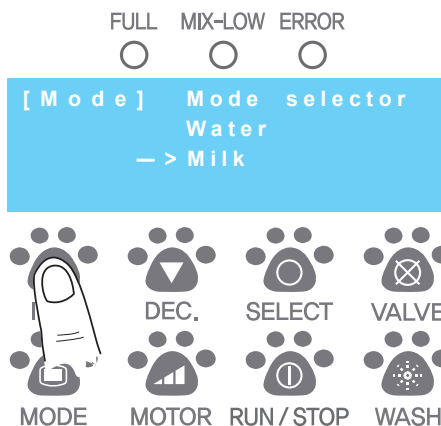

### STEP 2.

[ Operation Select ]

Press MODE once more to select either "Auto" (Auto operation) or "Timer"(Time setting operation).

- ◆ Auto : The machine operates automatically and continuously till the full loaded sensor detects snow ice.
- ◆ Timer : The drum will revolve as long as set on the "Timer Run Setting" (Refer to the STEP 7.) and generate snow ice.

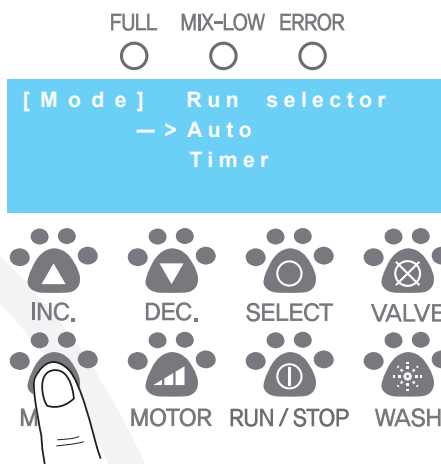

### STEP 3.

[ Temperature Display ]

Press MODE once more to see the present temperature of the hopper or the bin.

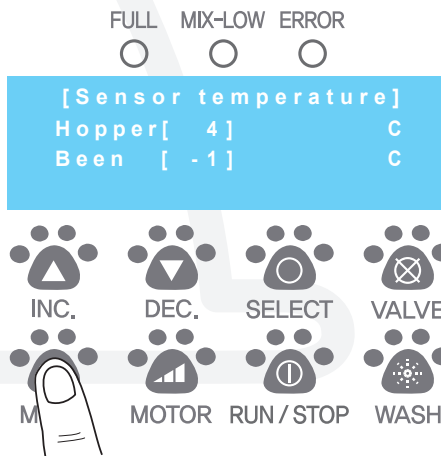

## 6. Operation specifications and how to use

### STEP 4.

[ Bin Temperature Setting ]

Press MODE once more to set the bin temperature.

Set the temperature by pressing INC/DEC buttons, and then press SELECT button to finish setup.

- ◆ On : The temperature that the compressor starts running.(Default setting value /Recommended setting value : 0°C)
- ◆ Off : The temperature that the compressor stops running.(Default setting value /Recommended setting value : -3°C)

⚠ Caution : The bin will keep the temperature from -3°C~0°C.

Setting the On and Off value too high or too low may cause ice to melt or to be a lump.

Please do not change the default setting value except when necessary.

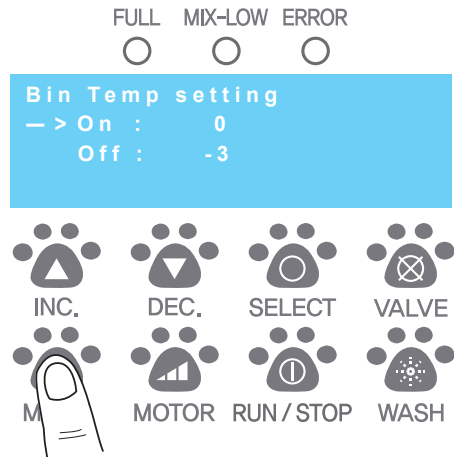

### STEP 5.

[ Mix Hopper Temperature Setting ]

Press MODE once more to set the mix hopper temperature.

Set the Temperature by pressing INC/DEC buttons, and then press SELECT button to finish setup.

- ◆ On : The temperature that the compressor starts running.(Default setting value /Recommended setting value 7°C)
- ◆ Off : The temperature that the compressor stops running.(Default setting value /Recommended setting value 4°C)

⚠ Caution : The mix will keep the temperature from 4°C~7°C.

Setting the On value too high may cause the ingredient(milk)

to be rotten and setting the Off value too low may cause the left ingredient to be frozen.

Please do not change the default setting value except when necessary.

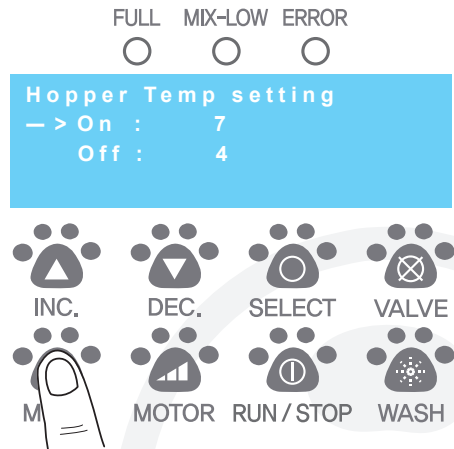

## 6. Operation specifications and how to use

### STEP 6.

[ Touch Button Sensitivity Adjust ]  
Press MODE once more to adjust the sensitivity of the touch button.

⚠ Caution : The default setting value is "1".  
Please do not change the default setting value except when necessary. ("1")

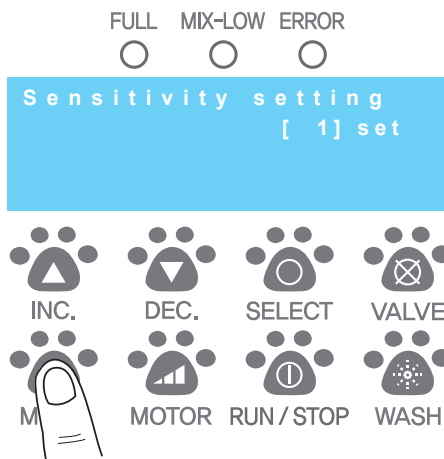

### STEP 7.

[ Operating Time Setting ]  
Press MODE once more to set the operating time. Finish the setup by pressing SELECT button after setting the time (Unit : Minutes) with INC/DEC buttons.

The set up operating time is only applicable on the "Timer" mode (STEP 2).  
Press RUN button on the "Timer" mode and the machine will be operating for as long as the setting time and will stop operation automatically when the time is up.

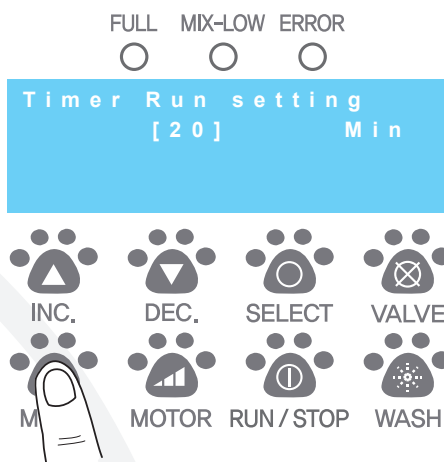

### STEP 8.

[ Error Display ]  
Press MODE once more and "NO ERROR" message will show up which means the machining is ready for normal operation.

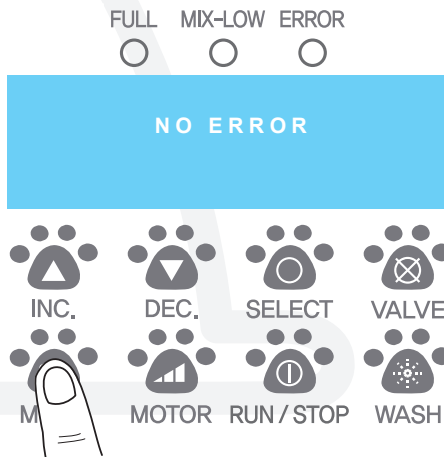

## 6. Operation specifications and how to use

### STEP 9.

[ Program Version Display ]

When you press the MODE button once again, you can check the current program version.

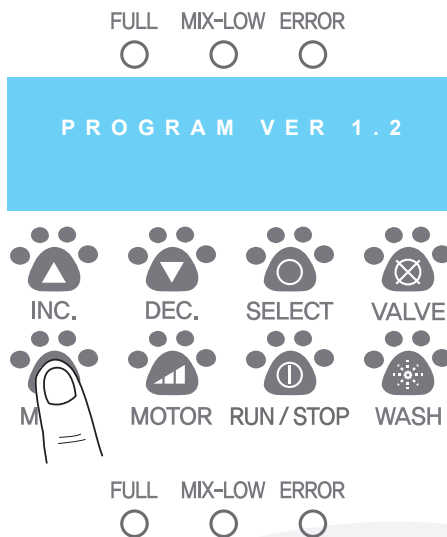

### STEP 10.

[ Factory Reset Setting ]

When you press the SELECT and VALVE buttons at the same time at STEP 9, all the setting value will be initialized. (It will be changed by the default setting of factory outgoing.)

**⚠ Caution :** Please note that the existed setting value will not be saved automatically.



### STEP 11.

[ Controlling motor speed ]

Press buttons in the order of MODE > MOTOR > INC. / DEC. to control the motor speed. Increasing the speed will make the motor run faster, and reducing the speed makes the motor run slower. (Speed can only be controlled while the product is in operation.)

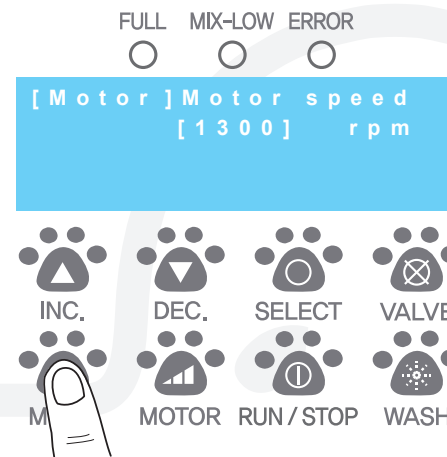

## 6. Operation specifications and how to use

### STEP 12.

[ Operating ]

Press RUN/STOP to start operating the product; snow will be made in about 60 seconds. (Lamp ON)

\* When on the "Timer" mode.

Operation complete time is shown together.

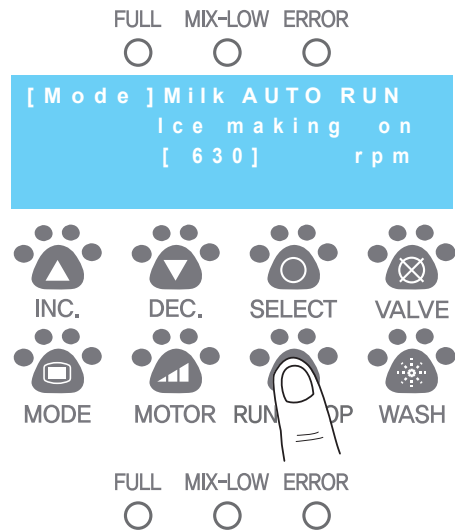

[ STOP ]

Press RUN/STOP once again to stop operation. (Lamp OFF)

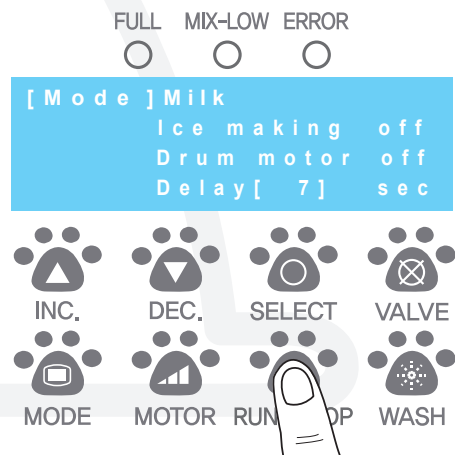

## 6. Operation specifications and how to use

### STEP 13.

[ Washing ]

In wash mode, only the drum will be running for 60 minutes. Use the washer and other tools to wash the product. Press WASH again to exit the wash mode.

- ◆ The cold storage function will be disabled in wash mode; use the function for washing purposes only.

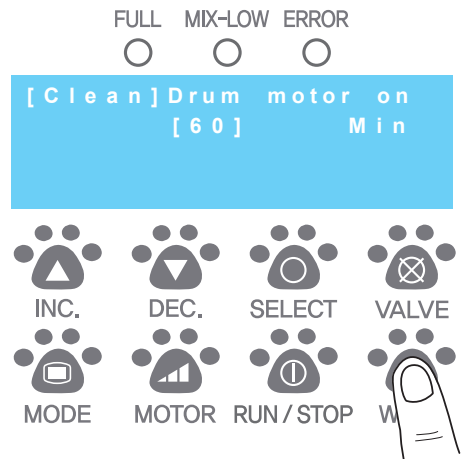

### STEP 14.

[ Pinch valve ON ]

Open the hose to supply milk; undiluted milk will be delivered to the drum gutter.

- Caution : Empty the drum gutter. If the level sensor detects the presence of the ingredient or water, the pinch valve will not be activated.

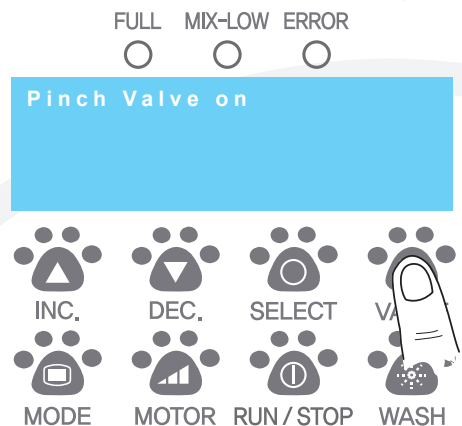

### STEP 15.

[ Pinch valve OFF ]

Plug milk supply hose to stop undiluted milk from running.

- ⚠ Caution : Empty the drum gutter. If the level sensor detects the presence of the ingredient or water, the pinch valve will not be activated.

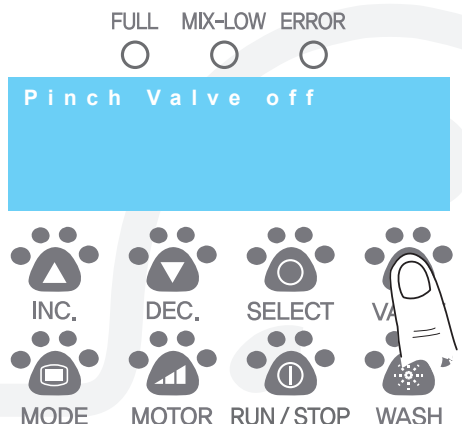

## 6. Operation specifications and how to use

### STEP 16.

[ FULL ]

Displayed when the storage tank is filled with snow ice.

The full loaded sensor in the tank will detect the level; when the FULL lamp is on, the product will stop. Remove snow ice from the tank and press RUN to resume operation.

FULL MIX-LOW ERROR



[Err]Milk sold out  
[100]Mix out

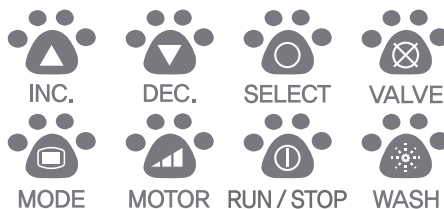

### STEP 17.

[ MIX-LOW ]

Yellow LED will blink if the ingredient tank does not have enough ingredient. Fill the tank with ingredient.

[ MIX-OUT ]

In MIX-LOW state, if not filled with more ingredient, the yellow LED will be on and the buzzer will go off for 1 second every 10 seconds. Fill the tank with ingredient. Otherwise, ERROR will be displayed.

FULL MIX-LOW ERROR



[Err]Milk sold out  
[100]Mix out



### STEP 18.

[ ERROR ]

Lit when the drum gutter does not have ingredient (Freezing stops)

Also lit when the sensor malfunctions or high pressure error occurs

FULL MIX-LOW ERROR



[Err]Milk sold out  
[100]Mix out

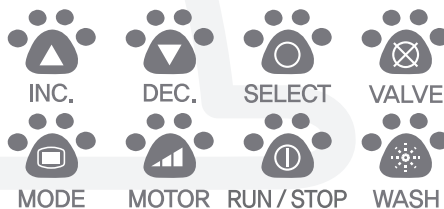

- ◆ When ERROR is lit, the issue has to be resolved, and the product has to be rebooted.





## 7. How to wash – Disassembling and washing

### STEP 5.

Disassemble the milk supply hose and its joint. (After disassembling the hose, press "VALVE" button at the front to enable "Pinch Valve ON," and then remove the hose.)

**▲ Caution :** Drum gutter has to be removed first.

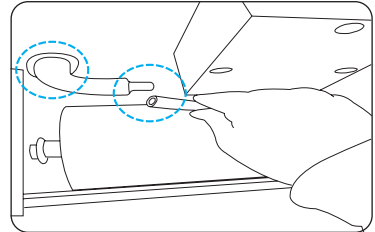

### STEP 6.

Remove water supply fittings.

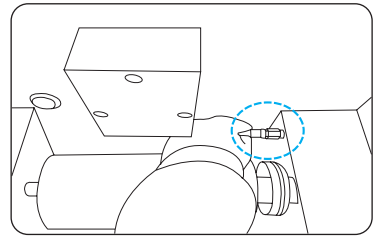

### STEP 7.

Remove the drain board from the inside of the storage tank.

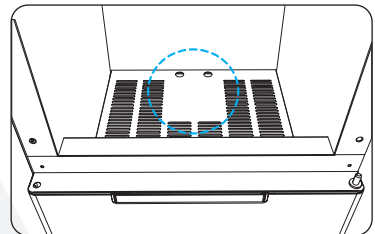

### STEP 8.

Remove the rubber seal of the door.

Door rubber seal

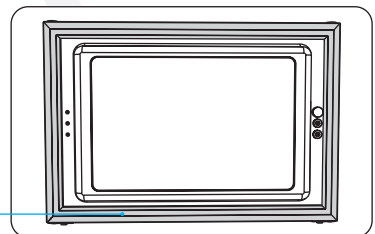

## 7. How to wash – Sterilizing and second washing

### STEP 1.

▲ **Warning** : Washing the blade can pose danger, so be sure to wear protective gloves first.  
Sterilize the removed blade and rubber seals first.

### [ Parts to disassemble and wash ]

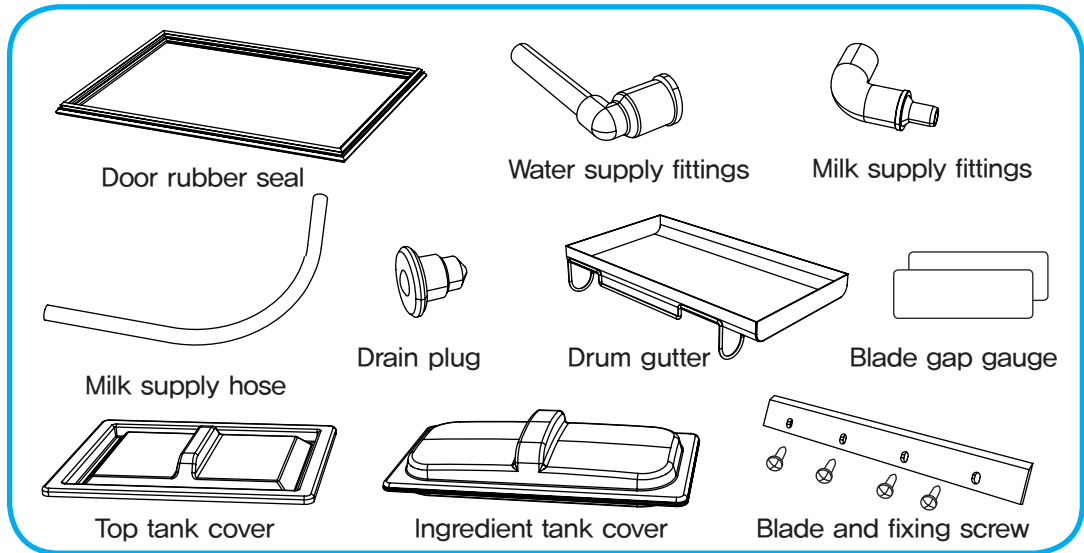

### [ Sterilizing rubber parts ]

Apply cleaning agents in lukewarm water minimizing bubbles. Hot water must NOT be used since it can damage or cause the sagging of rubber parts.  
Be sure to dry the washed parts completely.

### STEP 2.

Clean the inside of the ingredient tank, machinery compartment, and the inside of the storage tank with cleaning agent and running water.

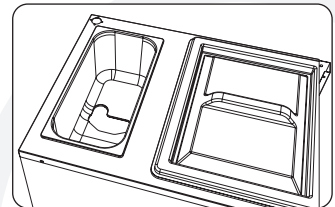

### STEP 3.

Clean the ingredient inlet and outlet of the storage tank thoroughly with cleaning brush.

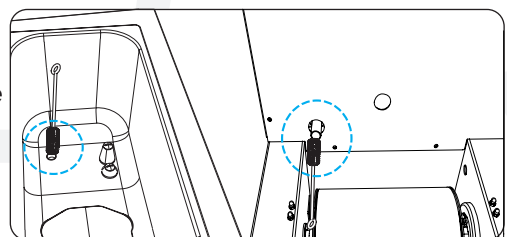

## 7. How to wash – Sterilizing and second washing

### STEP 4.

Clean the front drain hose with cleaning brushes.

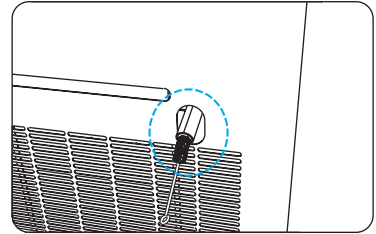

### STEP 5.

Assemble the cleaned parts and rubber seals in reverse order.  
Be sure to assemble the drain plug together.

### STEP 6.

Adjust the blade after assembling all of the cleaned parts.(Use the #10 wrench included in the package.)

- ① Set the blade in position and tighten the bolt a bit.
- ② Insert the gap gauge between the drum and the blade and tighten both bolts on each side a bit more.  
(Water : 0.5mm gauge, Milk : 0.8 mm gauge)
- ③ When the blade is secured, remove the gap gauge and fully tighten the bolts.

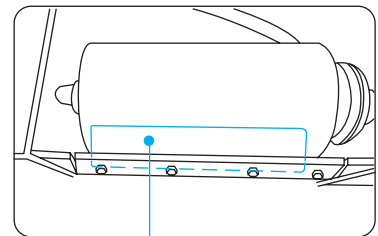

Blade gap gauge

### STEP 7.

Pour sanitizer (K5, separately available) in the water basket to dilute it.

- ◆ How to dilute : One bag of sanitizer is good with 10 liters(2.64 gal) of water.

## 7. How to wash – Sterilizing and second washing

### STEP 8.

Pour diluted sanitizer into the hopper basket and water gutter, and then press WASH to start operating of the drum, so that the diluted sanitizer coats the entire drum evenly. (Run for 1 minute.)

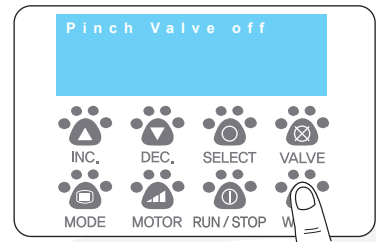
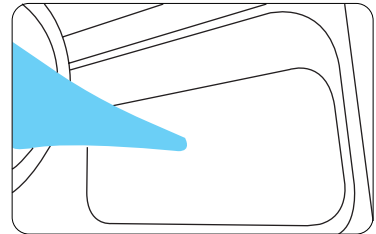

### STEP 9.

Fill the diluted sanitizer into the water gutter and press the "WASH" button. Press the "WASH" button again after 1 minute to stop the drum.

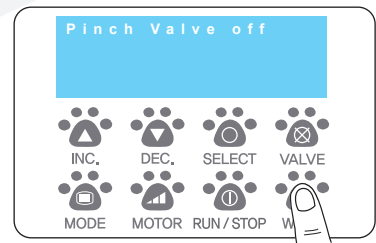

## 7. How to wash – Washing and cleaning

### STEP 10.

Remove the drum gutter.

- ◆ Use caution since the remaining ingredients in the gutter may spill forward.
- ◆ Please make sure that the drum gutter does not get caught in the level sensor when taking it out and putting it back. (The level sensor might be broken.)

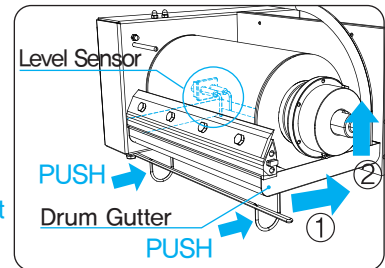

### STEP 11.

Press the VALVE button to remove the diluted sanitizer from the ingredient tank.

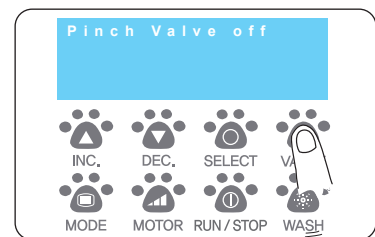

### STEP 12.

Open the drain plug and pour running water into the ingredient tank to clean it. Use a shower to clean the inside of the ingredient tank and the storage tank.

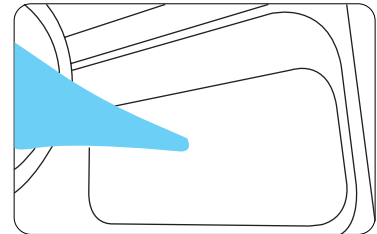

### STEP 13.

Assemble the drum gutter.

- ◆ Check whether the ingredient hose is stuck before assembling the drum gutter. If you find that the ingredient hose is stuck after assembling the gutter, lift it a bit to remove the hose.

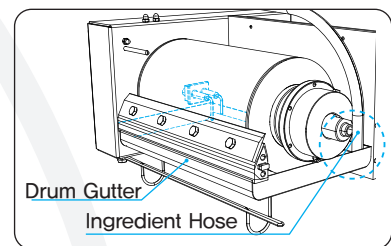

### STEP 14.

Spray diluted sanitizer in and outside of the machinery and let it dry in the air.

- ◆ The blade may rust, so it must be dried after cleaning before assembling.
- ◆◆ The blade is a consumable, so be sure to replace it when it rusts or every 6 months.  
The blade is available from the Ictro service center or your local dealer.

# MEMO

---



Online Internet Service  
<http://www.icetro.com>

