



STAINLESS STEEL

24" WIDE UNDERSHELVES FOR DISHTABLES

FEATURES:

Stainless steel construction featuring the adjustable die cast leg clamp.

CONSTRUCTION:

No welds. Shelf completely die formed.

MATERIAL:

Stainless steel.

Item #: _____ Qty #: _____

Model #: _____

Project #: _____

MODEL #	L	Wt.
DTA-SS-18	18"	11 lbs.
DTA-SS-24	24"	13 lbs.
DTA-SS-30	30"	15 lbs.
DTA-SS-42	42"	20 lbs.
DTA-SS-54	54"	23 lbs.
DTA-SS-66	66"	30 lbs.

MODEL #	L	Wt.
DTA-SS-78	78"	35 lbs.
DTA-SS-90	90"	39 lbs.
DTA-SS-102	102"	45 lbs.
DTA-SS-114	114"	50 lbs.
DTA-SS-126	126"	55 lbs.
DTA-SS-138	138"	59 lbs.

Size Undershell to be at least 6" shorter than dishtable.

Featuring as Standard:
"THE PROVEN"
 ORIGINAL ADVANCE TABCO
 Adjustable Undershell
 with Die Cast Leg Clamp



DTA-SS-42 Undershell Shown on Straight Dishtable

DIMENSIONS and SPECIFICATIONS

TOL ± .125"

ALL DIMENSIONS ARE TYPICAL

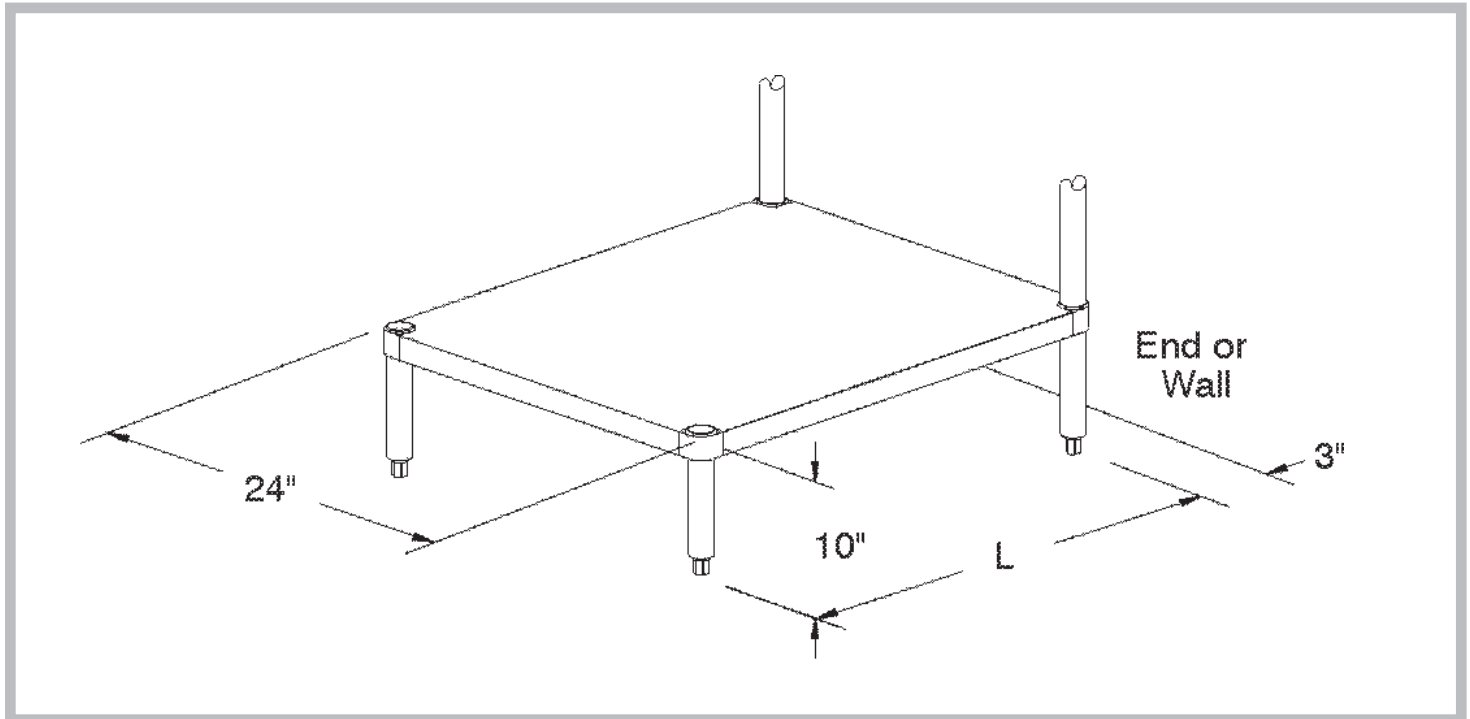

Customer Service Available To Assist You 1-800-645-3166 8:30 am - 8:00 pm E.S.T.

For Orders & Customer Service:

Email: customer@advancetabco.com or Fax: 631-242-6900

For Smart Fabrication™ Quotes:

Email: smartfab@advancetabco.com or Fax: 631-586-2933