

4072, AVENUE 12-FAUCET H-PIPE TOWER & 5034 TOP MOUNTED DRAINER WITH 630SS FAUCETS MOUNTING TEMPLATE

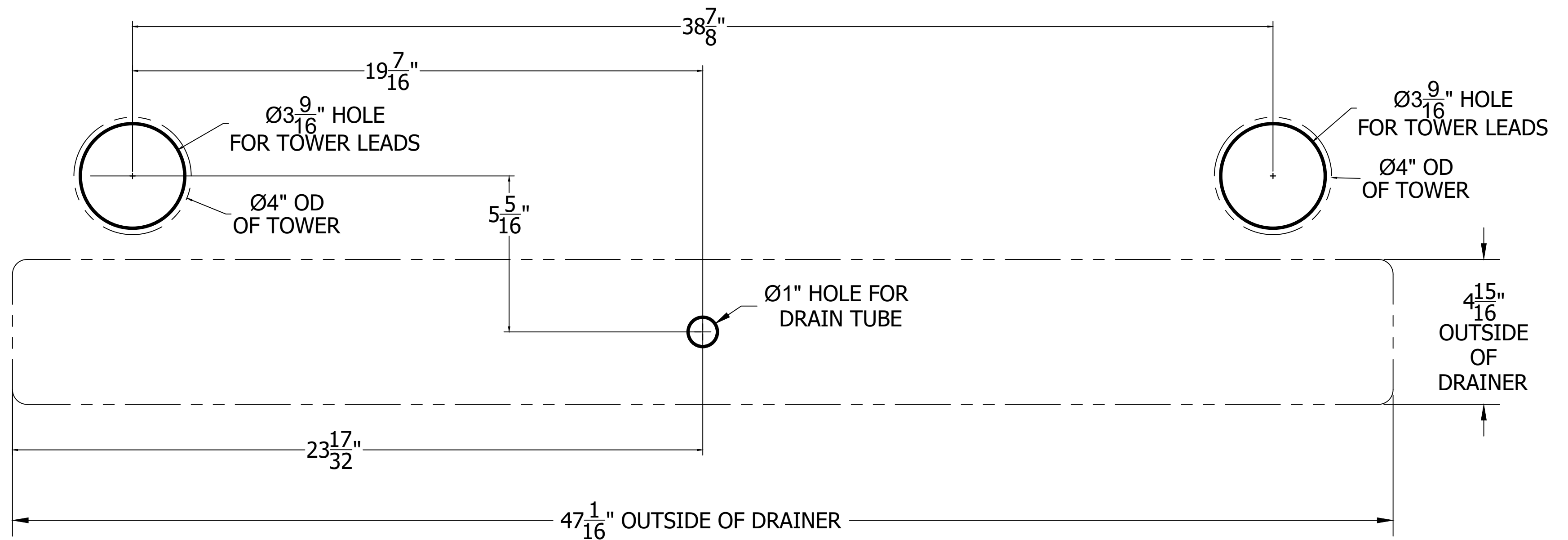
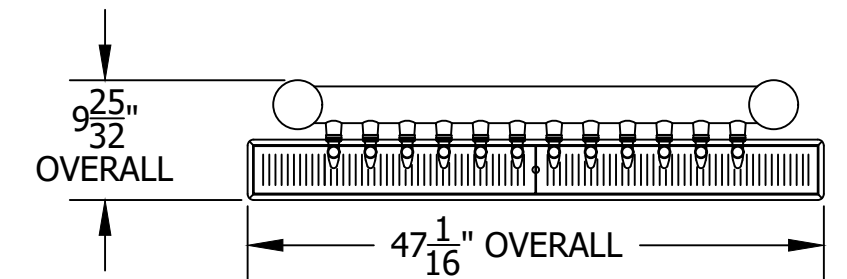
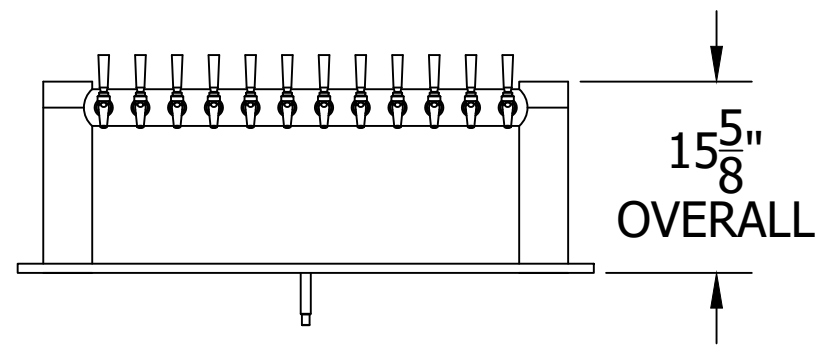

****DRAWING NOT TO FULL SCALE****

PERLICK CORPORATION
MILWAUKEE, WI 53223

PROPERTY OF THE PERLICK CORP.
NOT TO BE COPIED OR USED DETRIMENTAL TO OUR INTERESTS.

SCALE 1:3
DR. CGL DATE 4/5/2021

LAST MODIFIED
6/23/2021

1030635