



HOSHIZAKI

STEELHEART

SANDWICH PREP TABLES

FULL SIZE PAN RAIL CAPACITY

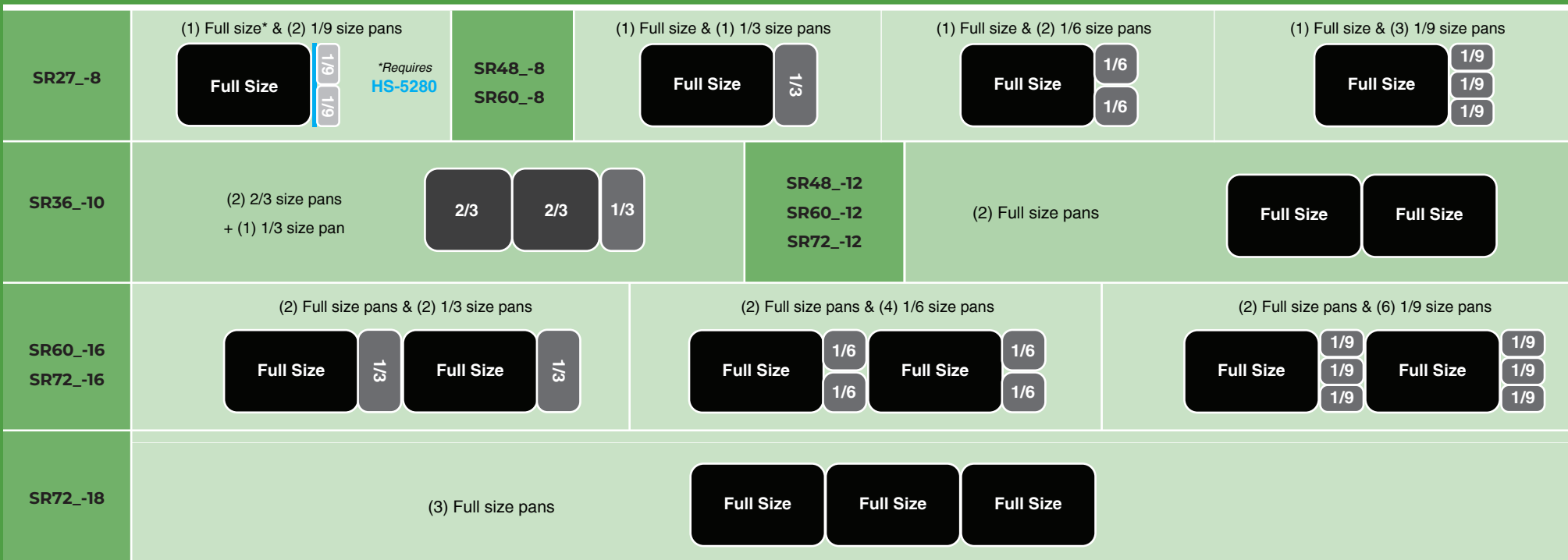

PAN SIZE	FULL SIZE 12 3/4" x 20 3/4"			2/3 SIZE 13 3/4" x 12 3/4"			1/2 SIZE 12 3/4" x 10 3/8"			1/2 SIZE LONG 20 3/4" x 6 7/16"			1/3 SIZE 12 3/4" x 6 7/8"			1/4 SIZE 10 3/8" x 6 3/8"			1/6 SIZE 6 7/8" x 6 1/4"			1/9 SIZE 6 3/4" x 4 1/4"	
	2-1/2"	4"	6"	2-1/2"	4"	6"	2-1/2"	4"	6"	2-1/2"	4"	6"	2-1/2"	4"	6"	2-1/2"	4"	6"	2-1/2"	4"	6"	2-1/2"	4"
Cups	36	60	88	25	40	57	16	28	40	16	28	40	10.5	18	26	6.4	12	19	10.5	18	26	2.5	5
Quarts	9	15	22	6	10	14.25	4	7	10	4	7	10	2.6	4.5	6.5	1.6	3	4.75	2.6	4.5	6.5	0.63	1.25

Pans by others. Full complement of 1/3 size pans, 4" deep, and divider bars are included. Pan sizes are industry standard, but actual sizes may vary slightly by manufacturer.

FULL SIZE PAN EQUIVALENCY CHART



Additional divider bars may be required to accommodate above pan layouts. Individual divider bars HS-4007 sold as Accessories.

Divider bars on the back

#52000 | 11/03/22



HOSHIZAKI

STEELHEART

DIVIDER BARS - CONFIGURATION SHEET

DIVIDER BAR CONFIGURATION IN SANDWICH PREP TABLES

Center divider bars have notches to accept interlocking side divider bars.

- Provides stability for pan placement by preventing side bars from sliding out of position which could allow pans to fall into cabinet below.
- Increased flexibility for user because center notches allow user to easily re-configure bars to accept desired pan sizes for their unique menu.
- Made of high quality stainless steel insuring long life.

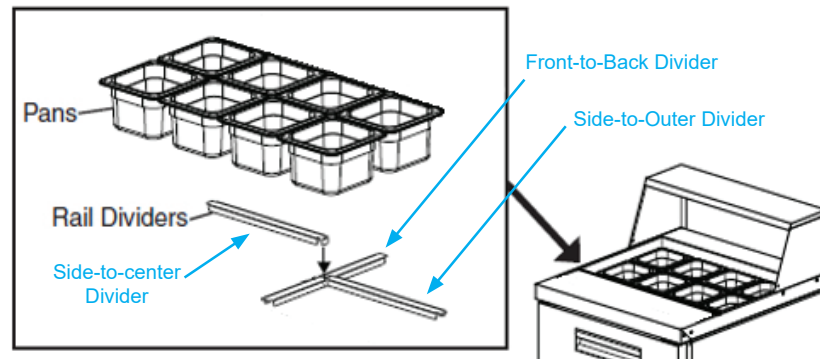

Front-to-Back Divider



Side-to-Outer Divider



Side-to-Center Divider



HS-5187

27-8

One divider bar per kit

HS-5188

All Others

One divider bar per kit

HS-5185

27-8

One divider bar per kit

HS-5189

-8, -16

One divider bar per kit

HS-5191

-18

One divider bar per kit

HS-5186

-10

One divider bar per kit

HS-5190

-12, -16

One divider bar per kit

HS-5192

-18

One divider bar per kit

INCLUDED DIVIDER BARS

SR27-8

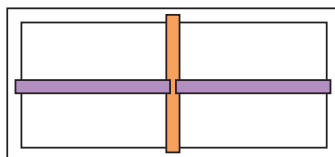

- (1) **HS-5187**: Front-to-Back Divider (13-3/4"; 348mm)
- (2) **HS-5185**: Side-to-Outer Divider (12-1/2"; 319mm)

SR36-10

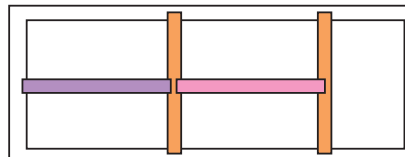

- (2) **HS-5187**: Front-to-Back Divider (13-3/4"; 348mm)
- (1) **HS-5185**: Side-to-Outer Divider (12-1/2"; 319mm)
- (1) **HS-5186**: Side-to-Center Divider (12-1/2"; 316mm)

SR48-8, SR60-8

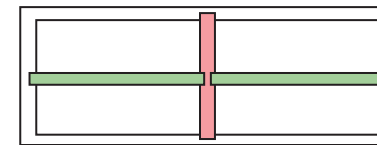

- (1) **HS-5188**: Front-to-Back Divider (12-5/8"; 322mm)
- (2) **HS-5189**: Side-to-Outer Divider (13-5/8"; 346mm)

SR48-12, SR60-12, SR72-12

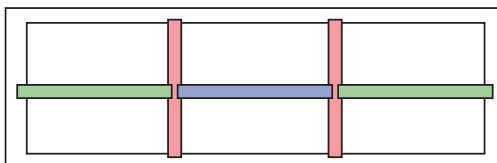

- (2) **HS-5188**: Front-to-Back Divider (12-5/8"; 322mm)
- (2) **HS-5189**: Side-to-Outer Divider (13-5/8"; 346mm)
- (1) **HS-5190**: Side-to-Center Divider (13-1/2"; 344mm)

SR60-16, SR72-16

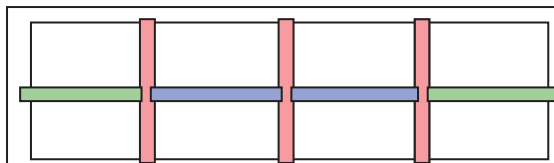

- (3) **HS-5188**: Front-to-Back Divider (12-5/8"; 322mm)
- (2) **HS-5189**: Side-to-Outer Divider (13-5/8"; 346mm)
- (2) **HS-5190**: Side-to-Center Divider (13-1/2"; 344mm)

SR72-18

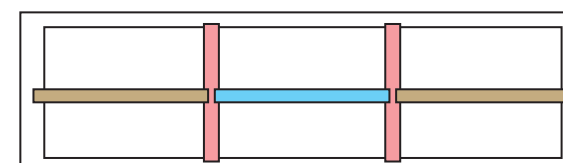

- (2) **HS-5188**: Front-to-Back Divider (12-5/8"; 322mm)
- (2) **HS-5191**: Side-to-Outer Divider (20-5/8"; 523mm)
- (1) **HS-5192**: Side-to-Center Divider (20-1/2"; 520mm)