



PROJECT: _____
 ITEM # _____ QTY: _____
 MODEL # _____
 AIA # _____ SIS # _____

CHEF BASE REFRIGERATOR

CHEF BASE REFRIGERATOR

CBR48HC



EXCLUSIVE WARRANTY

- ▶ 7 Year Parts, Labor and Compressor
- ▶ Exclusive 2 Year Warranty On Magnetic Door Gaskets
- ▶ Lifetime Warranty On Handles & Hinges (parts only)



CABINET CONSTRUCTION

- Stainless Steel Exterior (galvanized back & bottom)
- Aluminum Interior
- Marine Top Standard
- 3" Heavy Duty Casters
- 10' Cord And Plug (see electrical data for details)

REFRIGERATION

- Refrigeration System Uses R-290 Refrigerant To Comply With All Environmental Concerns
- Adaptive Defrost For Reduced Energy Consumption And More Consistent Product Temperatures
- Electric Defrost Heater With Hot Gas Condensate Evaporation
- Refrigerator Capable Of Maintaining Product Temperature 36°F To 38°F

FEATURES

- High Performance Refrigeration System With Electronic Control
- Top Weight Capacity 1000 lbs
- Heavy-Duty Drawer Slide Roller System
- 275 lbs Drawer Load Rating (per drawer)
- Heavy Duty, Fire-Proof Insulated, 16 Gauge Top
- No Heat Shield Required (must adhere to proper clearance per owners manual)
- Accommodates 6" Deep Full Size Food Service Pans (not included)
- Self-Closing Drawer Feature
- One Piece, Snap-In, Magnetic Drawer Gasket
- Compressor Available On Left Or Right, Specify At Time Of Unit Order



Please Verify Qualifying Units By Visiting:
www.energystar.gov/cfs

OPTIONS & ACCESSORIES

- Stainless Steel Back
- Stainless Steel Interior
- Drawer Locks
- Additional Pan Supports
- 6" Casters
- 6" Legs Or 6" Seismic Legs
- Flat Top Overhang (any size up to 6" overhang on each side)
- Remote Models* (6" legs only) (refrigerant must be specified at time of order, see note on back page)

3779 Champion Blvd, Winston-Salem, NC 27105

ph: (888) 845-9800 | fax: (800) 253-5168

Sales@VictoryRefrigeration.com | VictoryRefrigeration.com

Rev. 9/1/24 Printed in U.S.A.

APPROVAL: _____ DATE: _____

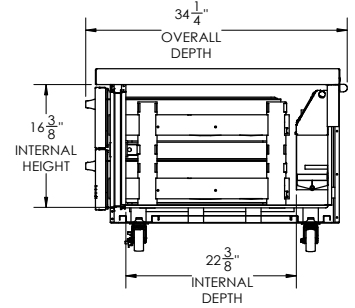
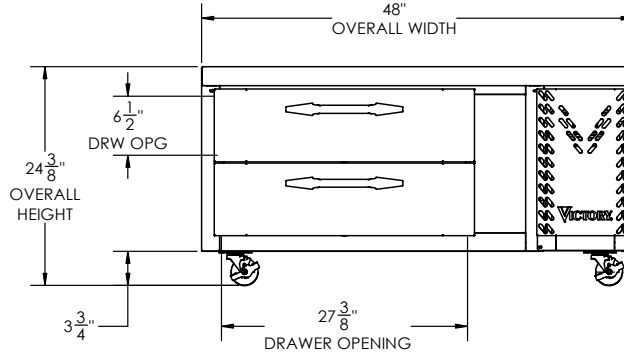
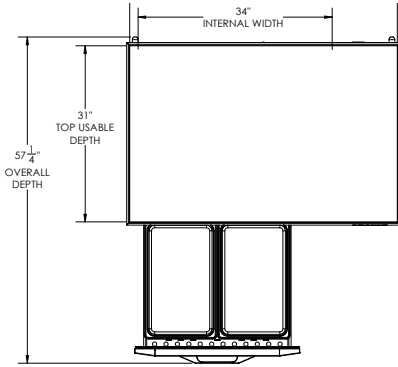

Drawer Configurations

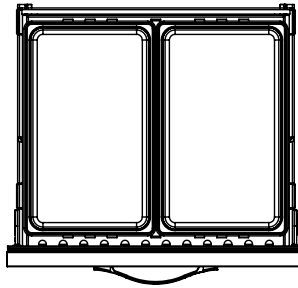

We reserve the right to change specifications and product design without notice. Such revisions do not entitle the buyer to corresponding changes, improvements, additions or replacements for previously purchased equipment. Dimensional tolerances +/- 1/4". Metric dimensions (MM)

3 3/16" Bottom & 1" Rear clearance is required

CHARACTERISTICS		ELECTRICAL DATA		SHIPPING DETAILS	
Net Capacity (cubic ft.)	7.21	Cabinet Voltage	115/60/1	Height	27"
Width, Overall (in.)	48"	Total Amperes	3.3	Width	58"
Depth, Overall (with handle)	34 1/4"	NEMA Plug (10' cord)	5-15P	Depth	38"
Height Overall (with casters)	24 3/8"	REFRIGERATION DATA		Crated Weight	375 lbs
Depth, Drawer Open 90°	57 1/4"	Condensing Unit Size, HP	1/3	*NOTE: Remote units are field wired and come with 6" legs. Refrigerant must be specified at time of order.	
Drawer Openings (in.)	27 3/8" x 6 1/2"	Refrigerant*	R-290		
No. Of Drawers / Pans (full size)	2 / 4	Capacity (BTU/HR) (100°F/20°F)	1942		
		Heat Rejection (BTU/HR)	2913		
		Charge (lbs/grams/ounces)	0.287 / 130 / 4.59		

3779 Champion Blvd, Winston-Salem, NC 27105 | ph: (888) 845-9800 | fax: (800) 253-5168

Sales@VictoryRefrigeration.com | VictoryRefrigeration.com

Rev. 9/1/24 Printed in U.S.A.