



Electronic Faucets

5EF-1D-DG-WS

TAG:

Electronic Sensor Faucet

Architect/Engineering Specifications:

Single hole deck mount electronic sensor faucet with polished chrome plated brass body and 5 11/16" rigid gooseneck, 1.5 GPM vandal resistant aerator, AC/DC control module, temperature control mixing valve with check valves and 18" flexible stainless steel supply hoses with 3/8" compression connections. Certified to ASME A112.18.1/CSA B125.1, NSF 61-Section 9, NSF 372 and UL 1951. Meets ADA ANSI/ICC A117.1 requirements.

Job Name _____
 Model Specified _____ Quantity _____
 Variations Specified _____
 Date _____

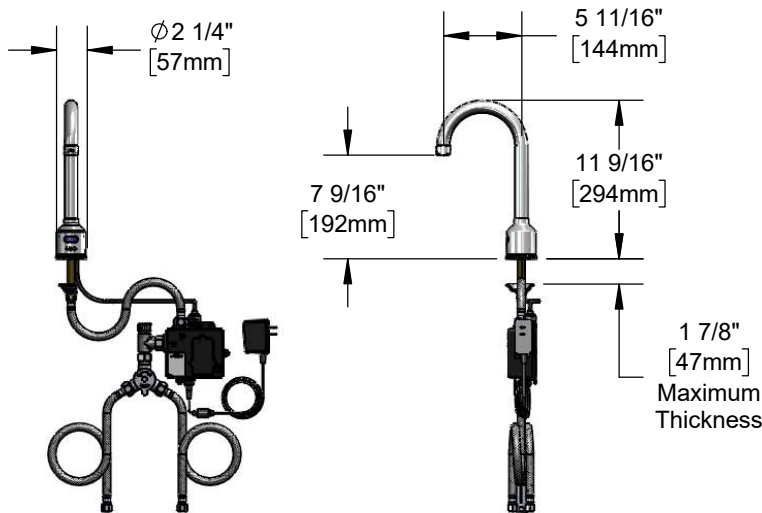

Features & Benefits:

- Single hole deck mount faucet w/ polished chrome plated brass body
- 5 11/16" rigid gooseneck
- 1.5 GPM vandal resistant aerator, Series 6 (B-0199-06-WS)
- Water resistant control module
- Plug in AC transformer or (4) AA battery (DC) power options
- Mechanical temperature mixing valve w/ integral check valves
- 18" flexible stainless steel supply hoses w/ 3/8" compression connections
- Low battery LED indicator light
- Material: Polished chrome plated brass body & tubular spout

Product Compliance:

- ASME A112.18.1 / CSA B125.1
- NSF 61 - Section 9
- NSF 372 (Low Lead Content)
- ANSI A117.1 (ADA)
- UL 1951



Warranty: One Year (Limited)

Performance Data:

- Pressure: 20 - 125 psi
- Temperature: 40 °F - 140 °F
- Flow Rate: 1.5 GPM @ 60 psi
- Water Consumption: @ 10 sec = .25 gal
@ 15 sec = .38 gal



ADA Compliant



Optional Outlets (Series 1 / VR Series 6)

GPM	Aerated	Non-Aerated (Laminar)	VR Aerated	VR Non-Aerated (VR Laminar)	Optional Deck Plates
0.35	N/A	<input type="checkbox"/> B-0199-01-N035	N/A	<input type="checkbox"/> B-0199-06-N035	<input type="checkbox"/> 4" Chrome Plated Brass Deck Plate
0.5	N/A	<input type="checkbox"/> B-0199-01-N05	N/A	<input type="checkbox"/> B-0199-06-N05	<input type="checkbox"/> 8" Chrome Plated Brass Deck Plate
1.0	<input type="checkbox"/> B-0199-01-F10	N/A	<input type="checkbox"/> B-0199-06-F10	N/A	
1.5	<input type="checkbox"/> B-0199-01-WS	<input type="checkbox"/> B-0199-29	Standard	<input type="checkbox"/> B-0199-29VR	
2.2	<input type="checkbox"/> B-0199-01	<input type="checkbox"/> B-0199-21	<input type="checkbox"/> B-0199-06	<input type="checkbox"/> B-0199-21-VRF	



equip Foodservice Accessories



• 2 Saddleback Cove • Travelers Rest, SC 29690
Ph 800-891-4808 • Fax 800-868-0084
www.tsbrass.com

Date: 09/10/18