

Architect/Engineering Specifications:

Single hole single temperature wall mount faucet with polished chrome plated brass body, ceramic cartridges, lever handle, 1/2" NPT female inlet, 40" riser, wall brackets, continuous pressure vacuum breaker, 36" flexible water hose with stainless steel quick disconnect, open epoxy coated steel hose reel with 3/8" x 50' hose, high flow spray valve, multi-fit bracket and adjustable hose bumper. Certified to ASSE 1056.

Job Name _____
 Model Specified _____ Quantity _____
 Variations Specified _____
 Date _____

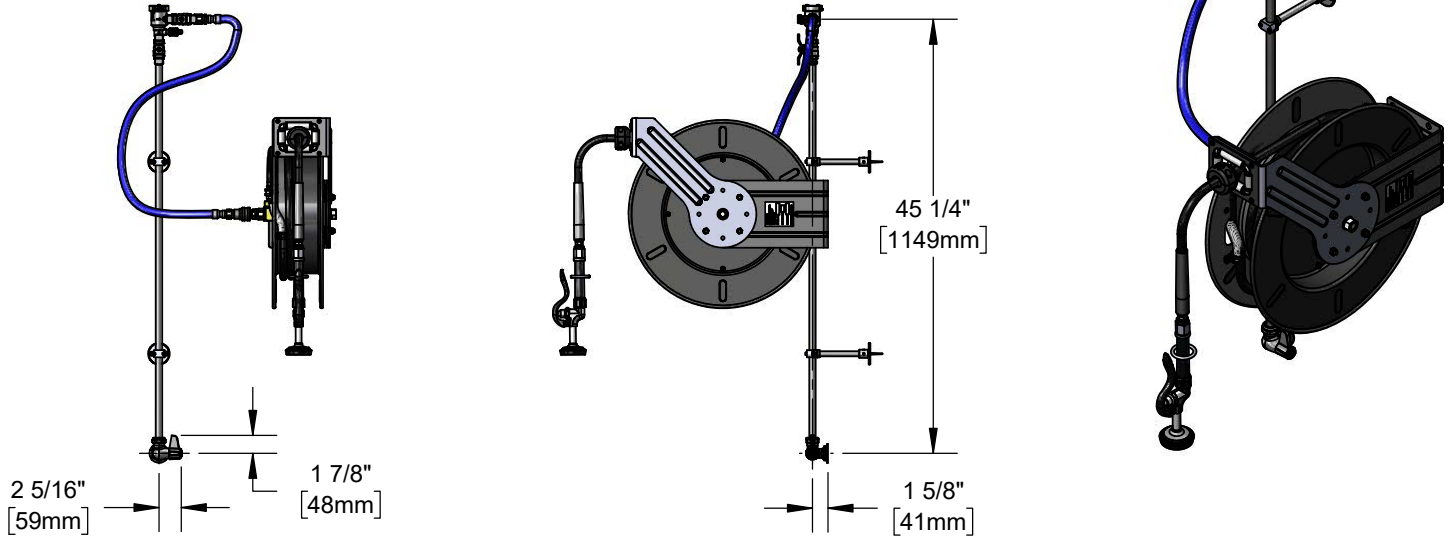

Features & Benefits:

- All-in-one system with exposed piping and accessories
- Single hole single temperature wall mount mixing faucet w/ polished chrome plated brass body
- Quarter-turn ceramic cartridges
- equip lever handle w/ screw
- 1/2" NPT female inlet with Ø 1 15/16" flange
- 40" riser
- (2) 3/8" wall brackets
- Continuous pressure vacuum breaker
- 36" flexible water hose connector with stainless steel quick disconnect
- Open epoxy coated steel hose reel w/ adjustable hose bumper
- Black high flow spray valve
- 3/8" x 50' hose
- Ratcheting system holds the length of hose until a slight tug to retract automatically
- Multi-fit bracket for wall, ceiling or under counter mounting
- Material: Polished chrome plated brass faucet body, riser and spray valve body, chrome plated handles, control valve, and vacuum breaker, epoxy coated steel open reel and wall bracket

Product Compliance:

- NSF 61 Exempt (Non-Potable)
- 2019 DOE PRSV Non-Compliant
- ASSE 1056 (VB)

Warranty: One Year (Limited)

Performance Data:

- Pressure: 20 - 125 psi
- Temperature: 40 °F - 140 °F
- Flow Rate: 2.27 GPM @ 60 psi