



Epoxy Coated Retractable Hose Reels

TAG:

5HR-242

Open Epoxy Coated Steel Hose Reel

Architect/Engineering Specifications:

Open epoxy coated steel hose reel, 3/8" x 50' hose, ratcheting system, multi-fit bracket, adjustable hose bumper and 3/8" NPT female inlet and 3/8" NPT male outlet.

Job Name _____
 Model Specified _____ Quantity _____
 Variations Specified _____
 Date _____

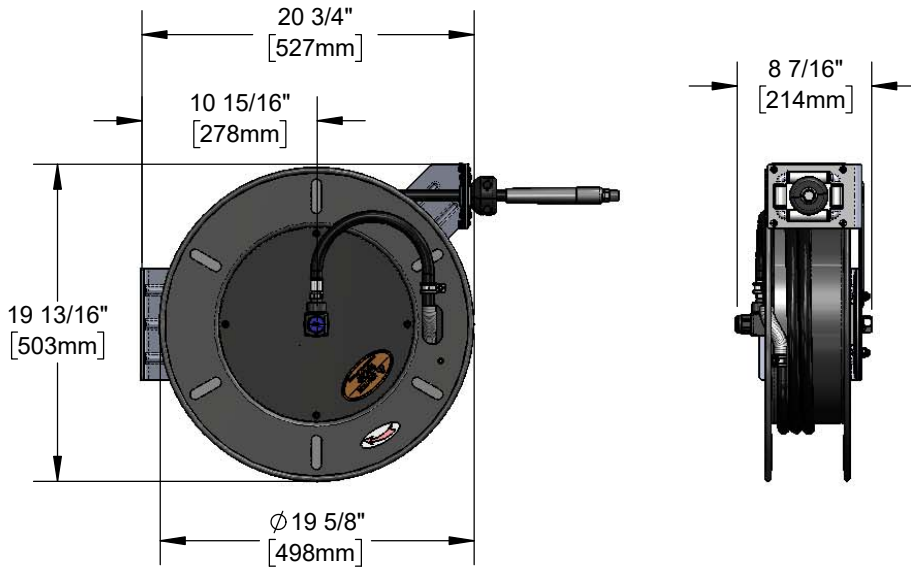
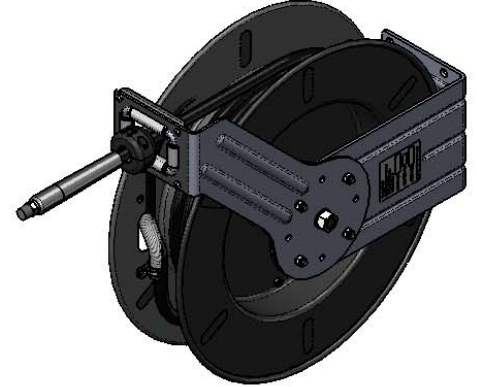

Features & Benefits:

- Open coated hose reel
- 3/8" x 50' hose
- Ratcheting system holds the length of hose until a slight tug to retract automatically
- 3/8" NPT female inlet
- 3/8" NPT male outlet
- Adjustable hose bumper
- Multi-fit bracket for wall, ceiling or under counter mounting
- Material: Epoxy coated steel open reel and wall bracket

Product Compliance:

- NSF 61 Exempt (Non-Potable)

Warranty: One Year (Limited)

- Hose: One year (Limited)

Performance Data:

- Pressure: 20 - 300 psi
- Temperature: 40°F - 140°F
- Flow Rate: 5.31 GPM @ 60 psi

(Outlet Device &/or Final Configuration May Reduce Performance Ratings)



equip Foodservice Accessories



• 2 Saddleback Cove • Travelers Rest, SC 29690
Ph 800-891-4808 • Fax 800-868-0084
www.tsbrass.com

Date: 05/11/18