



**DISPENSER
STAND**

IDS-0350/0450

KEY FEATURES:

- High quality construction and components
- Heavy duty stands for floor model dispenser (durable & rust-resistant)
- (4) 6.3" ~ 7.8" height adjustable stainless steel legs
- IDS-0350 Stand for use with ID-0160-AN, ID-0300-AN
- IDS-0450 Stand with flanged legs for use with ID-0450-AN



IDS-0350 Stand
Shown with a ID-0300-AN



IDS-0350



IDS-0450
with flanged legs



MODEL	WIDTH	DEPTH	HEIGHT		WEIGHT	
			(Stand only)	(Stand with machine)		
IDS-0350	16.5"	25"	34.25"	62.4"	65 lbs (Net)	90 lbs (Shipping)
IDS-0450	16.5"	26.5"	28.4"	68.5"	60 lbs (Net)	85 lbs (Shipping)

* Height included 6" legs

* Design and specifications are subject to change without prior notice.



IDS-0350/0450

ICE / WATER DISPENSER STANDS

PLAN VIEW: IDS-0350

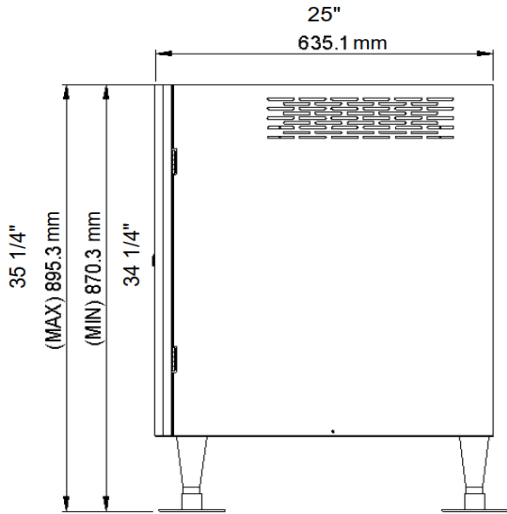

SIDE VIEW

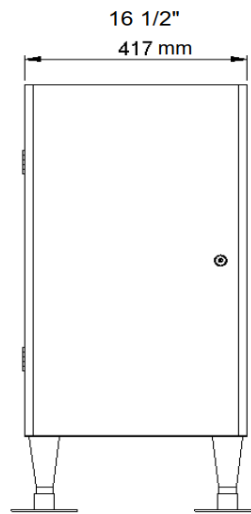

FRONT VIEW

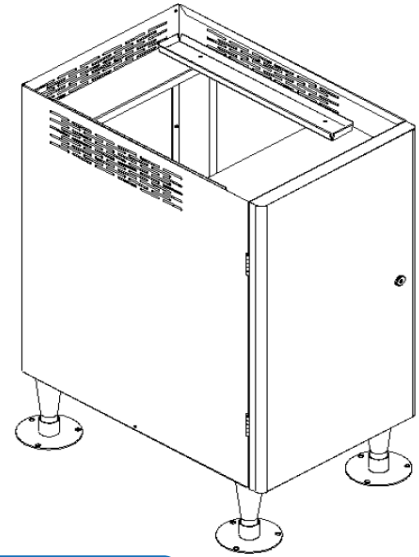

ANGLE VIEW

PLAN VIEW: IDS-0450

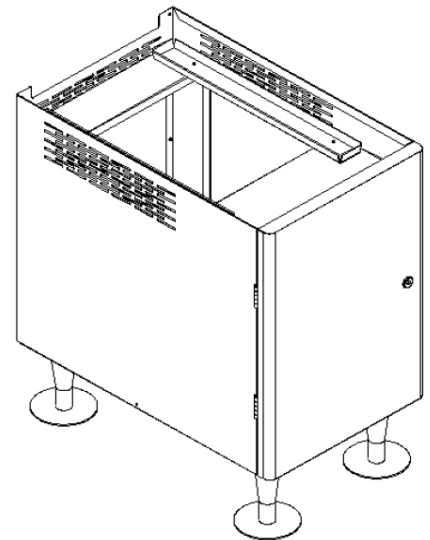
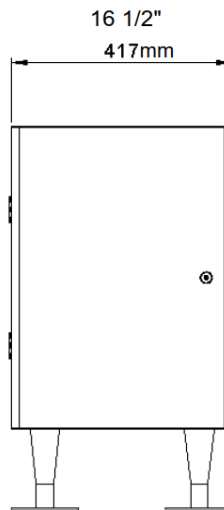
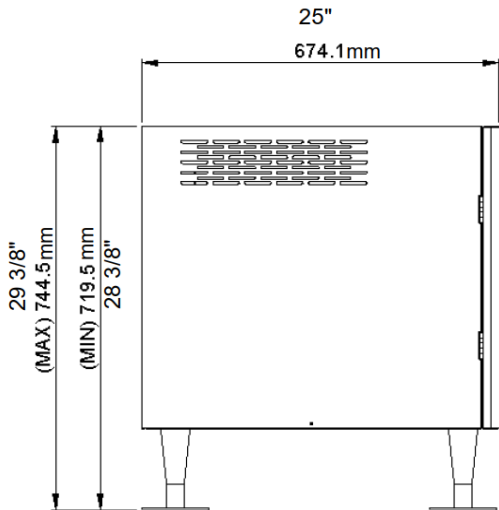

ICE TYPE:



Nugget Ice



IDS-0300 Stand (option)
shown with ID-0300-AN



* Design and specifications are subject to change without prior notice.