



"WE MAKE THE KITCHEN BETTER!"

ATOSA USA, INC.

Toll Free: 855-855-0399 Email: info@atosausa.com

www.atosa.com | www.atosausa.com

California, Colorado, Florida, Georgia, Illinois,

New Jersey, Ohio, Texas, Washington

Direct Draw Keg Coolers

Standard Features

- Stainless steel exterior & interior
- Electronic Temperature Controller
- Maintains temperatures between 33°F – 40°F
- Heavy duty Embraco compressor with environmentally friendly R290 refrigerant
- Slide out compressor assembly for easy maintenance
- Stainless steel drip tray(s)
- Recessed door handle(s)
- Dual tap tower(s) standard
- Interior light(s)
- Magnetic door gasket(s) standard for positive door seal
- Manifold and ball taps included
- Door lock(s) standard
- Pre-installed casters

Models	Half Barrel	Slim Quarter	Quarter Barrel	Sixth Barrel	Corny Keg	The Greg
MKC23GR	1					
MKC23GR		2		2		
MKC23GR			1			
MKC23GR				4		
MKC23GR					4	
MKC23GR						4
MKC58GR	2			2		
MKC58GR		4		4		
MKC58GR			2	2		
MKC58GR				8		
MKC58GR					8	
MKC58GR						8
MKC68GR	3					
MKC68GR		4		5		
MKC68GR			3			
MKC68GR				10		
MKC68GR					10	
MKC68GR						10
MKC90GR	4					
MKC90GR		6		7		
MKC90GR			4			
MKC90GR				14		
MKC90GR					14	
MKC90GR						14

For the best results of food preservation we recommend setting your refrigerator between 33°F to 38 °F

1. Don't forget to leave the unit some room to breathe!
2. Please clean the condenser frequently to give the unit more fresh air.



2 YEAR PARTS AND LABOR WARRANTY
5 YEAR COMPRESSOR PART WARRANTY

MODELS:

MKC23GR / MKC58GR / MKC68GR / MKC90GR



MKC23GR



MKC58GR



MKC68GR



MKC90GR





"WE MAKE THE KITCHEN BETTER!"

ATOSA USA, INC.

Toll Free: 855-855-0399 Email: info@atosausa.com

www.atosa.com | www.atosausa.com

California, Colorado, Florida, Georgia, Illinois,

New Jersey, Ohio, Texas, Washington

SPECIFICATIONS

Models	Door	Capacity (Cu.Ft.)	Shelves	Casters (inch)	Rated Current (A)	Voltage (V/Hz/Ph)	HP	Refrigerant	Exterior Dimensions (inch)	Net Weight (lb)	Gross Weight (lb)
MKC23GR	1	7.1	1	3.5	2.3	115/60/1	1/7	R290	23×31 ^{1/10} ×39 ^{3/10}	132	188
MKC58GR	2	17.3	0	2	2.3	115/60/1	1/7	R290	57 ^{4/5} ×28 ^{1/10} ×40 ^{1/10}	209	243
MKC68GR	2	21.5	0	2	2.3	115/60/1	1/7	R290	68×28 ^{1/10} ×40 ^{1/10}	234	291
MKC90GR	3	30.1	0	2	2.8	115/60/1	1/5	R290	89 ^{3/10} ×28 ^{1/10} ×40 ^{1/10}	282	357

PLAN VIEW

MKC23GR

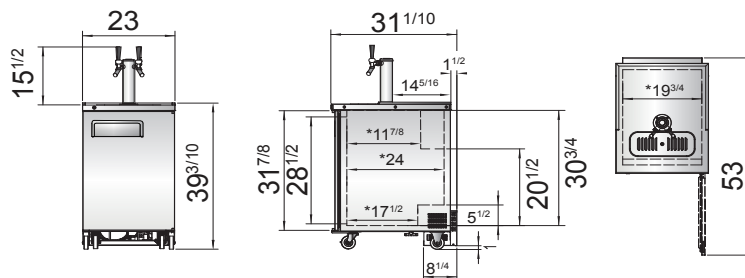

MKC58GR

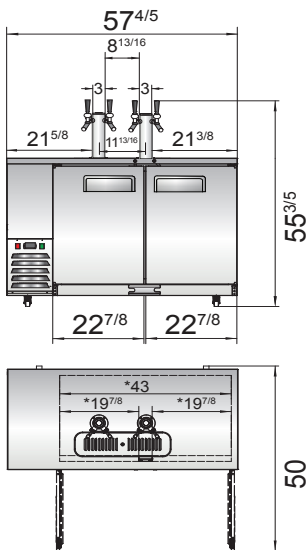

MKC68GR

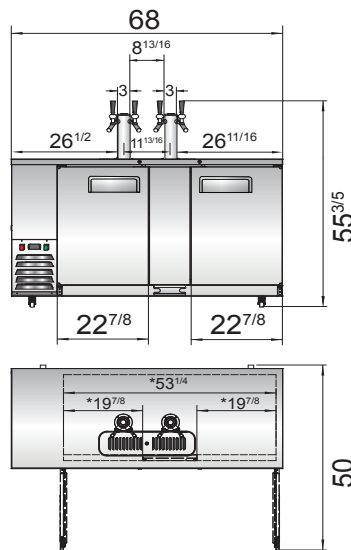

MKC90GR

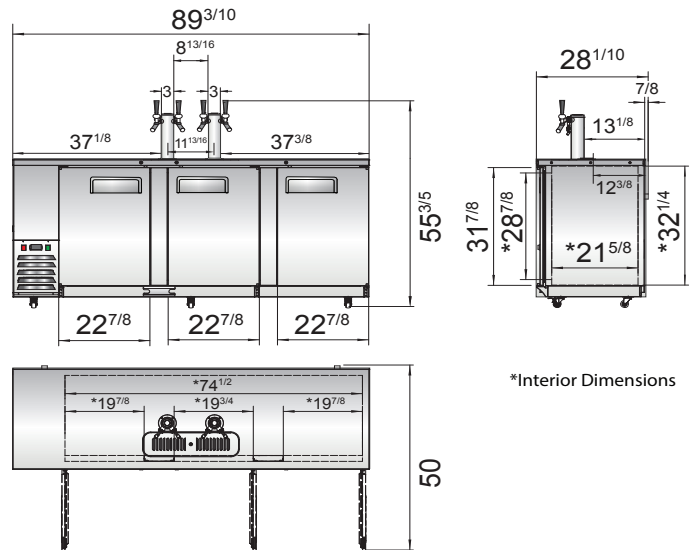

*Interior Dimensions

Dual tap towers

Stainless steel drip tray

Manifold and ball taps

