



Model: **16-131L** Item #: \_\_\_\_\_ Date: \_\_\_\_\_

Project: \_\_\_\_\_ Qty: \_\_\_\_\_ Approved By: \_\_\_\_\_

# Single Hole Deck Mount Remote 6" Swing Spout

Royal Series

## DESCRIPTION

- Single Hole, Deck Mount Remote 6" Swing Spout, Polished Chrome Finish, 1.8 GPM Female Aerator Installed



## STANDARD FEATURES

- Controlled by foot or knee valve
- Durable full range swing spout with double o-ring construction
- Warranty: 3 years

## SPECIFICATIONS

Water Inlet	1/2" NPS Male
Temp. Range	40°F - 180°F
Pressure	20-120 PSI
Rough In	7/8" Round Hole
Flow Rate	1.8 GPM
Material	Solid Brass
Finish	Polished Chrome
Weight	2 lbs.

## PRODUCT COMPLIANCE

- NSF-61 & NSF/ANSI 372
- ASME A112.18.1-2011/CSA B125.1-11 & NSF/ANSI 372
- Meets ANSI A117.1 (ADA)
- Massachusetts Approved
- CEC Approved

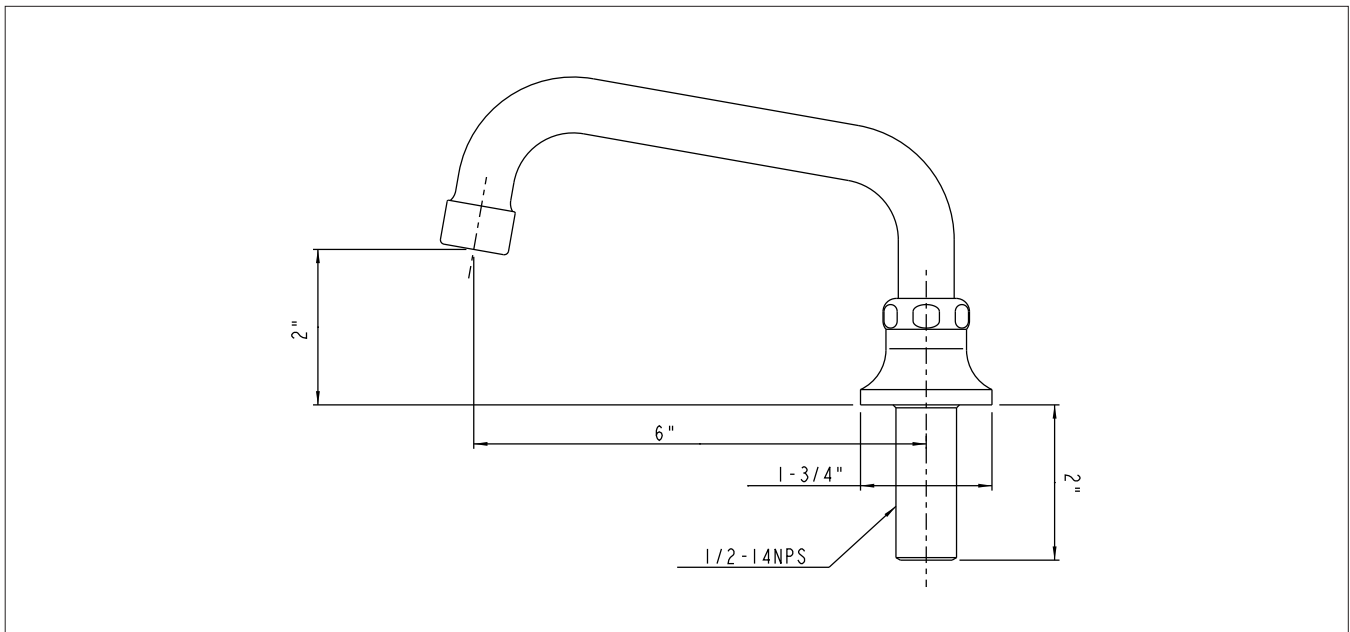

**WARNING:** Plumbing connections should be made by qualified personnel who will observe all applicable plumbing, sanitary and safety codes.  
California Proposition 65 Warning