



STAINLESS STEEL
**ECONOMY
 SILVER SOAK SINK**

Item #: _____ Qty #: _____
 Model #: _____
 Project #: _____

FEATURES:

Accommodates 20" x 20" dishwasher racks.
 Fabricated bowl welded at the seams.
 Top sink rim is furnished with a 2" x 1" square edge.

CONSTRUCTION:

All TIG welded.
 Welded areas blended to match adjacent surfaces and to a satin finish.

MECHANICAL:

Waste drain is 2" I.P.S. Twist handle lever operation.
 Tail-piece is chrome plated 4" long.
 Casters: 4 swivels - each wheel is 5" x 1", each rated at 125 lbs. - two casters furnished with brakes.

MATERIAL:

Heavy gauge type "304" stainless steel.
 Legs are stainless steel tubing.



Model #	Bowl Size	Approx. Wt.	Approx. Cu.
9-FSS-20-EC-X	22" x 22" x 8"	42 lbs.	7

DIMENSIONS and SPECIFICATIONS

TOL ± .500"

ALL DIMENSIONS ARE TYPICAL

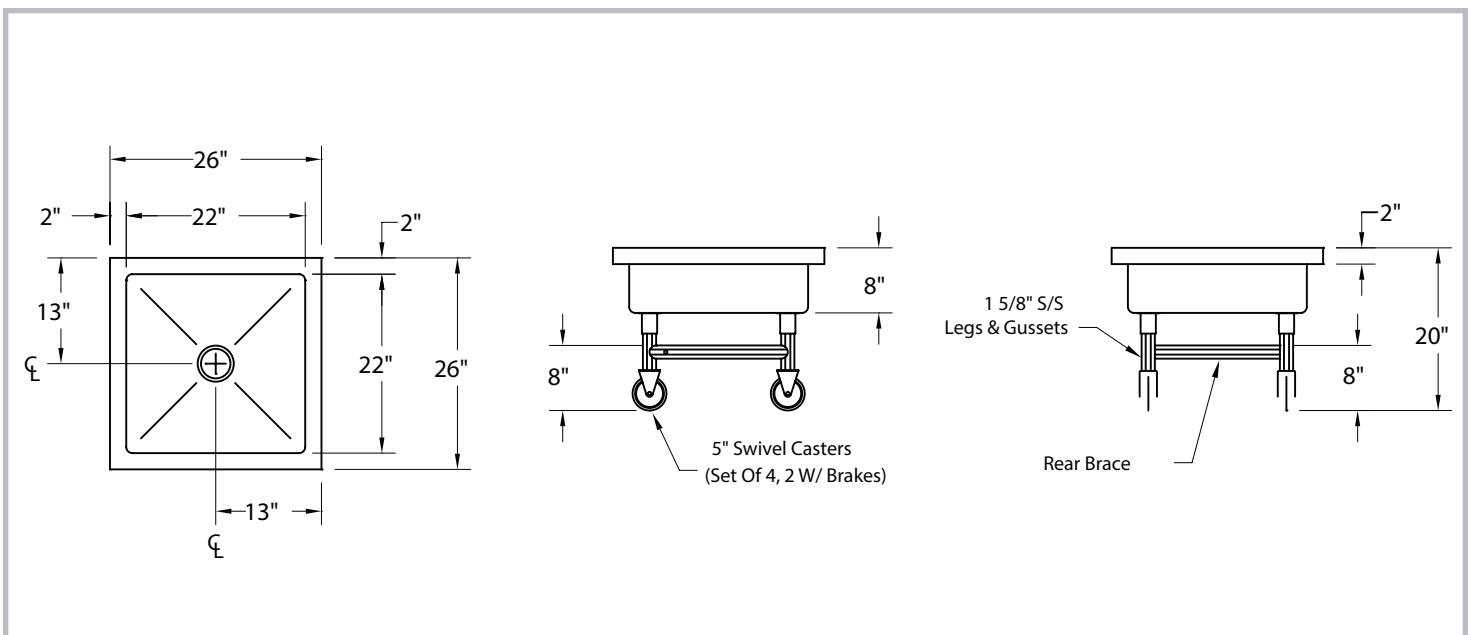

Customer Service Available To Assist You **1-800-645-3166** 8:30 am - 8:00 pm E.S.T.

For Orders & Customer Service:
 Email: customer@advancetabco.com or Fax: 631-242-6900

For Smart Fabrication™ Quotes:
 Email: smartfab@advancetabco.com or Fax: 631-586-2933