



DUKERS

Quality Commercial Refrigeration



UNDERCOUNTER REFRIGERATOR

MODEL DUC60R
2-Door











TECHNICAL SPECIFICATIONS

Voltage/Frequency	115V/60Hz
Refrigerant	R290
Type of Defrost	Automatic
Interior Material	Stainless Steel
Exterior Material	Stainless Steel
Temperature Range °F	33 ~ 41°F
Compressor Power (HP)	1/5
Nema Config.	NEMA5-15P



PRODUCT FEATURES

-  The back mount compressor structure is placed in the coolest possible area, provides quick and easy service.
-  Digital temperature controls with LED display for precise adjustment and automatic defrosting system.
-  Temperatures in the cabinet range from 33 to 41 degrees Fahrenheit
-  Higher Resistance to dust, high quality condenser.
-  R290 Natural Refrigerant, promotes faster cool down and efficient energy consumption
-  Self-closing doors at 60° with stay open feature.
-  Stainless steel inside and outside, sealed interior floors and rounder cabinet corners for easy cleaning.
-  High quality coated stainless adjustable shelves prevent peel and rust.
-  Lifetime warranty on hinges.



HIGH QUALITY STAINLESS STEEL & ROBUST DESIGN



Los Angeles | San Francisco | Dallas
Houston | Florida | Chicago | New Jersey

1-800-931-8628

@ info@dukersusa.com

www.DukersUSA.com

DETAILS & SPECIFICATIONS

UNDERCOUNTER DUC60R

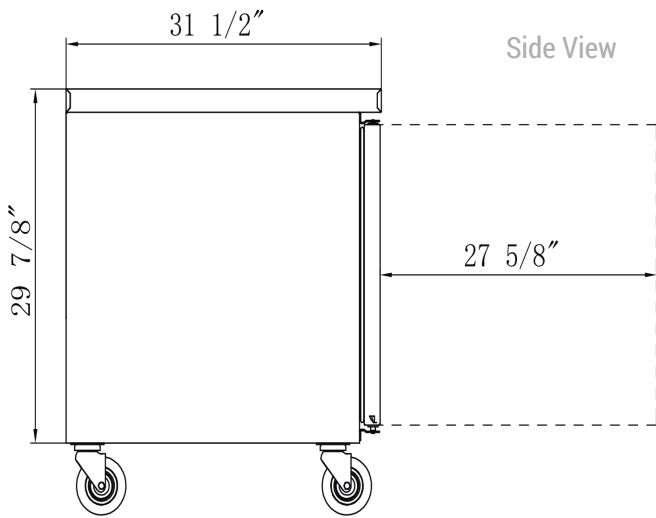
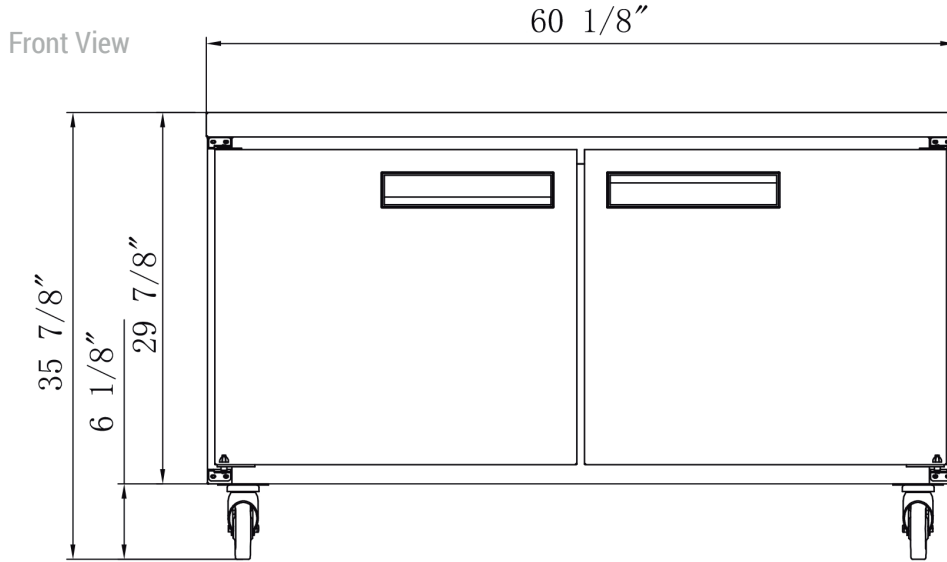

MODEL DUC60R

Rated Voltage	115V
Rated Frequency	60Hz
Total Input Power	280W
Total Current	2.4A
Total Capacity	15.53 cu ft
Climatic Category	4-5
Protection Type	I
Design Pressure High Side	300 PSIG
Design Pressure Low Side	150 PSIG
Insulation Blowing Gas	C-Pentane
Refrigerant	R290/3.88oz

MODEL	EXTERNAL DIMENSION WXDXH (INCHES)	PACKAGING DIMENSION WXDXH (INCHES)	PRODUCT NET WEIGHT	# OF SHELVES	40HQ CONTAINER CERT.
DUC60R	60 1/8 x 31 1/2 x 36	61 5/8 x 33 1/8 x 39 3/8	231 lbs	2	30



AutoQuotes



Los Angeles | San Francisco | Dallas
Houston | Florida | Chicago | New Jersey

1-800-931-8628

@ info@dukersusa.com

www.DukersUSA.com