



# EVOLUTION NATURAL GAS / PROPANE SERVICE MANUAL



## ACCUTEMP PRODUCTS INC

8415 N. CLINTON PARK DR • FORT WAYNE, IN 46825 • 800 480-0415 • [www.accutemp.net](http://www.accutemp.net)

SP8026-1201

Email: [service@accutemp.net](mailto:service@accutemp.net)

# **IMPORTANT FOR YOUR SAFETY**

The **Safety Instructions** listed on this page below, should be posted in a prominent location as a reminder of safe practices; as well as, recommended actions to follow in the event of an equipment or facility's utility issue.

## **WARNING**

In the event a **GAS ODOR** is **DETECTED**, **SHUTDOWN** all appliances at the Main Gas Shut-Off Valve and contact the local Gas Company or Gas Supplier Service.

## **WARNING**

In the event of a Power Failure, **DO NOT** attempt to operate this appliance.

## **WARNING**

**DO NOT** store or use Gasoline, or any other Flammable Vapor and/or Liquids in the vicinity of this or any other appliance.

## **WARNING**

**IMPROPER** installation, adjustment, alteration, service, or maintenance can cause personal injury or death; and/or property damage. Read the installation, operation, and service/maintenance instructions thoroughly; before installing or servicing this equipment.

## **WARNING**

Only **QUALIFIED** service technicians/electricians should perform the equipment installation, to ensure that all electrical and safety requirements are met; and that all wiring is performed in accordance with all national, state, and local electrical codes.

# WARNING SYMBOL DEFINITIONS

## SYMBOL DEFINITIONS

Symbols are used to attract your attention to possible dangers. They are only effective if the operator uses proper accident prevention measures. Some of the symbols are boxed text; while others maybe just picture icons. Please give this information the respect they deserve for safe operation.

### Warning Text Boxes

Below are definitions of the warning text boxes.

## **DANGER**

**Indicates an imminently hazardous situation; which, if unchanged, will result in death or serious injury.**

## **WARNING**

**Indicates a potentially hazardous situation; which, if unchanged, will result in death or serious injury.**

## **CAUTION**

**Indicates a potentially hazardous situation; which, if unchanged, will result in minor or moderate injury.**

## **NOTE**

**Advises the reader of information or instructions, vital to the operation or maintenance of the equipment.**

### Symbol Icons

Below are definitions of the symbol icons used in this manual.



## **ALERT**

Notifies the reader of an important message or warning; usually a safety related message.



## **INFORMATION**

Notifies the reader of an important information that may or may not be safety related.



## **CAUTION - HOT SURFACE**



## **DANGEROUS VOLTAGE**

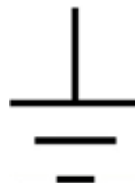

## **EARTH GROUND**

# **SAFETY PRECAUTIONS**

## **DANGER**

### **ELECTRICAL SHOCK HAZARD WHILE WORKING ON ENERGIZED EQUIPMENT.**

Unplug equipment prior to removing any components effected by electricity.

### **FLAMMABLE GAS HAZARD WHILE WORKING ON GAS EQUIPMENT.**

Shut-Off the Supply Gas Valve to the equipment prior to removing any components effected by supplied gas.

### **BURN HAZARD WHILE WORKING ON STEAM PRODUCING EQUIPMENT.**

When accessing the cooking chamber, be sure to always stand back while slowly opening the door to allow the chamber to vent off the steam. Never reach into the cooking chamber before it has completely vented off the steam.

Never reach into the cooking chamber or handle hot items without wearing the proper heat protective gloves. Steam coming out of the holes on the right side of the cooking chamber is invisible and can cause severe burns.

Water inside the steam chamber, creating steam, has a temperature of 212°F and will cause burns if touched or spilled on the skin.

### **PERSONNEL INJURY HAZARD WHILE PICKING UP OR MOVING HEAVY EQUIPMENT.**

Always use 2 people and proper lifting techniques when picking-up, moving, or flipping-over heavy equipment.

### **SLIP & FALL HAZARD WHILE WORKING ON WATER HOLDING EQUIPMENT.**

Keep the floor in front of the equipment clean and dry. If spills occur, clean them up immediately to avoid potential injuries.

# **WARNING & CAUTION NOTES**

## **WARNING**

**ONLY QUALIFIED SERVICE TECHNICIANS SHOULD PERFORM MAINTENANCE ON THIS EQUIPMENT.**

## **CAUTION**

- **DO NOT use abrasive materials, such as wire brushes or metal scouring pads to clean the Water Sensors.**
- **DO NOT use Aluminum Oxide Sandpaper to clean the Water Sensors or Ignitor/Flame Sense Probes. It leaves a residue that will not allow Water Sensors to work properly.**
- **DO NOT manually fill water above the Water Level Mark on the left side of steam chamber above the High Limit Level Sensor.**

# **TABLE OF CONTENTS**

## **SAFETY**

Important For Your Safety.....	i
Warning Symbol Definitions.....	ii
Safety Precautions.....	iii
Warning & Caution Notes.....	iv

## **T.O.C. & MANUAL HISTORY**

Table of Contents.....	v-vi
Revision Sheet.....	1

## **NOTES**

Operational Condition Notes.....	2
Troubleshooting Notes.....	3

## **OPERATIONAL & COMPONENT INFORMATION**

Purpose Reference of Main Component Chart.....	4-6
Additional Component Part Numbers.....	6
Sequence of Operation.....	7-9
Modifying Control/Keypad Program Settings.....	10

## **TROUBLESHOOTING**

Troubleshooting Flow-Diagram.....	11
Flow-Diagram Reference Troubleshooting Chart.....	12-14

## **COMPONENT REMOVAL & INSTALLATION**

Location of Electrical Components Picture Overview.....	15
Electrical Components Removal & Installation.....	16-20
Cord & Plug Assembly.....	16
Water Sensor Control Board.....	16
Water Sensors.....	16
Transformer.....	17
Temperature (RTD) Probe.....	17
Control/Keypad Board.....	17
Overtemp Switch (ThermalLimit SW3).....	18
Ignition Module.....	18
Time-Delay Relays.....	18
Chamber Pressure Switch.....	19
Control Relays.....	19
Ignitor & Flame Sense Probe.....	19
Door Switch.....	20
Fuses.....	20

# TABLE OF CONTENTS

## COMPONENT REMOVAL & INSTALLATION (CON'T)

Location of Gas Components Picture Overview.....	21
Gas Components Removal & Installation.....	22-24
Power Burner Blower.....	22
Gas Control Valve.....	22
Gas Enrichment Valve.....	23
Power Burner Blower Pressure Switch.....	23
Gas Orifice.....	24
Location of Gas Burner & Gas Burner Box Picture Overview.....	25
Gas Power Burner Removal & Installation.....	[2 PERSONS REQUIRED].....26
Gas Power Burner Box Removal & Installation.....	[2 PERSONS REQUIRED].....27-28
Heat Transfer Plate Location Picture Overview.....	29
Heat Transfer Plate Removal & Installation.....	[2 PERSONS REQUIRED].....30-31
Heat Transfer Plate Installation Notes & Cautions.....	32
Miscellaneous Components Removal & Installation.....	33-34
Auto-Fill Valve.....	
Overfill (Reed) Switch.....	[2 PERSONS REQUIRED]..... 33
Float Ball (Magnetic).....	33
Drain Ball-Valve.....	[2 PERSONS REQUIRED].....34
Drip Pan.....	34
Door Components Removal & Installation.....	34...35-37
Door Assembly.....	
Inner Door Panel.....	35
Door Handle Latch Assembly.....	35
Door Hinge.....	36
Door Gasket.....	36
	37

## SCHEMATIC & CHARTS

Electrical Schematic AT1T-3736 Rev G (S/N 36980 and Below).....	38
Electrical Schematic AT1T-3736 Rev H (S/N 36981 and Above).....	39
Gas Orifice Size to Altitude Chart.....	40
Ignitor/Flame Sense Probe Spacing Measurements.....	41

# **REVISION SHEET**

Current Revision: 1201  
Date: 1/31/12

Prior Revision: N/A  
Date: N/A

Change:  
Initial Release.



## OPERATIONAL CONDITION NOTES

### OPERATIONAL CONDITION NOTES

- The Water Column (WC) value for the gas pressure being supplied to the steamer should be between: Natural Gas = 7" to 10" WC Propane Gas = 11" to 13" WC.
- If the supplied gas pressure coming into the steamer is .5 PSI (13.8" WC) or higher; an External Gas Regulator is needed in-line, prior to entering the steamer. *If an External Regulator is required, it must be rated at 125% of the BTU/hr rating or higher.*
- The micro-Amp ( $\mu\text{A}$ ) value for the Flame Sense Probe (to ignite the Burner Gas) must be at a minimum value of  $2.5 \mu\text{A}$ . (Ignition Module pins FC+ & FC-) *The Ignition Module will shutdown if value is below  $.07\mu\text{A}$ .*
- **AUTO-FILL STEAMER:** The water pressure being supplied to the Auto-Fill Valve should not be greater than 60 psi.

#### Measuring Gas Pressure Setup

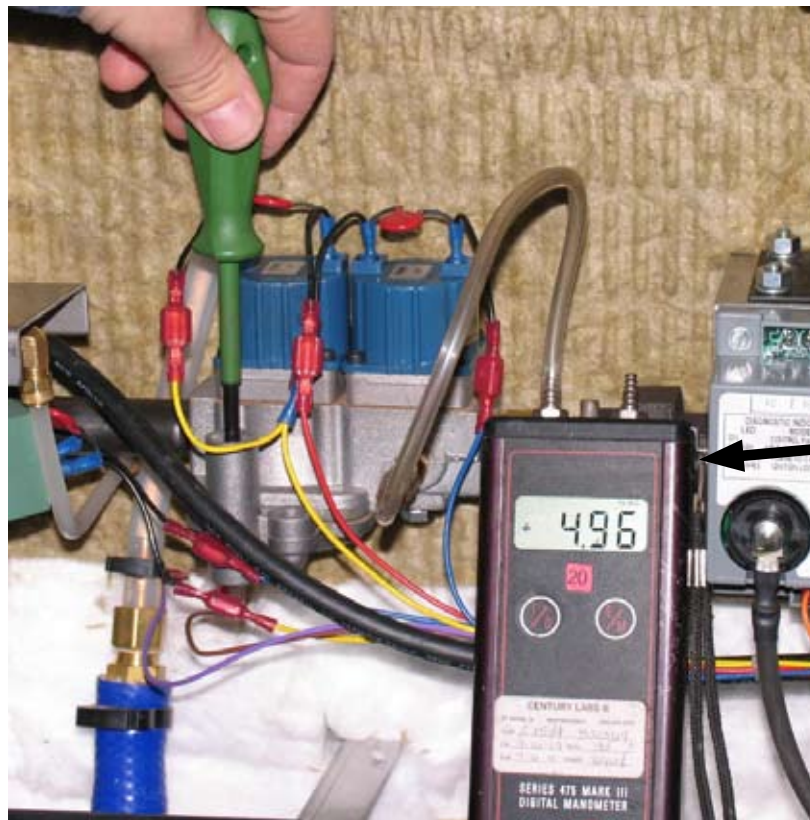

Manometer

## TROUBLESHOOTING NOTES

# TROUBLESHOOTING NOTES

**If the steamer's gas burner is not igniting, ensure that you have verified and recorded the following, prior to calling the AccuTemp Service hotline:**

- With the Gas Burner operating, the Water Column (WC) value of the gas pressure from the steamer's Gas Control Valve is 5" WC = Natural Gas or 10" WC = Propane Gas.
- The micro-Amp ( $\mu\text{A}$ ) value of the Flame Sense Probe (Ignition Module pins FC+ & FC-) should have a minimum value of 2.5  $\mu\text{A}$ .

**If the steamer is not reaching temperature:**

- Ensure that the steamer is not in the HOLD Mode versus the COOK Mode. The default mode for the steamer, when the PWR button is turned ON, is COOK. So, if the operator presses the Timer Button then the Cook/Hold button; the operator has just placed the steamer in the HOLD Mode and the steamer will not reach 212°F (COOK Mode).
- Ensure that the steam vent (located on the back of the steamer) is not blocked or clogged. If the customer has added an extended exhaust pipe, there's an increased chance of vent blockage, if the exhaust pipe is not installed properly. The exhaust pipe should be made of copper, galvanized or stainless steel. The exhaust pipe should have a diameter of 3/4"; and be sloped 1/4" for every 12" of length (recommend a height no greater than 24"). Also, the addition of extra fittings that can alter the gravitational flow of the steam condensation, can cause blockage. If vent blockage does occur, it will cause the chamber pressure switch to stay open; which prevents the heater from turning back on; and the temperature will continue to drop. Blocked vent can additionally cause steam to blow out of the door.

**Auto-Fill Steamer: If the steamer is overflowing with water and causing the steamer to shut-off:**

- Ensure the steamer is level, front to back and side to side. An un-level steamer can cause the water in the steam chamber to collect in the front of the steamer, causing the Over-Fill Float Ball to raise and trip the Reed Switch prematurely (every time the steamer is turned ON). Once the Reed Switch trips, it will cause an Over-Fill Light and Buzzer; while turning off the steamer and preventing its usage.
- Ensure that both of the Water Sensors are clean. Build-up of scale or crud will prevent the Water Sensors from providing the appropriate control signals to the Auto-Fill Valve, causing it to overflow with water.
- Ensure that the water pressure being supplied to the Auto-Fill Valve should not be greater than 60 psi. If water pressure is too high, then a larger volume of water will be added to the steam chamber during the auto-fill cycle; causing the steamer to overflow with water.

## PURPOSE REFERENCE OF MAIN COMPONENTS

Component	Part #	Purpose
Transformer	<u>Assembly Part#</u> AT0A-2779-3	<ul style="list-style-type: none"> <li>Steps-down the Supply Line Voltage to 24 -28VAC.</li> </ul>
Overtemp Switch ( <i>Thermal Limit SW3</i> )	AT1E-2653-4	<ul style="list-style-type: none"> <li>Normally closed switch that provides a safety feature to the machine in case the Gas Heater overheats.</li> <li>If the Gas Heater <u>overheats</u>, the switch will <u>open</u> and turn the steamer <u>off</u>; while lighting the red LED Overtemp Light on the Control Panel.</li> <li>The steamer will <u>not</u> turn on until the temperature has dropped enough to allow the Overtemp Switch to close again.</li> </ul>
Control / Keypad Board	AT0E-3625-1	<ul style="list-style-type: none"> <li>Human interface for steamer operations through push-buttons, operations, &amp; display readouts.</li> <li>Provides power to Control Relay #2 (24VDC).</li> <li>Receives input from the Temperature (RTD) Sensor and displays the water temperature on the LED readout.</li> <li>Maintains the preset HOLD temperature.</li> </ul>
Water Sensor Control Board	AT0E-3230-2	<ul style="list-style-type: none"> <li>Receives inputs from Water Sensor Probes and implements corresponding actions for those inputs based on the water level in the steam chamber.</li> <li>Controls the Auto-Fill Valve (<i>if installed</i>) and receives inputs that provides actions for the desired water level needs.</li> </ul>
Water Sensor Probe	AT1E-2652-1	<ul style="list-style-type: none"> <li>Teflon exterior with a stainless steel center that uses the minerals in the water to complete the electrical circuit to the Water Board.</li> <li><b>MUST BE CLEAN TO WORK PROPERLY.</b></li> </ul>
<i>Low Water Level Probe</i>		<ul style="list-style-type: none"> <li>Once the Low Water Sensor is satisfied, it will allow the Ignition Module to activate.</li> <li>If the water level is below the sensor, the Water Board will activate the Auto-Fill Valve (<i>if installed</i>) filling the unit the water until the High Limit Water Sensor is satisfied.</li> </ul>
<i>High Limit Water Level Probe</i>		<ul style="list-style-type: none"> <li>On initial chamber water fill, once the water level reaches and satisfies the Operational Water Sensor, the Water Board will keep the Auto-Fill Valve open for 30 additional seconds..</li> <li>After initial chamber water fill, when the water level drops below the sensor's operational level; the Water Board will open the Auto-Fill Valve for 30 seconds to raise the water level back above the High Limit Water Sensor.</li> <li>This process will repeat as long as the water level stays above the Low Water Sensor.</li> </ul>
Auto-Fill Valve (OPTIONAL)	AT1A-3841-1	<ul style="list-style-type: none"> <li>Solenoid Valve that allows water to flow into the steam chamber; that is controlled automatically by the Water Board based on inputs from the Water Sensor Probes.</li> </ul>

## PURPOSE REFERENCE OF MAIN COMPONENTS

Component	Part #	Purpose
Water Over-Fill Sensor Switch (OPTIONAL)	<u>Reed Switch:</u> AT0A-3519-3  <u>Float Ball:</u> AT0P-3233-1	<ul style="list-style-type: none"> <li>Magnetic Reed Switch is used in conjunction with a Float Ball. If the water rises too high, the switch opens and turns off the steamer.</li> <li>When the switch opens, the High Water Overfill LED will light. The user will have to drain the water out and turn the steamer back ON; otherwise, the steamer will remain shutdown.</li> </ul>
Control Relay #1 (AC)	AT0E-2825-5	<ul style="list-style-type: none"> <li>Controls AC Volt input &amp; output signals which provide actions from the Water Sensor Board and Auto-Fill Valve (<i>if installed</i>).</li> </ul>
Door Switch	AT0A-3660-1	<ul style="list-style-type: none"> <li>Magnetic Switch used to ensure that the door is closed and latched prior to generating steam</li> <li>Ignition Module will <b>not</b> activate if this switch is <b>not</b> closed (Door Open).</li> </ul>
Chamber Pressure Switch	<u>S#: 34769 &amp; Up</u> AT0E-3617-2  <u>S#: 34768 &amp; Lower</u> AT1A-3847	<ul style="list-style-type: none"> <li>Normally closed switch that allows pressure to build-up inside the steam chamber.</li> <li>Opens when the steam chamber pressure reaches 1/2 PSI.</li> <li>Ignition Module will <b>not</b> activate if this switch is <b>not</b> closed (Switch Open).</li> </ul>
Time Delay Relay #1	AT0E-2500-1	<ul style="list-style-type: none"> <li>Normally open switch that closes after 5 seconds (once Door Switch &amp; Chamber Pressure Switch are closed) to allow the Ignition Module to activate and light the Gas Burner.</li> </ul>
Control Relay #2 (DC)	AT0E-2825-6	<ul style="list-style-type: none"> <li>Receives 24VDC (if the safety conditions are met) to the coil allowing the Ignition Module to activate the Power Burner Blower.</li> </ul>
Power Burner Blower	AT0E-3759-1	<ul style="list-style-type: none"> <li>Provides the correct amount of air into the Gas Burner Box to allow the gas from the Gas Burner to ignite and burn efficiently.</li> </ul>
Blower Pressure Switch	AT0E-3617-3	<ul style="list-style-type: none"> <li>Closes once air pressure from the Power Burner Fan is applied.</li> <li>Ignition Module will <b>not</b> activate if the switch is <b>not</b> closed (Switch is Open due to no air from the Blower or the switch is defective).</li> </ul>
Ignition Module	AT0E-3760-1	<ul style="list-style-type: none"> <li>Receives inputs and provides control signals to the Gas Control Valve and Gas Enrichment Valve.</li> <li>Provides the voltage to the Ignitor Probe to ignite the gas from the Gas Power Burner.</li> <li>Senses the input from the Flame Sense Probe (if there is a flame from the Burner or not) and makes appropriate control signal outputs based if there is a flame from the burner or not.</li> </ul>
Ignitor Probe	<u>Assembly Part#</u> AT1E-3795-1	<ul style="list-style-type: none"> <li>Uses high voltage, supplied by the Ignition Module, to form a spark between the Ignitor Probe and the GND Probe.</li> <li>Ignites the gas/air mixture from the Gas Power Burner.</li> </ul>
Flame Sense Probe		<ul style="list-style-type: none"> <li>Verifies that a flame is present and if no flame is sensed; the Ignition Module will go into lockout and deactivates all gas valves.</li> </ul>

## PURPOSE REFERENCE OF MAIN COMPONENTS

Component	Part #	Purpose
Time Delay Relay #2	AT0E-2500-2	<ul style="list-style-type: none"> <li>Closes for 4 seconds, on initial start-up, to allow the Gas Enrichment Valve to open; providing a high concentration of gas to help ignite poor quality gas on cold start-ups.</li> </ul>
Gas Enrichment Valve	AT0P-3818-1	<ul style="list-style-type: none"> <li>Used to provide a richer concentration of gas to the Burner on cold start-ups. Helps to compensate for poor quality supplied gas.</li> <li>Controlled by Time Delay Relay #2 and the Ignition Module.</li> </ul>
Gas Control Valve	Natural Gas: AT2E-1806-2 Propane Gas: AT2E-1806-3	<ul style="list-style-type: none"> <li>Controls and maintains a constant flow of gas to the Gas Power Burner.</li> <li>Controlled by the inputs from the Ignition Module.</li> </ul>
Gas Orifice	Natural Gas: AT0B-3758-1 Propane Gas: AT0B-3758-2	<ul style="list-style-type: none"> <li>Provides the correct ratio of gas volume and pressure to the burner via a preset diameter hole size.</li> <li>Orifice Size for <b>NG: .1360</b> &amp; for <b>PG: .0935</b></li> </ul>
Gas Power Burner	AT1A-3768-1	<ul style="list-style-type: none"> <li>Dispenses the mixture of gas and air evenly over its surface to provide maximum flame and heat dispersal efficiency.</li> </ul>
Gas Power Burner Box	AT1A-3769-1	<ul style="list-style-type: none"> <li>Chamber that positions the Burner and contains the flue gasses produced from the burner's flame.</li> </ul>
Temperature (RTD) Sensor	AT0E-3626-1	<ul style="list-style-type: none"> <li>Provides temperature input to Control/Keypad Board, which displays the temperature in the steam chamber based on resistance changes from the Temperature (RTD) Sensor.</li> <li>Used to maintain the preset HOLD mode temperature.</li> </ul>
Door Assembly	AT1A-3600-1	<ul style="list-style-type: none"> <li>Keeps the steam trapped inside the steam chamber to allow pressure to build and cycle the Chamber Pressure Switch.</li> </ul>
Drain Valve	AT1P-2239-1	<ul style="list-style-type: none"> <li>Manually Open/Close valve used to drain water from the steam chamber.</li> </ul>

## ADDITIONAL COMPONENT PART NUMBERS

Component	Part #	Component	Part #
Pilot Lamp, 24V Red	AT0E-1800-2	Inner Door Assembly	AT1A-3647-1
Fuse, Slo-Blo 3A	AT0E-2731-1	Door Hinge (Pair)	AT1H-2058-3
Ignition Cable	AT0E-3810-1	Door Latch Assy, Ceramic Magnet	AT1H-3609-1
Gasket, Door	AT1G-2633-1	Door Latch Mounting Plate	AT1M-3046-1

# SEQUENCE OF OPERATION

## ***MANUAL FILL:***

### Power Cord Plugged-In & PWR Button Not Pushed

- Line Voltage (120/240VAC) comes in through the Terminal Strip and 3A fuse until it reaches the Transformer.
- Line Voltage is also applied to the Ignition Module on pin L1, after it goes through the 3A fuse.
- The Transformer steps-down the Line Voltage to 24VAC and applies that, through the Overtemp Switch & *Overflow Reed Switch (Auto-Fill Only)*, to the Water Sensor Board, the Control/Keypad Board, and Ignition Module on pin V2.
- *(The red LED light on the Water Sensor Board will be flashing at a rapid rate.)*
- The AC coil of Control Relay #1 (CR#1) is energized.

### PWR Button Pushed & Water Level Is Below the Low Water Level Sensor

- PWR Button pushed and the Low Water Light Indicator will be ON and Alarm will sound.
- *(The red LED light on the Water Sensor Board will continue to flash at a rapid rate.)*
- **PRE** is displayed on the Control/Keypad Board.

### PWR Button Pushed & Water Is Filled to the Water Level Mark

- PWR Button pushed and the Low Water Light Indicator will be OFF and no Alarm will sound, due to the Low Water Level Sensor being satisfied. *(The red LED light on the Water Sensor Board will have a 1 second flash rate.)*
- Low Water Sensor's signal will close the Water Sensor Control Board's K2 Relay, which will turn-off the Low Water Light and send a power signal to pin 5 of Control Relay #2 (CR#2), pin 24VAC of the Ignition Module, and the Gas Control Pilot Valve.
- The Control/Keypad Board will send a 24VDC signal to Control Relay #2 closing the DC coil *(as long as the Door Switch and the Chamber Pressure Switch is closed; allowing the Time Delay Relay #1 to close after a 5 second delay, which will create a buffer for power to the DC coil).*
- Control Relay #2's DC coil is closed, allowing the power signal from K2 Relay to pass from pin 5 to pin 3 of Control Relay #2; sending power to the Ignition Module on pin TH.
- *(If the Gas Power Burner does not ignite, the Ignition Module will look-out; and the steamer will have to be turned OFF and back ON to get the steamer to try and re-light the Gas Power Burner.)*

# SEQUENCE OF OPERATION

## **MANUAL & AUTO-FILL:**

### Ignition Module

- Power signal to the Ignition Module's pin TH, activating the Power Burner Fan from pin IND on the Ignition Module.
- Air pressure from the Power Burner Blower will close the Power Burner Blower Pressure Switch, supplying power to pin PSW.
- Ignition Module will send control signals from pin V1 to the Time Delay Relay #2, and to the Gas Control Main Valve. At the same time, Ignition Voltage is sent to the Ignitor Probe creating a spark between the probe and GND.
- The Time Delay Relay #2 operates for 4 seconds, allowing the Gas Enrichment Valve to supply a dense amount of gas (compensation for poor quality source gas), in conjunction with the Gas Control Valve's gas.
- The Ignition Module will look for a signal from the Flame Sense Probe, via pin S1, to indicate that the gas was lit and burning a flame. *If no flame is sensed within 4 seconds of ignition start, then the Ignition Module will lockout and prevent the steamer from operating.*

### Gas Power Burner & Heat Transfer

- When the Gas Enrichment and Gas Control Valves are opened, gas is sent through the Gas Orifice and mixed with air from the Power Burner Fan; then it is distributed through the Gas Burner's surface ports to be ignited by the Ignitor Probe's spark.
- Flame Sense signal will cause the Ignition Module to keep the Gas Control Valve open, supplying gas to the burner. *(The flame should be a blue color for maximum efficiency.)*
- The heat generated in the Gas Burner Box will be transferred, by the Heat Transfer Plate, evenly over the bottom of the steam chamber; boiling the water inside to create steam for cooking.

### Temperature Sensor (RTD) and Control/Keypad Board

- As the temperature rises in the steam chamber, the RTD will provide a signal, based on the resistance of heat variance, to the Control/Keypad Board to provide a digital Temp Display.
- Control Panel will show **PRE** on initial heat-up until the steam chamber reaches **195°F**; then **COO** will be display between **195°F** and **212°F**.
- The operating default mode on initial power ON is COOK mode; which causes the steamer to go to the operating temperature of **212°F**.
- In HOLD mode; the steamer's temperature is displayed on the Control Panel until the HOLD temperature's preset value is reached; then **HLD** is displayed. The Control/Keypad Board will regulate temperature via the RTD input, based on that HOLD preset value. *(This value can be changed using the program function on the Control/Keyboard Control.)*

# SEQUENCE OF OPERATION

## ***AUTO-FILL (OPTIONAL):***

### Power Cord Plugged-In & PWR Button Not Pushed

- Same as Manual Fill.

### PWR Button Pushed & Water Level Is Below the Low Water Level Sensor

- PWR Button pushed and the Low Water Light Indicator will be lit.
- *(The red LED light on the Water Sensor Board will be flashing at a rapid rate.)*
- The Water Sensor Board sends a signal to the Water Sensor Board's K1 Relay to open the Auto-Fill Valve and start filling the steam chamber with water.
- *(This process will continue every time the water level falls below the Low Water Level Sensor.)*

### PWR Button Pushed & Water Level Is At the Low Water Level Sensor or Above

- Same as Manual Fill.

### Water Level Is At the High Limit Water Level Sensor

- When the water level reaches the High Limit Water Level Sensor, the Water Sensor Board will continue to activate the Auto-Fill Valve for 30 seconds then turn it off.
- *(The red LED light on the Water Sensor Board will have a 2 second flash rate.)*
- This process will continue every time the water level falls below the High Limit Water Level Sensor.

### Water Level Is Filled Too High in the Steam Chamber

- When the water level gets to high in the steam chamber, the Float Ball will rise on the Reed Switch sensor peg until the Reed Switch does not read the magnetic field from the Float Ball.
- This will cause the Control Relay #1 AC coil's voltage to drop, dis-engaging the relay from the steamer's normal operation; and also lighting the High Water (Over-Fill) Indicator Lamp on the Control Panel.
- Loss of Control Relay #1 cause the loss of the control signal to pin 5 of Control Relay #2; causing it to turn off the Ignition Module and close the Gas Control Valve which stops the gas feed to the Gas Power Burner.
- *(To restart the steamer, drain the water out until the High Water (Over-Fill) Indicator Light turns-off. Pressing the PWR button ON will begin the start-up procedure.)*



# MODIFYING CONTROL / KEYPAD PROGRAM SETTINGS

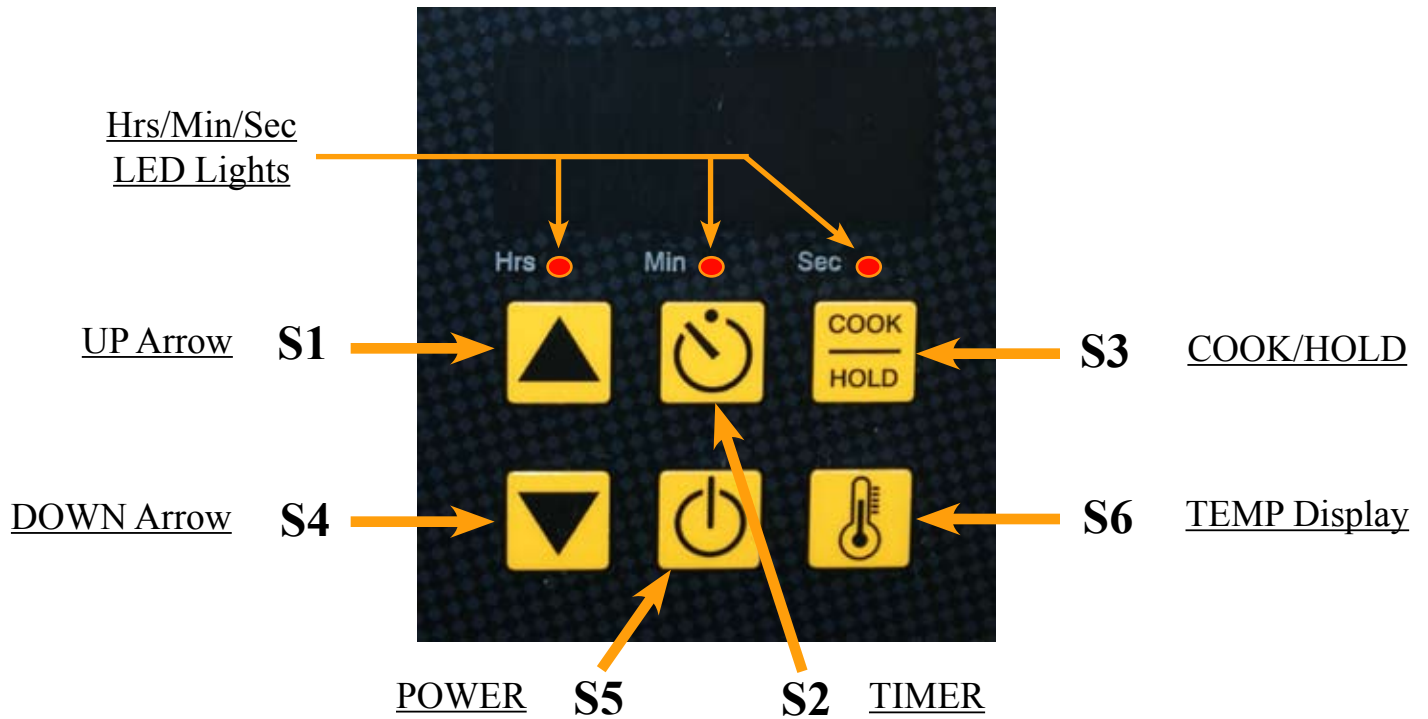

- S1 - Increase Program Item (Will cycle the Hrs/Min/Sec LED light)
- S4 - Decrease Program Item (Will cycle the Hrs/Min/Sec LED light)
- S3 - Increase Program Value (Will change the Digital Readout display)
- S6 - Decrease Program Value (Will change the Digital Readout display)
- S2 - **Exit & Save**

**ENTERING PROGRAM MODE:** Simultaneously, depress and hold **S4 & S6** for minimum of **8 seconds** or until the **Hrs LED** blinks and the display shows a Hold Temp number (default is 180°F). Now the Controller can operate under the Program Function Parameters.

***Program Mode Function Parameter Table***

Hrs LED	Min LED	Sec LED	PARAMETER	MIN	MAX	GAS
Blink	OFF	OFF	HOLD Temp Value = Degree F	MIN Temp	MAX Temp	180
ON	OFF	OFF	Default Timer Value = Hours	0	8	0
OFF	ON	OFF	Default Timer Value = Minutes	0	59	30
OFF	OFF	ON	TEMP Probe Offset = Degree F	0	50	0
ON	ON	ON	TEMP Probe Offset = Neg/Pos Diff	NEG = 1	POS = 0	0
<b>Blink</b>	<b>Blink</b>	<b>Blink</b>	<b>Hysteresis</b>	2	10	<b>3</b>
<b>ON</b>	<b>Blink</b>	<b>Blink</b>	<b>TEMP Regulating Mode</b>	On/Off = 0	PID = 1	<b>0</b>
Blink	ON	Blink	Proportioning BAND TIME	4	10	10
Blink	Blink	ON	Proportioning BAND WIDTH	4	10	10

**RESETTING CONTROLLER TO FACTORY DEFAULT VALUES ON THE GAS STEAMER CAN CAUSE AN IGNITION MODULE CONTROL FAULT.**

# TROUBLESHOOTING FLOW-DIAGRAM

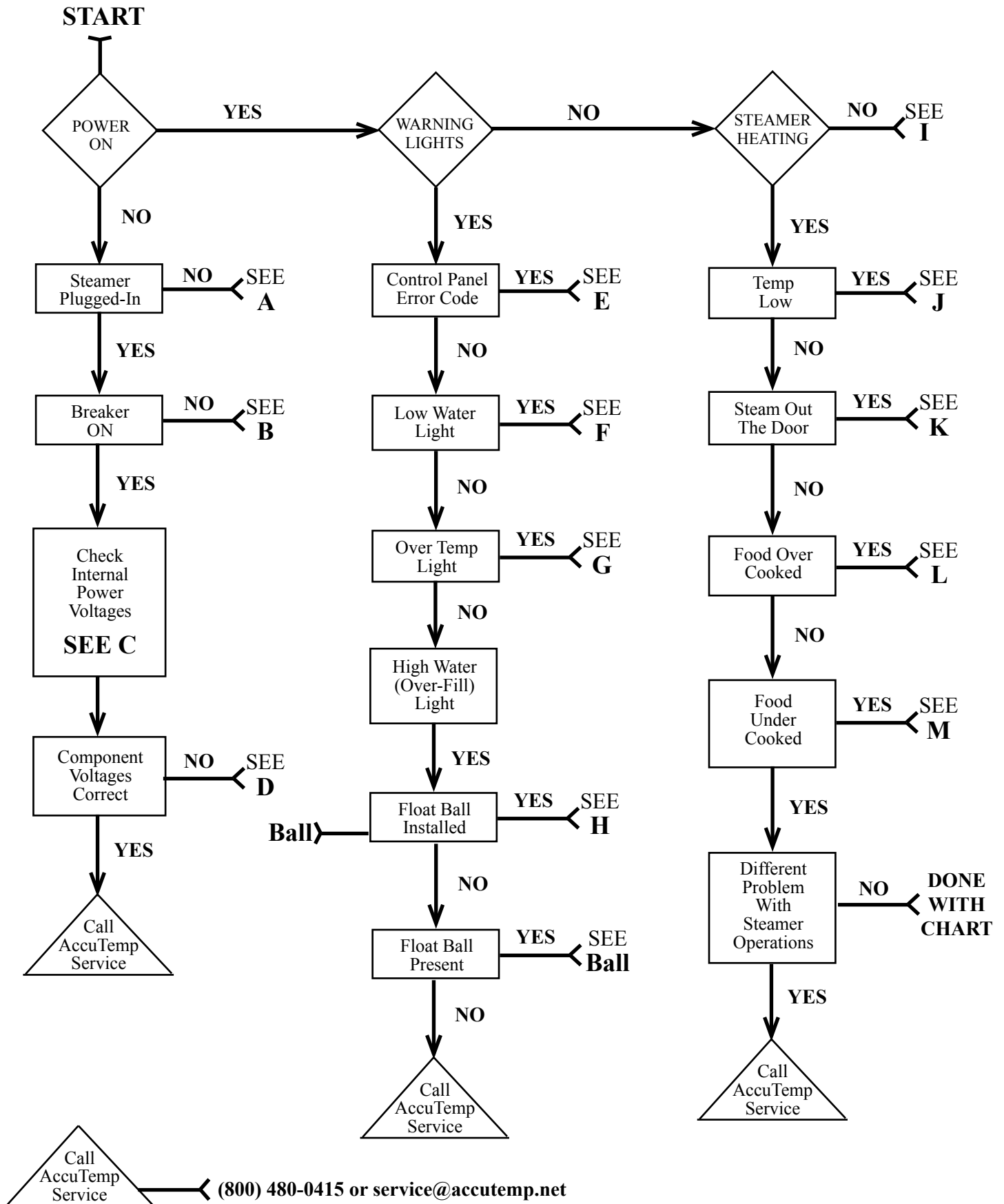

# FLOW-DIAGRAM REFERENCE TROUBLESHOOTING CHART

REF LETTER	POSSIBLE CAUSE	EVALUATION
<b>A</b>	Power Cord Disconnected	Confirm proper voltage is present at receptacle. Plug-in Power Cord.
<b>B</b>	Breaker Is Tripped	Unplug steamer and check line voltage at plug-in receptacle. Reset Breaker.
<b>C</b>	Transformer	Check for proper incoming line voltage to the primary side and 24VAC on the secondary side.
	Fuses	Check for blown fuses.
	Over-Temp Switch	Check between the common wire, terminal # 6 on the Control Relay #1 and the brown wire after the fuse.
	Control panel not responding.	Check for 24VAC incoming power at pins J2-1 & J2-2. Check for out put at pins J7-3 & J7-4 (ON/OFF) = 24VAC
<b>D</b>	Bad Component or Faulty Wiring	Check the wiring to the component; including wire-to-connectors, GND's, and damage. If a component output is bad, then it may need replaced.
<b>E</b>	Error Code: -1F or -99F for Temperature (RTD) Probe.	Check for 1000 ohms (at room temp) on Control/Keypad Board on J3 - Pins 1 & 2. EC: -1F = Open Temp (RTD) sensor EC: -99F = Shorted Temp (RTD) sensor
<b>F</b>	Low Water Sensor Not Satisfied	Ensure water level is above Low Water Sensor Probe inside the steam chamber. Ensure that the Low Water Sensor is cleaned and that the Water Board is working properly.
<b>G</b>	Steamer Has Over-Heated	Check that the water level inside steam chamber is not empty; and <b>refill if needed.</b> <i>If an Auto-Fill unit, then ensure that water supply is not shut-off, or Auto-Fill Valve is faulty.</i> Ensure Water Sensors are clean.
<b>H</b>	Too Much Water In Steam Chamber	<b>DO NOT OPEN DOOR!</b> Open Drain Valve until the High Water Light goes off. If light <b>DOES NOT</b> go out and no water in steamer, then possibly a sensor fault.
	Operational Water Level Sensor Faulty	Ensure the top Water Sensor is clean. Check that Water Board is working properly.
	Float Ball & Reed Sensor Faulty	Ensure Float Ball is not stuck on the Sensor Post. Ensure Sensor Post & inside of the Float ball are clean. Check continuity of the Reed Switch ( <i>Float over sensor creates continuity; the Float off the sensor is open.</i> )
<b>I</b>	Control/Keypad Panel	Check for 24VDC output (J7 Pins 1 & 2).
	Door Switch Not Engaging	Ensure Door is shut and handle is latched. Check the Door Switch for continuity with Door closed. Check the butt splices and wire connection terminals for good crimps.
	Chamber Pressure Switch	Switch is normally closed. Check the Chamber Pressure Switch for continuity.

# FLOW-DIAGRAM REFERENCE TROUBLESHOOTING CHART

REF LETTER	POSSIBLE CAUSE	EVALUATION
<b>I</b>	Time Delay Relay #1 (5 sec)	Relay is normally open. Check for continuity during the first 5 -10 seconds of pressing PWR ON button.
	Control Relay #2	Check for 24-30VDC at Pins 7 & 8 on the CR2 Coil. Check for 24VAC on pin 3. Ensure Relay Contacts are closing and not stuck open.
	Blower Pressure Switch	Switch is normally open. Check that switch closes at .2” Water Column (WC) & that voltage is present on Lt Blue wire to Ignition Module at pin PSW.
	Power Burner Blower	Check that the vent is set for: <b>3” for Natural Gas &amp; 3” for Propane.</b> If vent is to large, then unit will <u>not ignite</u> .
	Ignition (Spark) Module	Check the Red LED light on the module for the following indications (listed on the module): <b>Constant = Control Fault</b> (Turn unit OFF & back ON, if LED goes out; then ignition module is OK.) <b>1 Flash = Air Vent Blockage / No Blower Pressure</b> <b>2 Flashes = Flame with No Call For Heat</b> <b>3 Flashes = Ignition Lookout (No Gas Present)</b>
	Ignition Probe & Cable	Check that the probes are <u>not</u> oxidized or broken. Check that the Ignition Cable has a good connection to Ignition Probe. Verify that the Ignition Probes are in the correct position to the Burner’s surface as required.
	Gas Enrichment Valve	Check to ensure that the Time Delay Relay #2 is opening the Gas Enrichment Valve for 4 seconds. (Signal from Spark Module out of pin V1.)
	Gas Valve Control	Ensure that the valve is engaging. Check that the Gas Pressure is at the correct WC value: <b>5” for Natural Gas &amp; 10” for Propane.</b>
	External Supply Gas Press. Regulator	Verify that the incoming gas pressure from the External Regulator is between WC values: <b>7” - 10” Natural Gas &amp; 11” - 13” Propane.</b>
	Steam Vent Blocked	Steam should be coming out of vent at back of steamer. Check for blockage in the vent, which can cause the Chamber Pressure Switch to <u>open</u> . Ensure that there is at least a minimum of 1/4” slope for every foot added, of extended exhaust piping. Ensure that any extended exhaust piping is made of galvanized or stainless steel, or copper; and a minimum of 3/4” in diameter. If blockage is present, try to pour some hot water down the vent piping to unclog the blockage ( <i>may have to blow out the blockage if water doesn't help</i> ).
<b>J</b>	Steam Temperature Is <u>Not</u> At Desired Cook Temperature	Check that the Door is closed and no steam is escaping from it. Verify that Low Water indicator light is <u>not</u> lit. Check that steamer is in the COOK mode and <b>NOT</b> in the HOLD mode.

# FLOW-DIAGRAM REFERENCE TROUBLESHOOTING CHART

REF LETTER	POSSIBLE CAUSE	EVALUATION
<b>J</b>	Steam Vent Blocked	<i>See Ref Letter I.</i>
<b>K</b>	Door Assembly	Check to see if the Door is seating completely around the face of the Steamer. Check that the Door Gasket does <u>not</u> have any cuts, nicks, debris, or discolorations ( <i>white or grey</i> ).
	Pressure Switch	Check that the Chamber Pressure Switch opens and closes checking the Ohms reading while blowing into its input hose. ( <i>Disconnect the hose from the chamber inlet hole.</i> )
	Steam Vent Blocked	<i>See Ref Letter I.</i>
<b>L</b>	Food Cook Time Too Long	Ensure that the proper Cook Time is being used. <b>Refer to the Owners Manual for cooking tips if no mechanical reason is found for this symptom.</b>
<b>M</b>	Food Cook Time <u>Not</u> Long Enough	<i>See Ref Letter K.</i> Ensure that the steamer is in the COOK mode and <u>not</u> the HOLD mode. ( <i>HOLD has a preset temp value that is below that of 212°F</i> ) Check that proper pan placement is being utilized for best cooking conditions. ( <i>See Owners Manual</i> ) Ensure that the Drain Ball-Valve is shut tightly or possible loss of heating efficiency. <b>Refer to the Owners Manual for cooking tips if no mechanical reason is found for this symptom.</b>

## NOTE

**If your symptoms are not listed in the Flow Chart and/or the REF Chart, then additional troubleshooting may be required.**

**If you need additional ideas for troubleshooting or want to confirm your symptoms with one of our Service Techs, please contact us by phone or e-mail listed below with the unit's S/N or Model information.**

**AccuTemp Service Dept. Phone   (800) 480-0415**

**AccuTemp Service Dept. Email   service@accutemp.net**



# LOCATION OF ELECTRICAL COMPONENTS

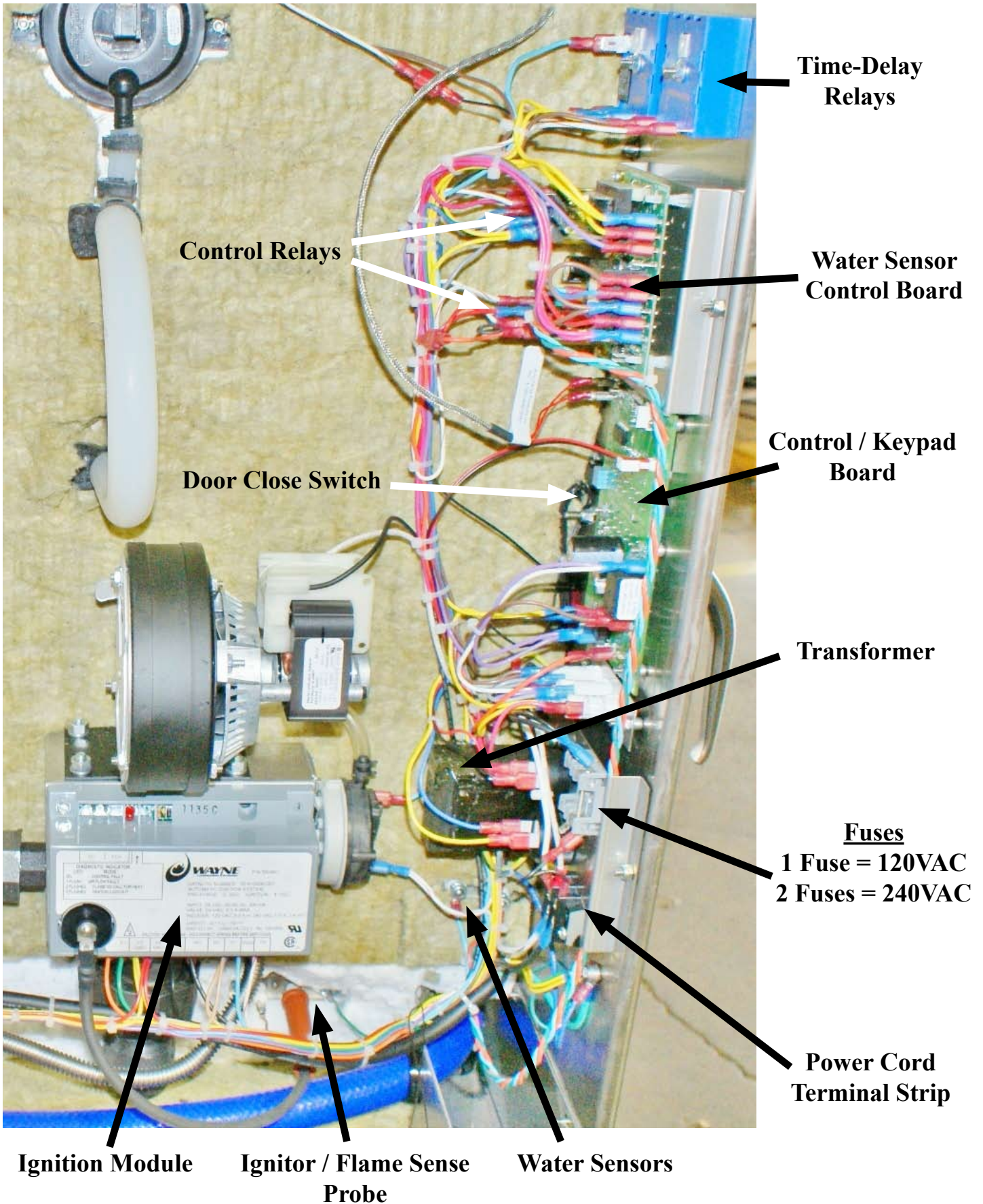

# ELECTRICAL COMPONENTS REMOVAL & INSTALLATION

## CORD & PLUG ASSEMBLY

1. Unplug the Unit.
2. Remove the Left-Side Panel by removing the Sheet Metal Screws holding it in place.
3. Disconnect the Power Cord Leads (Black, White, Red, and/or Green) from the Terminal Strip.
4. On the inside of the unit, remove the retaining nut on the threads of the Power Cord Cable Fitting & pullout the Power Cord.
5. **Re-install in reverse order.**



## WATER SENSOR CONTROL BOARD

1. Unplug the Unit.
2. Remove the Left-Side Panel by removing the Sheet Metal Screws holding it in place.
3. Disconnect the wires (note the wire color to its location pin).
4. Carefully, push in the locking leg on the 4 plastic posts while pulling the Water Board up off the posts (note the board's orientation).
5. Remove the Water Board.
6. **Re-install in reverse order.**



## WATER SENSORS

1. Unplug the Unit.
2. Remove the Left-Side Panel by removing the Sheet Metal Screws holding it in place.
3. Open the door and ensure that all the water is drained from the steam chamber.
4. Disconnect the wire from the backside of the Water Sensor (access via left-side panel).
5. Remove the retaining nut that mounts the Water Sensor to the Steam Chamber.
6. Push the Water Sensor through the hole in the steam chamber from the backside.
7. **Re-install in reverse order. Torque Sensor Nuts to between 12-15 In-Lbs.**





# ELECTRICAL COMPONENTS REMOVAL & INSTALLATION

## TRANSFORMER

1. Unplug the Unit.
2. Remove the Left-Side Panel by removing the Sheet Metal Screws holding it in place.
3. Disconnect the wires (note the wire color to its location terminal).
4. Remove the 2 mounting nuts and then remove the Transformer.
5. **Re-install in reverse order.**

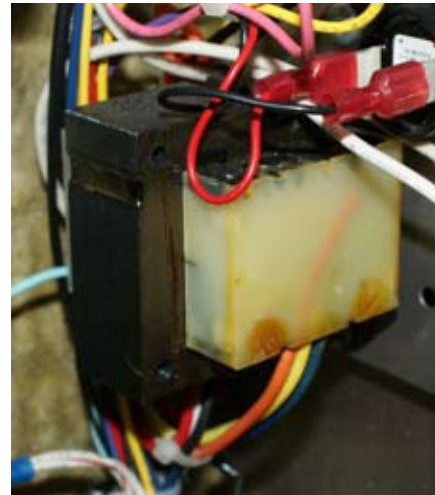

## TEMPERATURE (RTD) SENSOR

1. Unplug the Unit.
2. Remove the Left-Side, Right-Side, and Top Panel by removing the Sheet Metal Screws holding it in place.
3. Disconnect the probe wires from the Control/Keypad Panel and pull them from the left, over the top, to the steamer's right-side (the wires to the location pins are enter-changeable).
4. Remove the mounting nut and then remove the Temperature (RTD) Sensor.
5. **Re-install in reverse order. Ensure Thermal Paste is applied to the Temperature (RTD) Sensor.**



## CONTROL / KEYPAD BOARD

1. Unplug the Unit.
2. Remove the Left-Side Panel by removing the Sheet Metal Screws holding it in place.
3. Disconnect the wires (note the wire color to its location terminal).
4. Remove the 7 mounting nuts and then remove the Control Panel CCA.
5. *(If accessing the Program Mode is needed, go to **page 10** for more details.)*
6. **Re-install in reverse order.**





# ELECTRICAL COMPONENTS REMOVAL & INSTALLATION

## OVERTEMP SWITCH (THERM LIMIT SW3)

1. Unplug the Unit.
2. Remove the Left-Side Panel by removing the Sheet Metal Screws holding it in place.
3. Disconnect the wires (note the wire color to its location pin).
4. Remove the 2 mounting screws and then remove the Overtemp Switch.
5. **Re-install in reverse order.**



## IGNITION MODULE

1. Unplug the Unit.
2. Remove the Left-Side Panel by removing the Sheet Metal Screws holding it in place.
3. Remove the mounting nut on the Ignition Cable.
4. Disconnect the wires (note the wire color to its location pin).
5. Remove the 2 mounting screws and then remove the correct voltage type Control Relay.
6. **Re-install in reverse order.**



## TIME-DELAY RELAYS

1. Unplug the Unit.
2. Remove the Left-Side Panel by removing the Sheet Metal Screws holding it in place.
3. Disconnect the wires from the desired Time-Delay Relay (note the wire color to its location pin).
4. Remove the mounting nut and then remove the desired Time-Delay Relay.
5. *(Ensure the time-delay pot is set to the correct delay time...TDR#1 = 5sec / TDR#2 = 4sec).*
6. **Re-install in reverse order.**

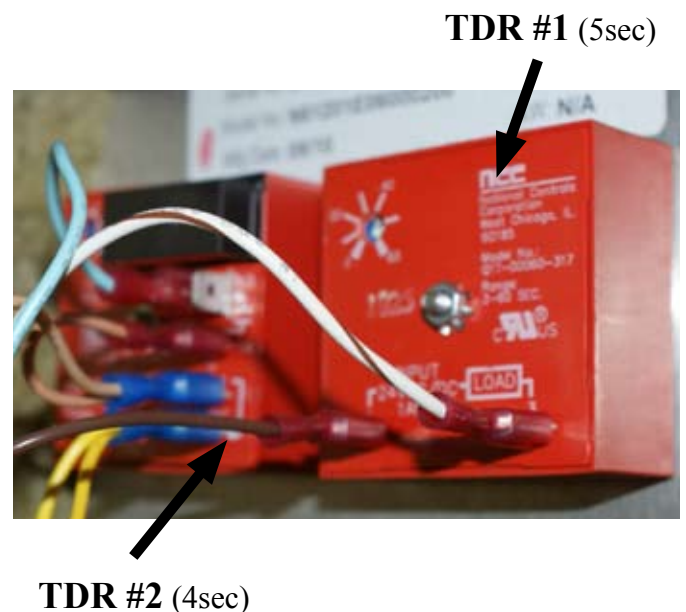

# ELECTRICAL COMPONENTS REMOVAL & INSTALLATION

## CHAMBER PRESSURE SWITCH

1. Unplug the Unit & remove the Left-Side Panel by removing the Sheet Metal Screws holding it in place.
2. Disconnect the Wiring Terminals from the Chamber Pressure Switch (note the wire color to its location terminal).
3. Remove the hose clamp and disconnect the hose from the Chamber Pressure Switch.
4. Remove the 2 mounting nuts holding the Chamber Pressure Switch to chamber cavity.
5. Remove the Chamber Pressure Switch
6. **Re-install in reverse order.**



## CONTROL RELAYS

1. Unplug the Unit.
2. Remove the Left-Side Panel by removing the Sheet Metal Screws holding it in place.
3. Disconnect the wires (note the wire color to its location pin).
4. Remove the 2 mounting screws and then remove the correct voltage type Control Relay.
5. **Re-install in reverse order.**

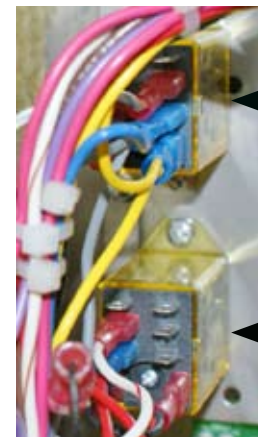

AC Relay  
CR1

DC Relay  
CR2

## IGNITOR & FLAME SENSE PROBE

1. Unplug the Unit.
2. Remove the Left-Side Panel by removing the Sheet Metal Screws holding it in place.
3. Disconnect the wires from the probes (note the wire to its probe location).
4. Remove the 2 mounting bolts and then remove the Probe Assembly.
5. **Re-install in reverse order. Ensure that the GND Probe is angled towards the Burner's Surface.**

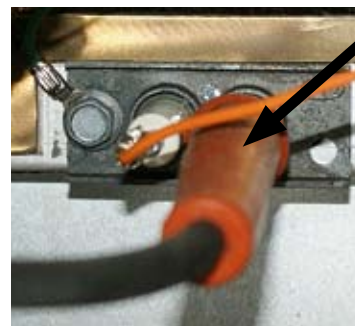

Ignition  
Probe

Flame  
Sense  
Probe

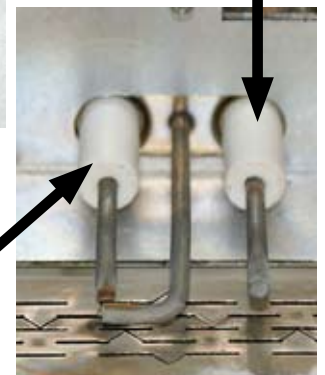

Ignition  
Probe

# ELECTRICAL COMPONENTS REMOVAL & INSTALLATION

## DOOR SWITCH

### *Door Latch on the Left-Hand Side*

1. Unplug the Unit.
2. Remove the Left-Side Panel by removing the Sheet Metal Screws holding it in place.
3. Disconnect the probe wires: Control/Keypad Panel J7 Pin 1 & the White/Brown wire from the Chamber Pressure Switch (the wires to the location pins are enter-changeable).
4. Push back the insulation, so you can access the other mounting nut to be removed.
5. Remove the 2 mounting nuts and then remove the Door Switch. ***Fg 1***
6. **Re-install in reverse order.**

***Fg 1***

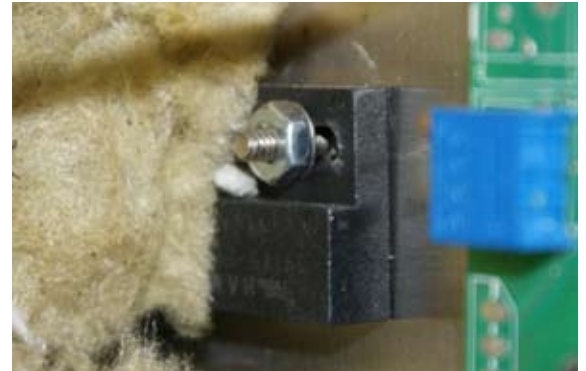

### *Door Latch on the Right-Hand Side*

1. Unplug the Unit.
2. Remove the Left-Side, Right-Side, and Top Panel by removing the Sheet Metal Screws holding it in place.
3. Disconnect the probe wires: Control/Keypad Panel J7 Pin 1 & the White/Brown wire from the Chamber Pressure Switch; and pull the wires up, over the top of the steamer (the wires to the location pins are enter-changeable).
4. Remove the insulation on the right side, to access the Door Switch to be removed. ***Fg 2***
5. Remove the 2 mounting nuts and then remove the Door Switch. ***Fg 3***
6. **Re-install in reverse order.**

***Fg 2***



***Fg 3***



## FUSES

1. Unplug the Unit.
2. Remove the Left-Side Panel by removing the Sheet Metal Screws holding it in place.
3. Pry the Fuse(s) out of the Fuse Block with a flat-head screwdriver or fuse puller.  
1 Fuse = 120VAC & 2 Fuses = 240VAC
4. **Re-install in reverse order.**





# LOCATION OF GAS COMPONENTS

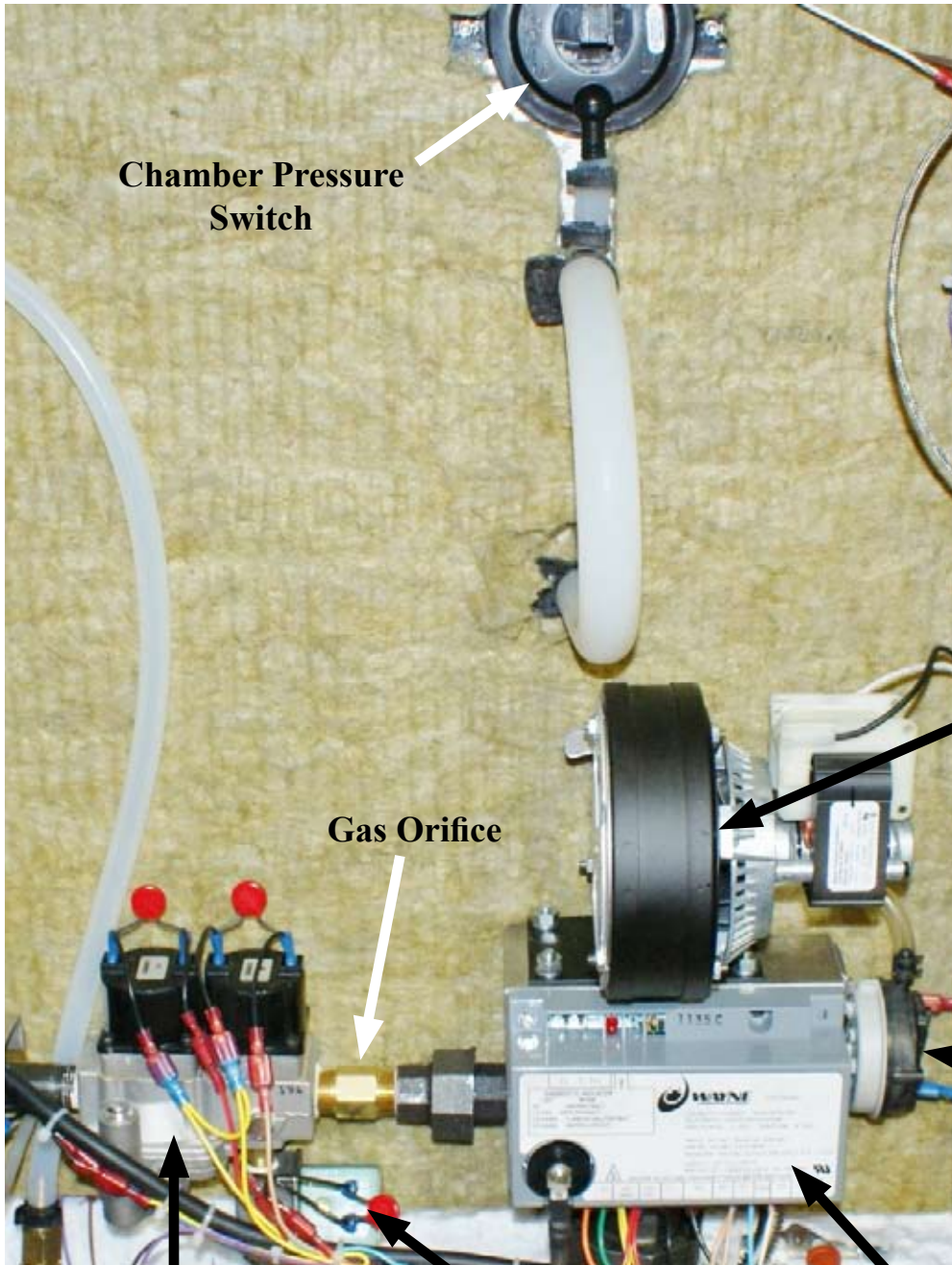

**Chamber Pressure Switch**

**Power Burner Blower**

**Gas Orifice**

**Power Burner Blower Pressure Switch**

**Gas Control Valve**

**Gas Enrichment Valve**

**Ignition Module**

# GAS COMPONENTS REMOVAL & INSTALLATION

## POWER BURNER BLOWER

1. Unplug the Unit & remove the Left-Side Panel by removing the Sheet Metal Screws holding it in place.
2. Disconnect the Wiring Terminals from the Fan (*note wire color location to the Fan's wires*).
3. Disconnect the Blower Pressure Switch Hose from the bottom of the Power Burner Blower.
4. Remove the 4 mounting nuts at Blower base.
5. Remove the Power Burner Blower.
6. **Re-install in reverse order.**

**Ensure the Blower's Air Shutter is set as follows: Natural = 3" & Propane = 3"**



**Fan Pressure Switch Hose**

## GAS CONTROL VALVE

1. Shut OFF the Supply Gas Valve & disconnect the Supply Gas Hose.
2. Unplug the Unit & remove the Left-Side Panel.
3. Disconnect the Gas Line from the Enrichment Valve to the Burner. ***Fig A***
4. Disconnect the Wiring Terminals from the Gas & Enrichment Valves (*note wire color location to each valve's wires*).
5. Disconnect the Union Coupler on the output (right-hand) side of the unit's Gas Valve.
6. Loosen the Retaining Bracket of the Inlet Gas Pipe (left side of Gas Control Valve). ***Fig B***
7. Disconnect the Gas Control Valve's Inlet Gas Pipe.
8. Remove the Gas Orifice & Gas Union Coupler.
9. Remove the Gas Enrichment Valve.
10. **Re-install in reverse order. Ensure Sealant is re-applied to all pipe threading.**

***Fig B***

***Fig A***



**Inlet Gas Pipe**

**Union Coupler**

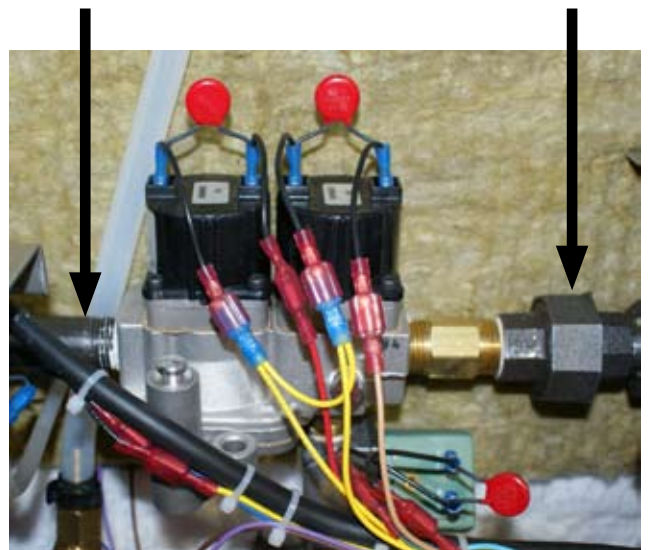

**After Replacing Gas Valves, it is Mandatory to Check and Verify that the Gas Valve has the Proper Water Column (WC) Value Measured with a Manometer. Also Confirm No Gas Leaks Are Present.**



# GAS COMPONENTS REMOVAL & INSTALLATION

## GAS ENRICHMENT VALVE

1. Shut OFF the Supply Gas Valve & disconnect the Supply Gas Hose.
2. Unplug the Unit & remove the Left-Side Panel by removing the Sheet Metal Screws holding it in place.
3. Disconnect the Gas Line from the Enrichment Valve to the Burner. ***Fig A***
4. Disconnect the Wiring Terminals from the Enrichment Valve (note wire color location to the valve's wires).
5. Disconnect and remove the Enrichment Valve from under the unit's Gas Control Valve.
6. Remove the 90° elbow.
7. Remove the MOV Wires (*note their location on the Enrichment Valve*).
8. **Re-install in reverse order. Ensure Sealant is re-applied to all pipe threading.**



**After Replacing Gas Enrichment Valve, it is Mandatory to Check and Verify that the Gas Valve has the Proper Water Column (WC) Value Measured with a Manometer. Also Confirm No Gas Leaks Are Present.**



## POWER BURNER BLOWER PRESSURE SWITCH

1. Unplug the Unit & remove the Left-Side Panel by removing the Sheet Metal Screws holding it in place.
2. Disconnect the Wiring Terminals from the Power Burner Blower Pressure Switch (*note wire color location to the switch's wires*).
3. Remove the hose clamp and disconnect the hose to the Power Burner Blower Pressure Switch.
4. Remove the 2 mounting screws on the Power Burner Blower Pressure Switch mounting bracket.
5. Remove the 3 screws holding the Power Burner Blower Pressure Switch to the mounting bracket.
6. Remove the Power Burner Blower Pressure Switch.
7. **Re-install in reverse order.**



# GAS COMPONENTS REMOVAL & INSTALLATION

## GAS ORIFICES

1. Shut OFF the Supply Gas Valve & disconnect the Supply Gas Hose.
2. Unplug the Unit & remove the Left-Side Panel.
3. Disconnect the Gas Union Coupler on the output (right) side of the Gas Control Valve.
4. Loosen the Retaining Bracket of the Inlet Gas Pipe (left side of Gas Control Valve). ***Fig B***
5. Remove the Gas Union Coupler Fitting from the Gas Orifice.
6. Remove the Gas Orifice from the Gas Control Valve.
7. Disconnect the Burner Union Coupler below the Ignition Module. ***Fig C***
8. Pull-out the Ignition Module Bracket and angle it to allow access to the end of the Gas Enrichment Valve Hose, attached to the piping behind the Ignition Module Bracket. ***Fig D***
9. Detach the Gas Enrichment Hose fitting to allow access to the Gas Enrichment Orifice.
10. Remove the Gas Enrichment Orifice from the Gas Enrichment Hose fitting. ***Fig E***
11. **Re-install in reverse order. Ensure Sealant is re-applied to all pipe threading.**

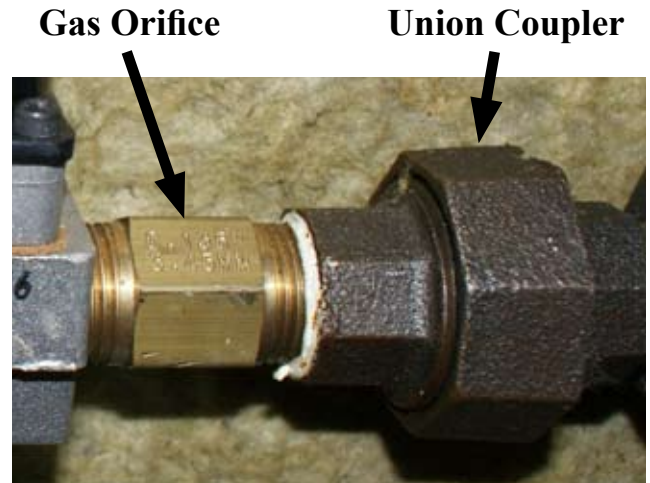

***Fig C***

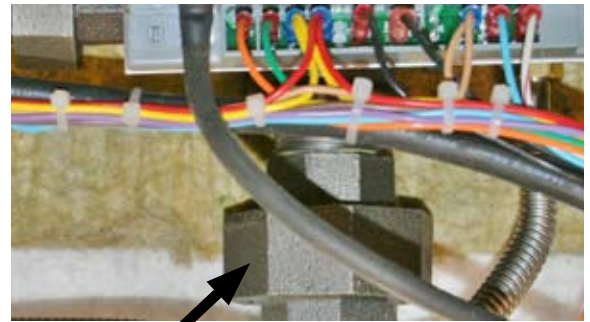

**Burner Union Coupler**

***Fig D***



**Gas  
Enrichment  
Hose End  
Fitting**

***Fig E***

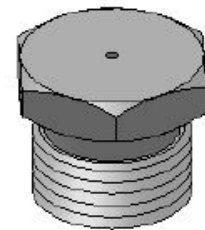

**USE THE GAS ORIFICE PER  
ALTITUDE CHART, ON PAGE 40, TO  
ENSURE THE PROPER ORIFICE  
SIZES IS USED.**

**After Replacing Gas Orifices, it is  
Mandatory to Check and Verify that the  
Gas Valve has the Proper Water Column  
(WC) Value Measured with a Manometer.  
Also Confirm No Gas Leaks Are Present.**

# LOCATION OF GAS BURNER & GAS BURNER BOX

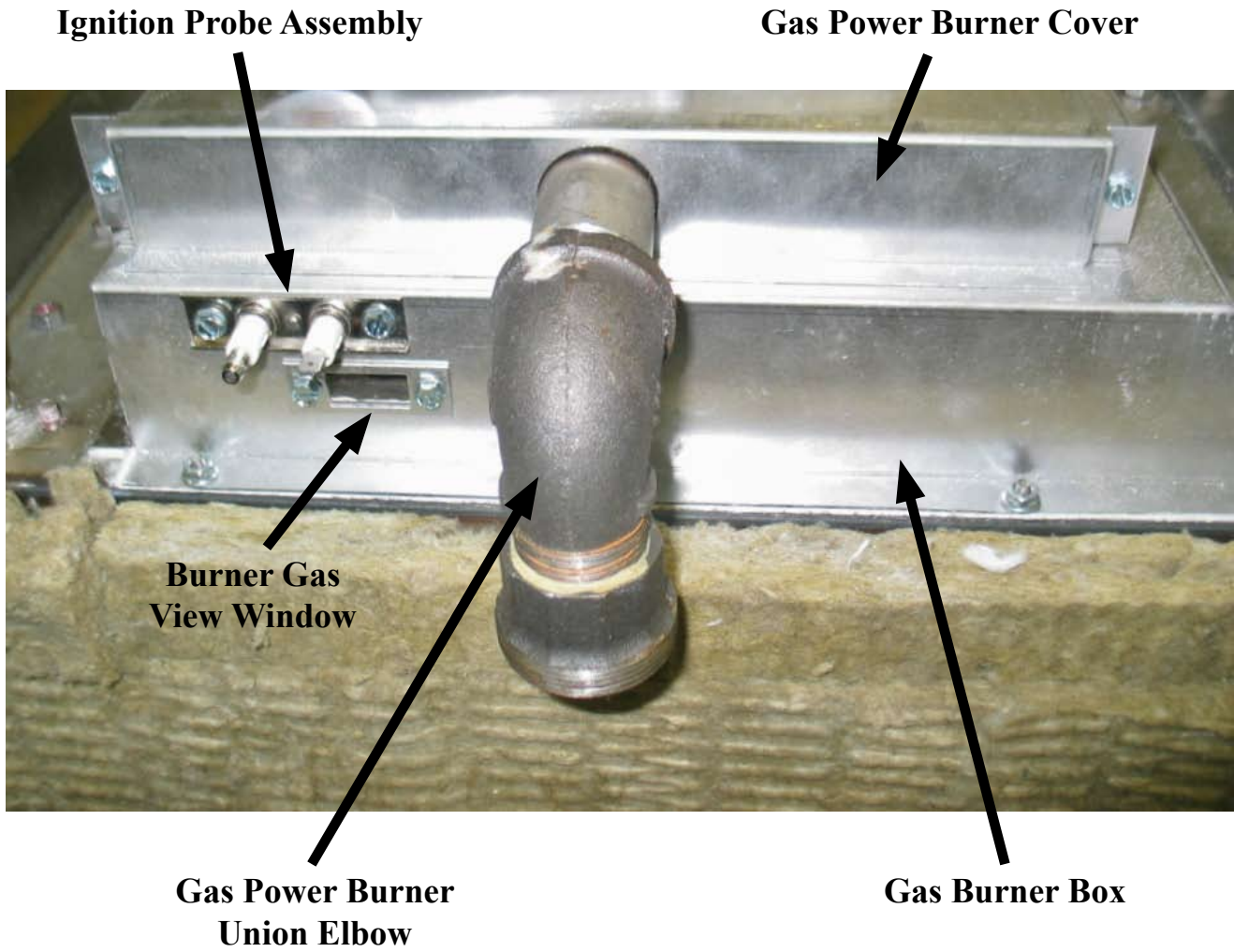



# GAS POWER BURNER REMOVAL & INSTALLATION

## GAS POWER BURNER

1. Shut OFF the Supply Gas Valve & disconnect the Supply Gas Hose & Unplug the unit.
2. Turn the unit upside-down and remove its legs. (*Unbolt from stand and then turn unit upside-down if applicable.*)
3. Remove Left-Side Panel & Bottom Cover. (*Remove Drain Pan Rails if applicable.*)
4. Remove the Ignition Probe Sensor Bracket's 2 screws. (*Note the orientation of the Ignition Probe in ref to the Gas Burner Union Coupler.*)
5. Remove the Insulation as needed to provide access to remove the Gas Burner from its Gas Burner Box. (*Note the insulation location for proper fitting when re-installed.*)
6. Disconnect the Gas Burner Union Coupler.
7. Remove the 2 mounting screws from Gas Burner's support bracket.
8. Remove the Gas Power Burner by sliding it out of the Gas Burner Box.
9. **Re-install in reverse order.**



**After Replacing Gas Burner, it is Mandatory to Check and Verify that the Gas Valve has the Proper Water Column (WC) Value Measured with a Manometer. Also Confirm No Gas Leaks Are Present.**

**Ignition Probe Bracket**

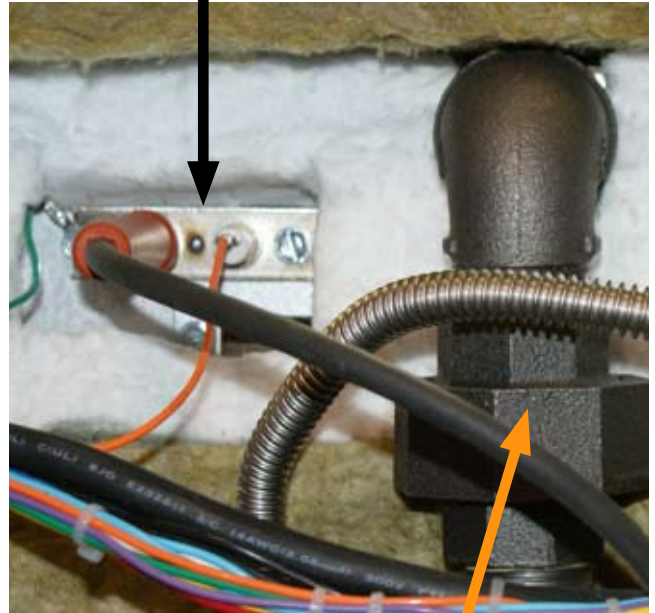

**Burner Union Coupler**

**Gas Burner Cover**

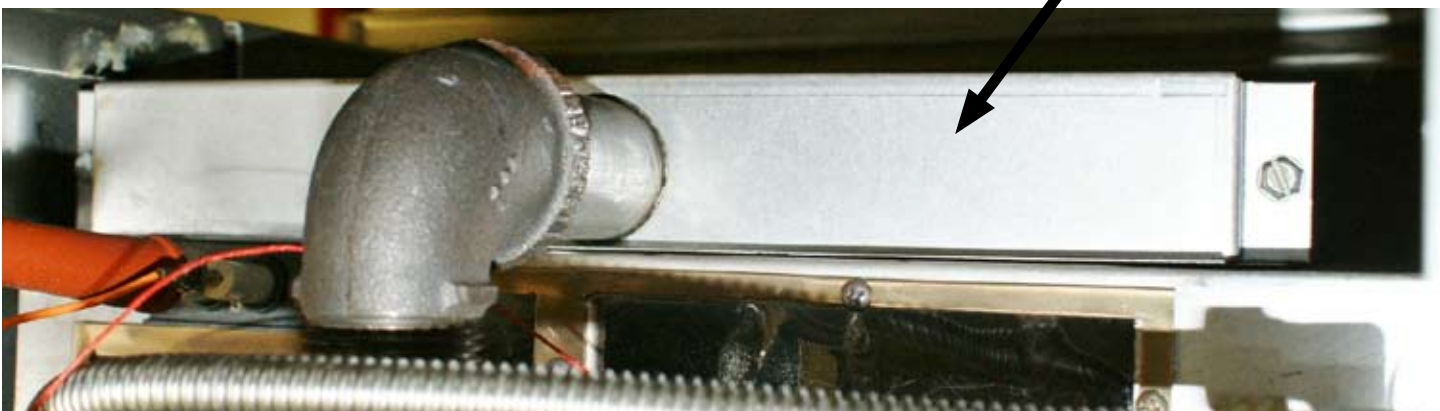

# GAS POWER BURNER BOX REMOVAL & INSTALLATION

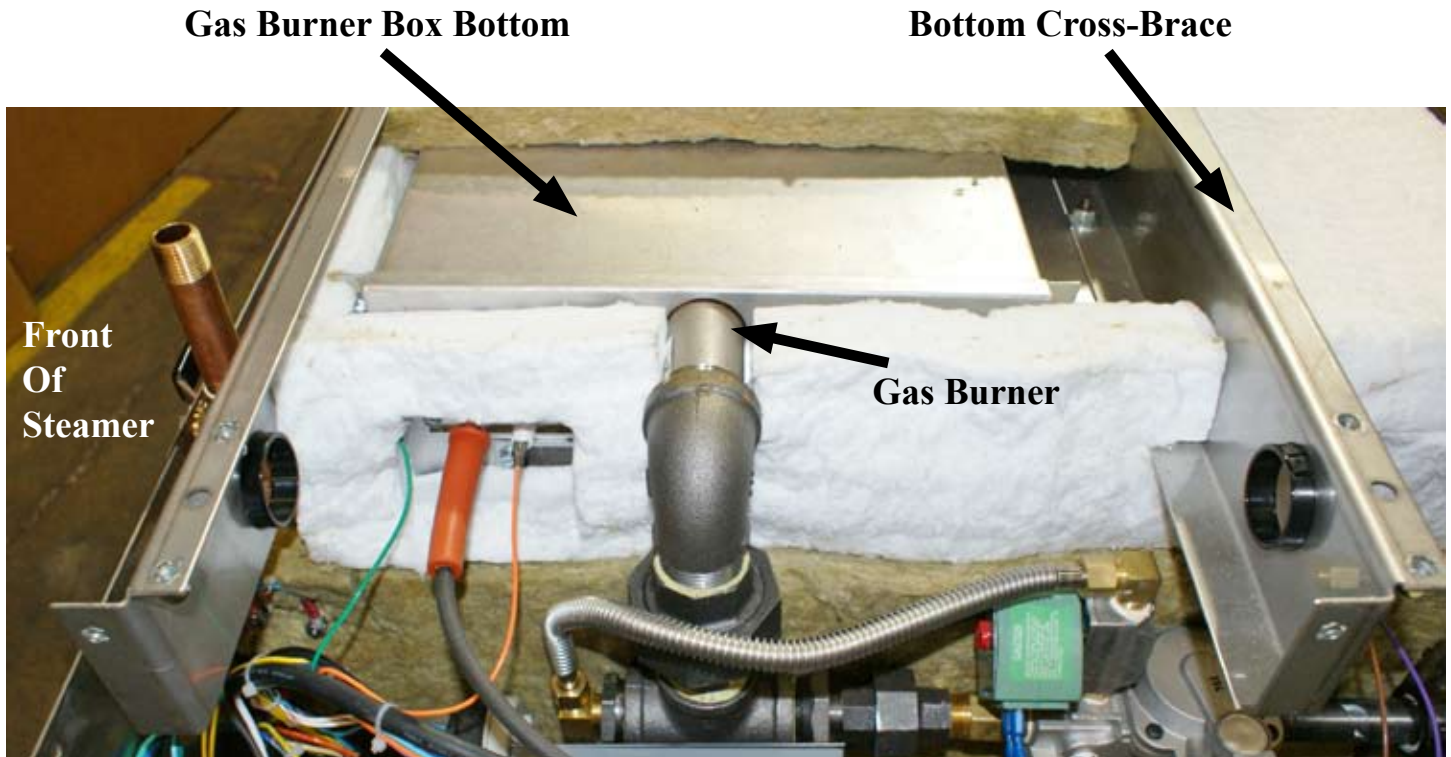

GAS POWER BURNER BOX

Fig F

1. Shut OFF the Supply Gas Valve & disconnect the Supply Gas Hose & Unplug the unit.
2. Turn the unit upside-down and remove its legs. (*Unbolt from stand and then turn unit upside-down if applicable.*)
3. Remove Left-Side Panel & Bottom Cover by removing the Sheet Metal Screws holding it in place. (*Remove Drain Pan Rails if applicable.*)

Fig F



Fig G

4. Remove the Ignition Probe Sensor Bracket's 2 screws. (*Note the orientation of the Ignition Probe in ref to the Gas Burner Union Coupler.*)
5. Remove the Insulation as needed to provide access to remove the Gas Burner Box. (*Note the insulation location for proper fitting when re-installed.*) Fig G
6. Disconnect the Burner Union Coupler.
7. Remove the 2 mounting screws from Gas Burner's support bracket.
8. Remove the Gas Burner by sliding it out of the Gas Burner Box.





# GAS POWER BURNER BOX REMOVAL & INSTALLATION

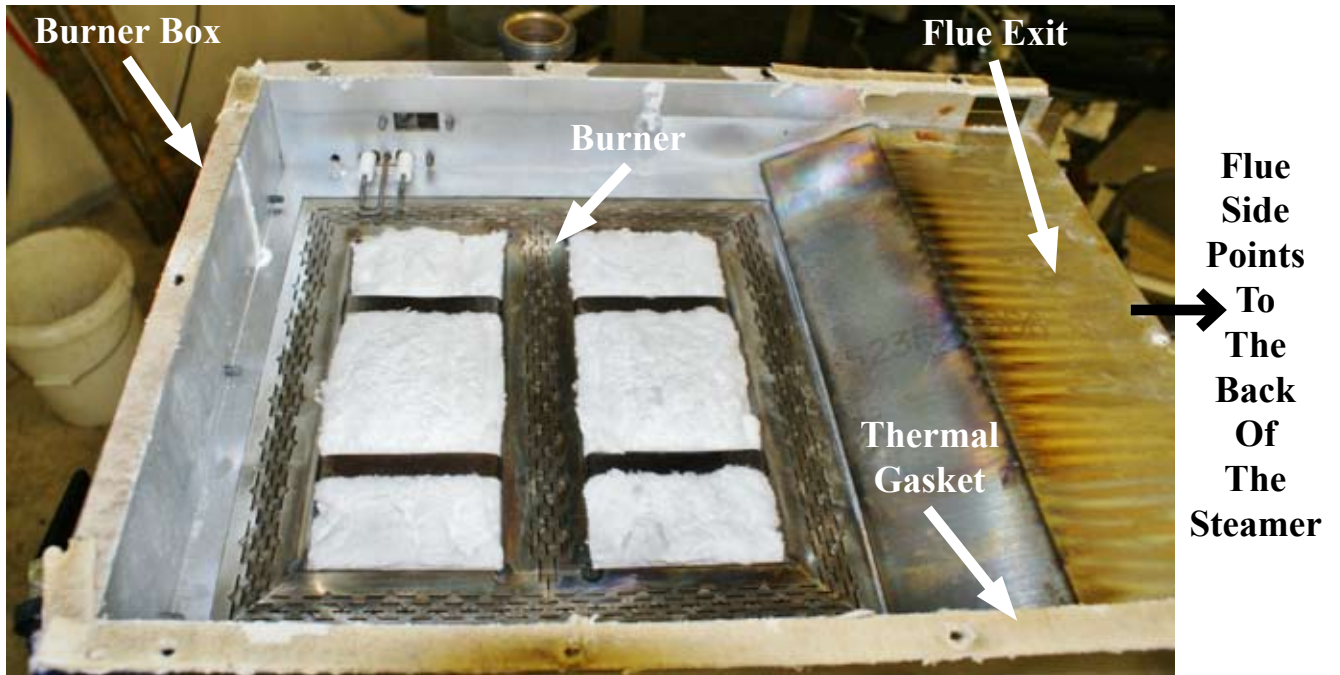

## GAS POWER BURNER BOX (CON'T)

9. Unscrew the PWR Cord retaining fitting on the Back Panel and pull some slack through the fitting, to allow for some room to remove the Back Panel.
10. Unscrew the Back Panel's sheet metal screws and remove the Back Panel.
11. Remove the 2 bottom structural cross-braces.
12. Remove the mounting nuts on the Flue and the Burner Box.
13. Remove the Exhaust Flue off the Gas Burner Box. ***Fig H***
14. Lift and remove the Burner Box. (*Might have to use a flat-head screwdriver to pry up the Gas Burner Box from the Gas Burner Gasket.*)
15. Re-install in reverse order.

## ***Prior to installing the new Burner Box:***

- Scrap, remove, and clean-off any remaining Gas Burner Gasket residue from the steamer's bottom (where the mounting studs are located).
- Apply the 3 new Gas Burner Gaskets to the Bottom of the Gas Burner Box.  
**Side Gaskets = AT1I-3771-4 (Need 2)**  
**Front Gasket = AT1I-37771-3**

***Fig H***

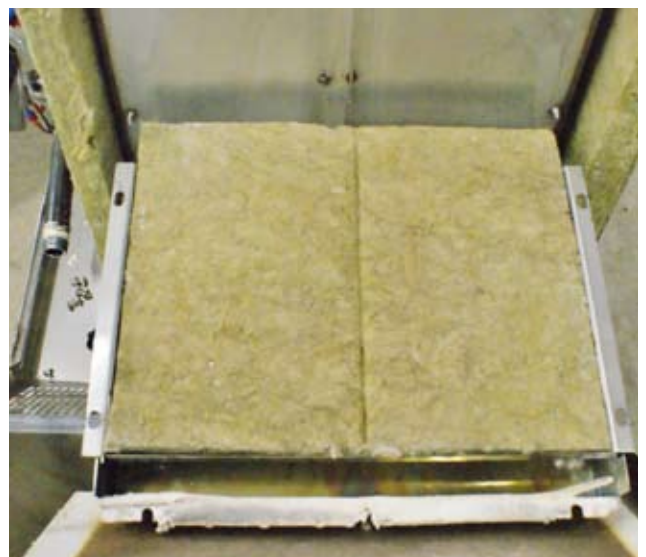

**After Replacing Burner Box, it is Mandatory to Check and Verify that the Gas Valve has the Proper Water Column (WC) Value Measured with a Manometer. Also Confirm No Gas Leaks Are Present.**

## LOCATION OF HEAT TRANSFER PLATE

### NOTE

**The Zinc Flat Washer, Lock Washer, and 1/4-20# Nut Can Only Be Used Once. Ensure That New Zinc Hardware is Ordered (Minimum of 24 Each Required) and Received; Prior to Removing or Installing the Heater Transfer Plate.**

**Zinc 1/4-20# Nut = AT0F-2778-51002  
Zinc 1/4" Flat Washer = AT0F-1052-51002  
Zinc 1/4" Lock Washer = AT0F-2666-51002**

Heat Transfer Plate

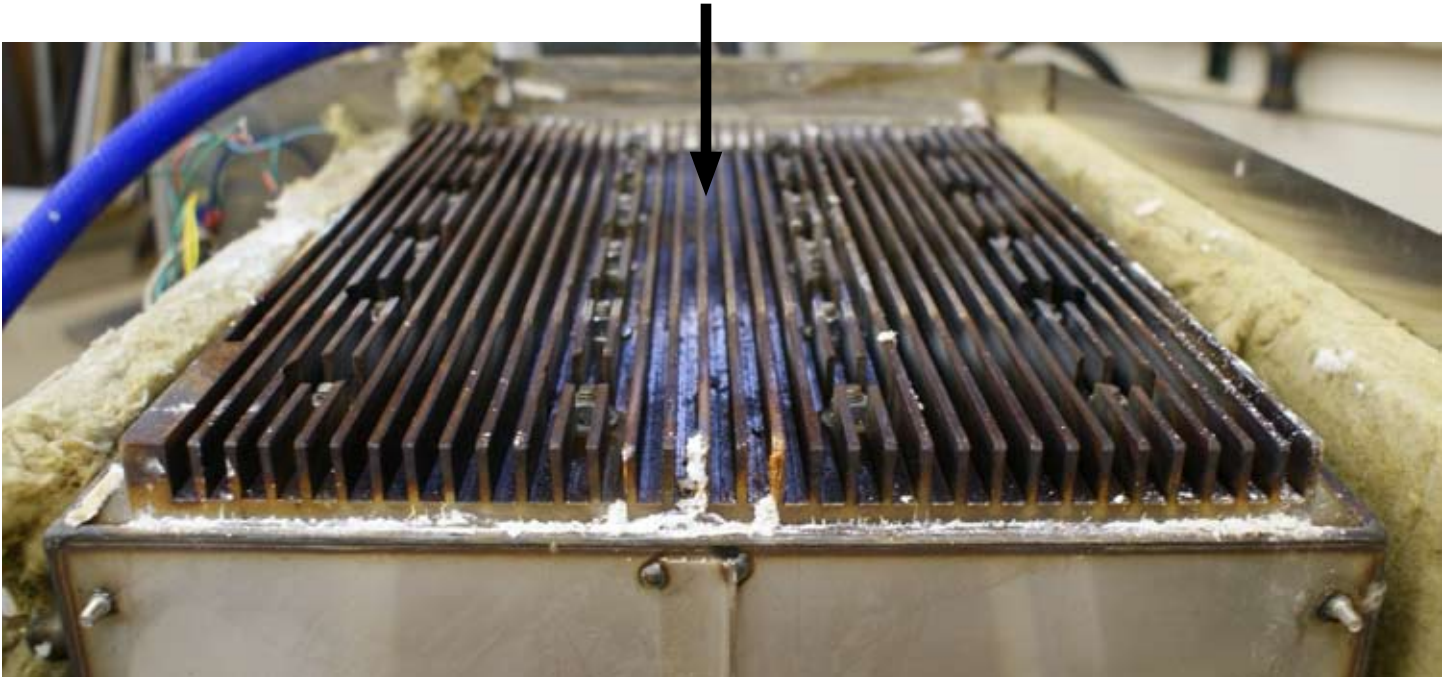

### NOTE

**Ensure That Thermal Joint Compound is Ordered (Minimum Of 2 Required) and Received, Prior to Removing or Installing the Heater Transfer Plate.**

**Thermal Joint Compound = AT0H-3412-2**



# HEAT TRANSFER PLATE REMOVAL & INSTALLATION

## HEAT TRANSFER PLATE

1. Shut OFF the Supply Gas Valve & disconnect the Supply Gas Hose & Unplug the unit.
2. Turn the unit upside-down and remove its legs. (*Unbolt from stand and then turn unit upside-down if applicable.*)
3. Remove Left-Side Panel & Bottom Cover by removing the Sheet Metal Screws holding it in place. (*Remove Drain Pan Rails if applicable.*)
4. Remove the Ignition Probe Sensor Bracket's 2 screws. (*Note the orientation of the Ignition Probe in ref to the Gas Burner Union Coupler.*)
5. Remove the Insulation as needed to provide access to remove the Gas Burner Box. (*Note the insulation location for proper fitting when re-installed.*) **Fig I**
6. Disconnect the Burner Union Coupler.
7. Remove the 2 mounting screws from Gas Burner's support bracket.
8. Remove the Gas Burner by sliding it out of the Gas Burner Box.
9. Unscrew the PWR Cord retaining fitting on the Back Panel and pull some slack through the fitting, to allow for some room to remove the Back Panel.
10. Unscrew the Back Panel's sheet metal screws and remove the Back Panel.
11. Remove the 2 bottom structural cross-braces.
12. Remove the mounting nuts on the Flue and the Burner Box.
13. Remove the Exhaust Flue off the Gas Burner Box. **Fig J**
14. Lift and remove the Gas Burner Box. (*Might have to use a flat-head screwdriver to pry up the Gas Burner Box from the Gas Burner Gasket.*) **Fig K**

**Fig I**



**Fig J**



**Fig K**



# HEAT TRANSFER PLATE REMOVAL & INSTALLATION

## NOTE

**If Heater Studs are Discovered Broken While Removing the Heater Transfer Plate  
OR  
If a Heater Stud Breaks-Off While Removing or Installing the Heater Transfer Plate**

**Call AccuTemp Service Dept (800) 480-0415.**

### HEAT TRANSFER PLATE (CON'T)

15. Using *Fig L*, Loosen all 24 nuts by starting with Zinc Nut #24 and working down to #1.
16. Remove all 24, Zinc Nut, Lock & Flat Washers from the Heat Transfer Plate.
17. Remove the Heat Transfer Plate. (*Might have to use a flat-head screwdriver to pry up the Heater Plate from the Thermal Compound.*)
18. Re-install in reverse order. **SEE NEXT PAGE FOR INSTALLATION NOTES.**

*Fig L*

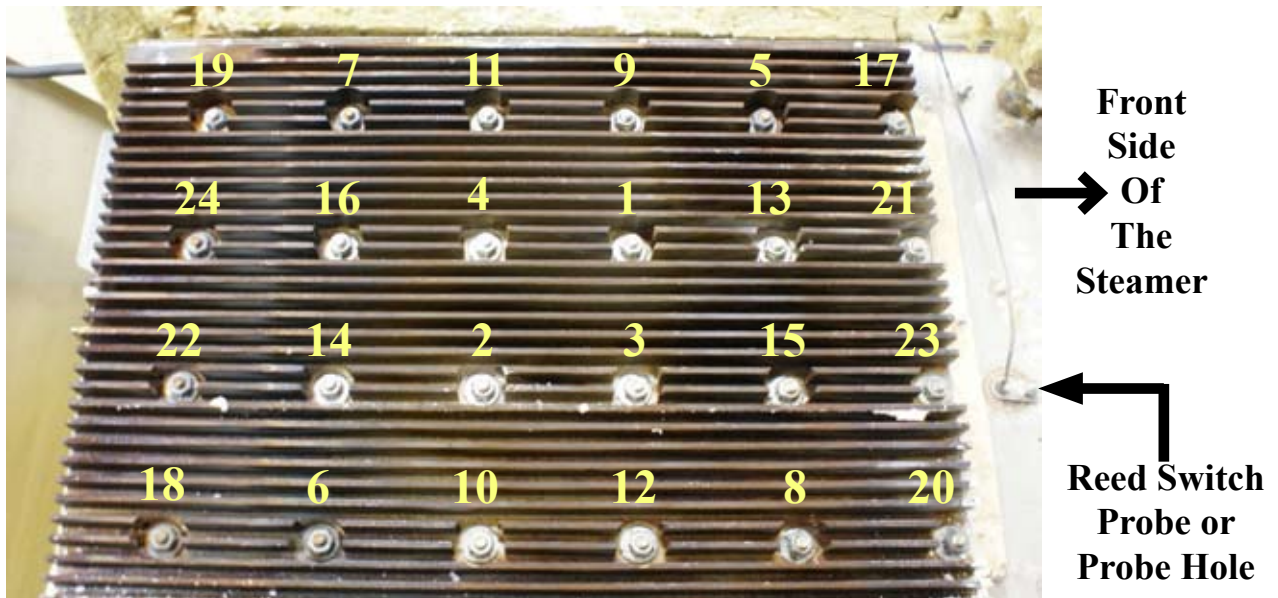

### **Prior to installing the new Heat Transfer Plate:**

- Scrap, remove, and clean-off any remaining Thermal Compound residue from the steamer's bottom (where the mounting studs are).
- Apply Thermal Compound with a Square "D" notch trowel to the new Heat Transfer Plate's flat surface that makes contact with the steam chamber bottom.
- Scrap, remove, and clean off any remaining Gas Burner Gasket residue from the steamer's bottom (where the mounting studs are located).
- Apply the 3 new Gas Burner Gaskets to the Bottom of the Burner Box when re-installing it.  
**Side Gaskets = AT1I-3771-4 (Need 2) & Front Gasket = AT1I-3771-3**

# HEAT TRANSFER PLATE INSTALLATION

## NOTE

The Zinc HEX Nut Needs to be Torqued Between 34 & 40 IN-LBS. Tighten Starting with Zinc Nut #1 and Follow the Numbered Layout Pattern to Nut #24. Tighten Twice in This Pattern.

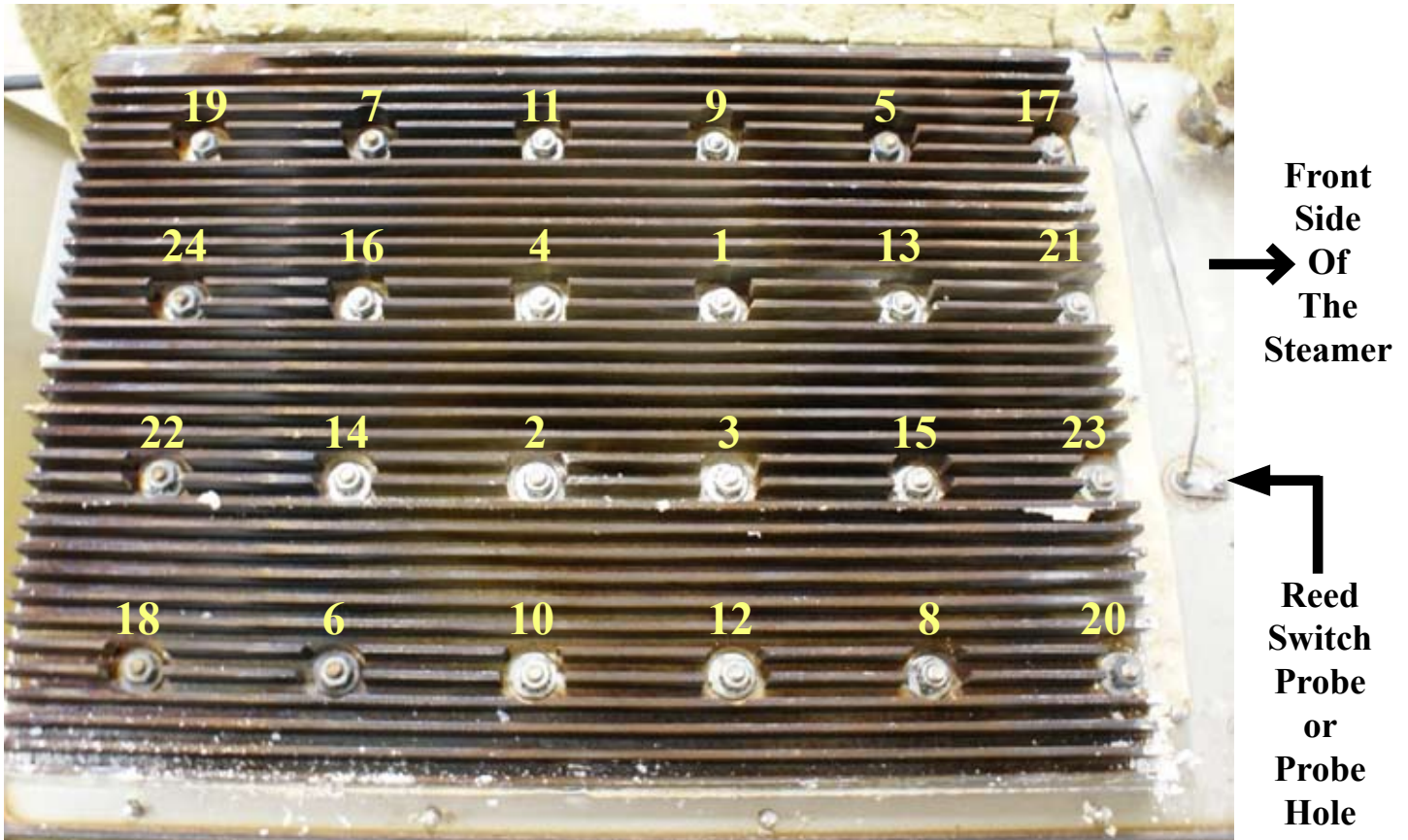

## CAUTION

**DO NOT OVER TORQUE THE ZINC NUTS.**

Over Torquing The Zinc Nuts Can Cause the Studs to Break-Off. This Will Cause Heating Issues; and the Steamer Will Not Operate Correctly or Safely.



After Replacing Heat Transfer Plate, it is Mandatory to Check and Verify that the Gas Valve has the Proper Water Column (WC) Value Measured with a Manometer. Also Confirm No Gas Leaks Are Present.





# MISCELLANEOUS COMPONENTS REMOVAL & INSTALLATION

## AUTO-FILL VALVE

1. Unplug the Unit & drain any remaining water from the steam chamber.
2. Close the supply water valve and disconnect the Supply Water Hose coming into the steamer.
3. Remove the Left-Side Panel by removing the Sheet Metal Screws holding it in place.
4. Disconnect the wires from the Auto-Fill Valve (*note the wire color to its location pin*).
5. Disconnect the Auto-Fill Valve Hose Fitting. **Fig M**
6. On the back of the steamer, remove the 4 mounting screws securing the Auto-Fill Valve bracket on the inside of the steamer.
7. Remove the Auto-Fill Valve.
8. **Re-install in reverse order. Ensure Sealant is re-applied to all pipe threading.**

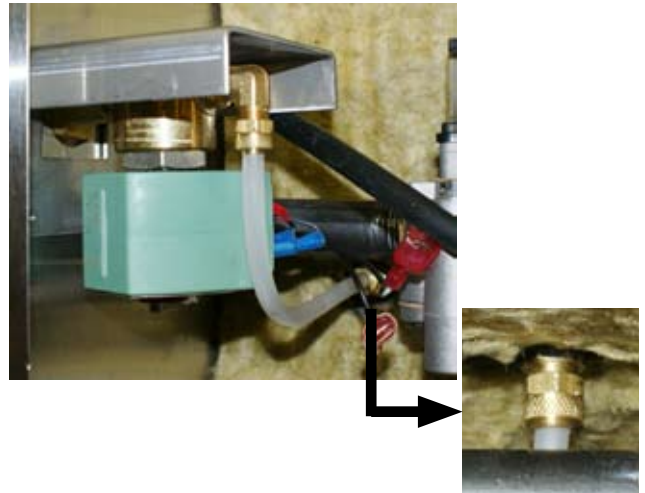

**Fig M**

## OVER-FILL REED SWITCH

1. Unplug Unit & close the supply water valve.
2. Disconnect the garden hose from the back of the steamer & drain any remaining water from the steam chamber.
3. Remove the Left-Side Panel by removing the Sheet Metal Screws holding it in place.
4. Disconnect the REED Switch wires (*note the wire color to its location pin*).
5. Turn the unit upside-down and remove its legs. (*Unbolt from stand and then turn unit upside-down if applicable.*)
6. Remove Bottom Cover by removing the Sheet Metal Screws holding it in place. (*Remove Drain Pan Rails if applicable.*)
7. Remove the front, insulation pieces that are laying on-top of the Over-Fill Reed Switch. (*Wire is ran in-between the insulation pieces.*)
8. Remove the retaining nut and lock washer holding the Reed Switch inside the Sensor Post.
9. Remove the High Water Reed Switch. **Fig N**
10. **Re-install in reverse order.**

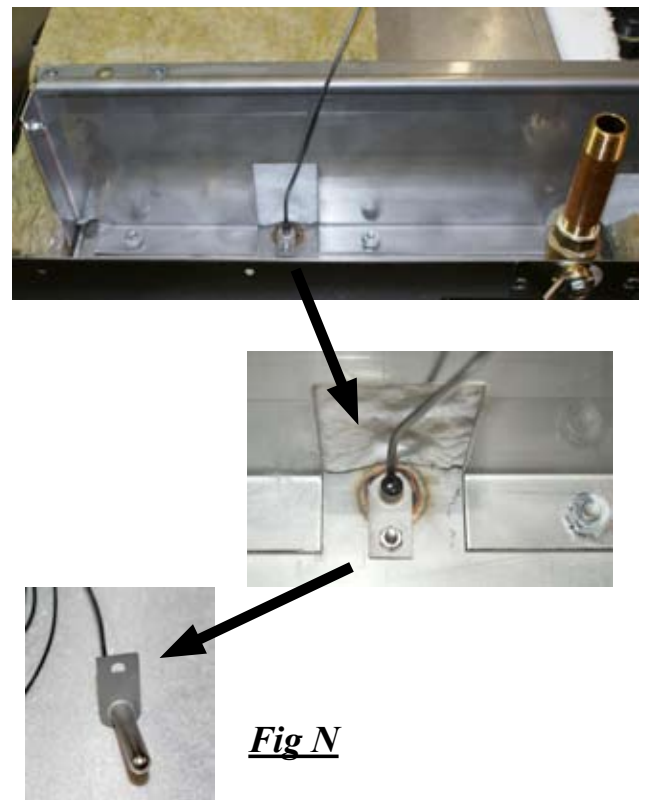

**Fig N**



# MISCELLANEOUS COMPONENTS REMOVAL & INSTALLATION

## FLOAT BALL (MAGNETIC)

1. Open the steamer Door and remove the left-side pan rail.
2. Lift and remove the steam collection cover plate.
3. Remove the Float Ball off of the High Water Reed Switch Sensor Post.
4. **Re-install in reverse order. Ensure Sensor Post & Float Ball hole are clean before re-installing.**



## DRAIN VALVE

1. Unplug the Unit & drain any remaining water from the steam chamber.
2. Turn the unit upside-down and remove its legs. (*Unbolt from stand and then turn unit upside-down if applicable.*)
3. Remove Bottom Cover by removing the Sheet Metal Screws holding it in place. (*Remove Drain Pan Rails if applicable.*)
4. Remove the Drain Handle Cover Plate, and the insulation surrounding the Drain Valve.
5. Remove the Drain Pipe from the Drain Valve.
6. Remove the Drain Valve.
7. **Re-install in reverse order. Ensure Sealant is re-applied to all pipe threading.**

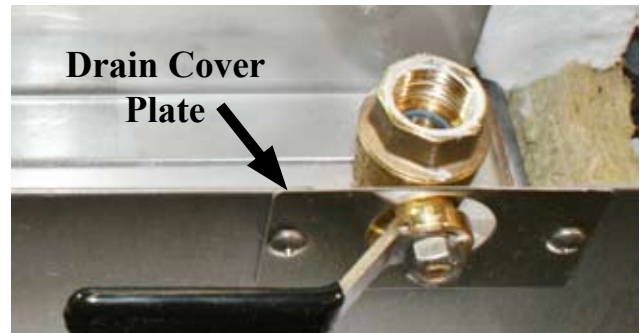

## DRIP PAN

1. Unplug the Unit.
2. Remove the 4 Sheet Metal Screws at the bottom of the Front Panel.
3. Slide the Drip Pan(s) out from between the Front Panel and the Bottom Panel. (*Ensure the split Drip Pans are sloped towards the center of the steamer.*)
4. **Re-install in reverse order.**

**Split Drip Pan**



**Solid Drip Pan**



# DOOR COMPONENTS REMOVAL & INSTALLATION

## DOOR ASSEMBLY

1. Unplug the unit and shut the Door.
2. Remove the Hinge Covers. **Fig O**
3. Remove the 3 hinge screws going into the face of the steamer of the Bottom Hinge. **Fig P**
4. While supporting the Door on the hinge-side, remove the 3 hinge screws into the face of the steamer of the Top Hinge.
5. Pull the door handle and remove the Door.
6. **Re-install in reverse order. Ensure Anti-sieze is re-applied to all hinge screws.**

**Fig O**



**Fig P**



Face Screws

**If the Door Handle Latch Is Moved to the Opposite Side, Ensure That the Door Switch Is Moved to the Corresponding Door Handle Latch Side .**

**STEAMER WILL NOT OPERATE IF NOT DONE.**

## INNER-DOOR PANEL

1. Unplug the unit and shut the Door.
2. Remove the Hinge Covers. **Fig O**
3. Remove the very bottom screw on the door hinge-side of the Bottom Hinge.
4. Remove the very top screw on the door hinge-side of the Top Hinge.
5. Pull the door handle and open the door
6. Lift and pull out the Inner Door Panel.
7. **Re-install in reverse order. Ensure Anti-sieze is re-applied to all hinge screws.**

Inner Door



**Fig R**



**Fig S**



**Ensure That the Inner Door is Reinstalled with its Middle Brace Bar Behind the Door Latch Tab. Fig R**  
**Also, Ensure That the Screw Retainer Openings are Lined-Up with the Door's Hinge Side. Fig S**

# DOOR COMPONENTS REMOVAL & INSTALLATION

## DOOR HANDLE LATCH ASSEMBLY

1. Unplug the unit & shut the Door.
2. Remove the Hinge Covers. ***Fig O***
3. Remove the very bottom screw on the door hinge-side of the Bottom Hinge & remove the very top screw on the door-side hinge of the Top Hinge.
4. Pull the door handle and open the door
5. Lift and pull out the Inner Door Panel.
6. Remove the 3 mounting nuts and screws, holding the Door Handle Latch to the side of the door, and the Inner Door Holding Tab.
7. Remove the Door Handle Latch Assembly.
8. **Re-install in reverse order. Ensure Anti-sieze is re-applied to all hinge screws.**



## DOOR HINGE

1. Unplug the unit & shut the Door.
2. Remove the Hinge Covers. ***Fig O***
3. Remove the 3 hinge screws going into the face of the steamer of the Bottom Hinge.
4. While supporting the Door on the hinge-side, remove the 3 hinge screws into the face of the steamer of the Top Hinge.
5. Pull the door handle and remove the Door.
6. Remove the very bottom screw on the door hinge-side of the Bottom Hinge & remove the very top screw on the door-side hinge of the Top Hinge.
7. Lift and pull out the Inner Door Panel.
8. Remove the remaining door-side screws for the hinge or hinges to be replaced. (*Note the orientation of the Hinge Spacer Bars as they relate to the Hinge orientation.*)
9. Remove the Door Hinge or Hinges.
10. **Re-install in reverse order. Ensure Anti-sieze is re-applied to all hinge screws.**

**Ensure That the Inner Door is Reinstalled with its Middle Brace Bar Behind the Door Latch Tab. ***Fig R*****  
**Also, Ensure That the Screw Retainer Openings are Lined-Up with the Door's Hinge Side. ***Fig S*****



# DOOR COMPONENTS REMOVAL & INSTALLATION

## DOOR GASKET

1. Unplug the unit & shut the Door.
2. Remove the Hinge Covers. ***Fig O***
3. Remove the very bottom screw on the door hinge-side of the Bottom Hinge & remove the very top screw on the door-side hinge of the Top Hinge.
4. Pull the door handle and open the door
5. Lift and pull out the Inner Door Panel.
6. Remove the 6, Gasket retaining brackets by removing the 12 nyloc mounting nuts holding them in place.
7. Remove the Door Gasket.
8. **Re-install in reverse order. Ensure Anti-sieze is re-applied to all hinge screws.**

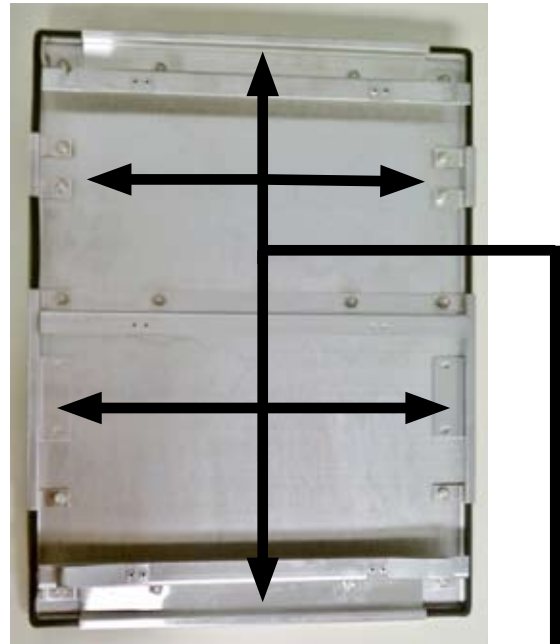

**Gasket Retaining  
Brackets**

### **INSTALLATION NOTE:**

- **Make sure the new Door Gasket is untangled.**
- **Starting at one corner, stretch the Gasket to the opposite corner.**
- **Repeat this sequence until all 4 corners are seated.**
- **Push the Gasket down all the way around to ensure the Gasket seats firmly on the inner door.**

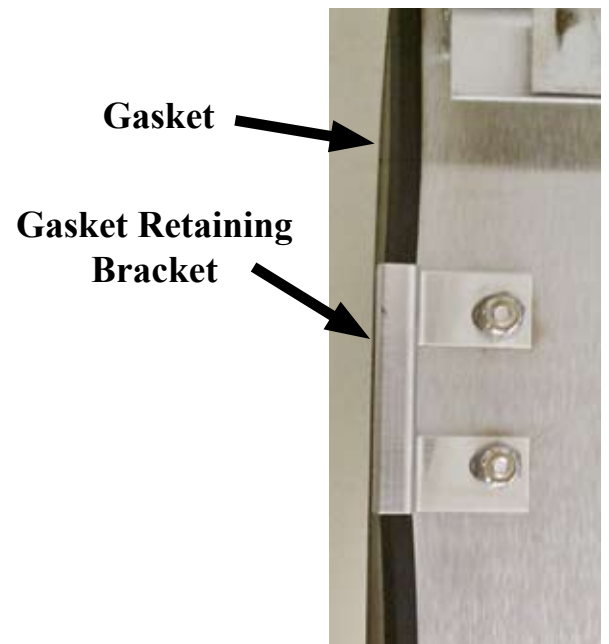

**Ensure That the Inner Door is Reinstalled with its Middle Brace Bar Behind the Door Latch Tab. *Fig R***  
**Also, Ensure That the Screw Retainer Openings are Lined-Up with the Door's Hinge Side. *Fig S***



# GAS EVOLUTION WIRING SCHEMATIC (S/N: 36980 & BELOW)

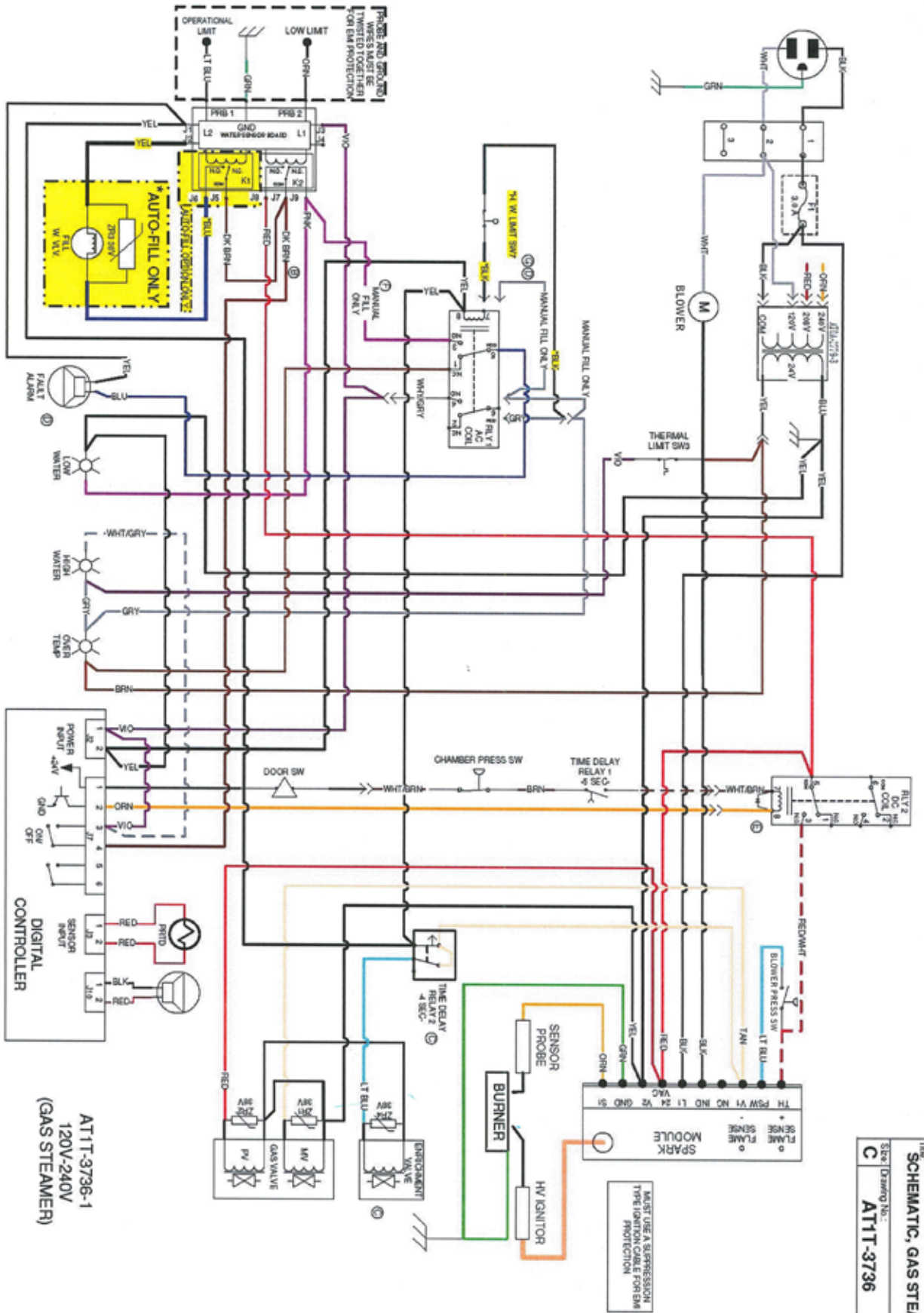

# GAS EVOLUTION WIRING SCHEMATIC (S/N: 36981 & ABOVE)

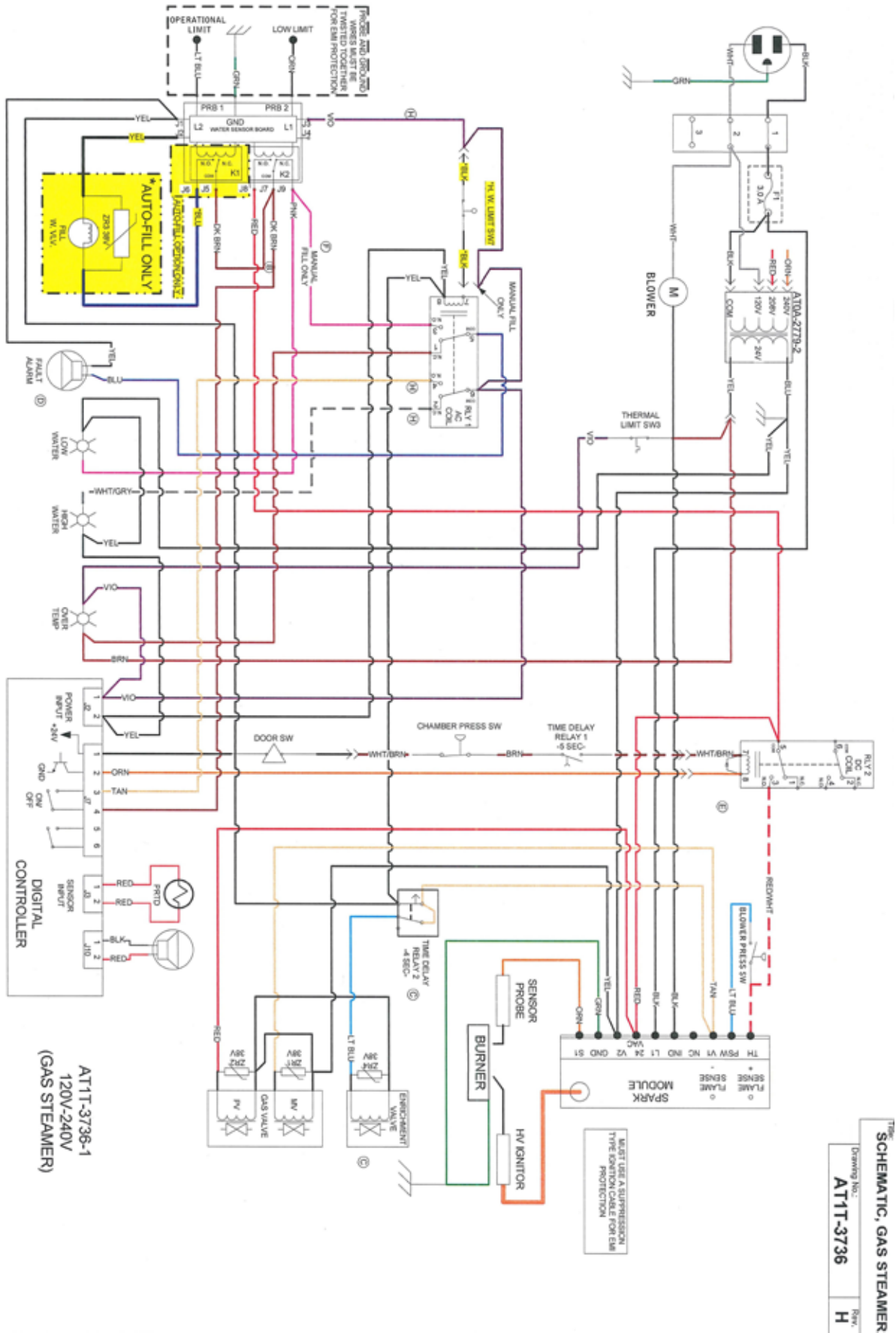

THE  
SCHEMATIC, GAS STEAMER  
Drawing No. **ATT1-3736** Rev. **H**

# GAS ORIFICE SIZE TO ALTITUDE CHART

Heating Valve Natural Gas: 900 BTU's/hr			Propane: 2200 BTU's/hr	
Altitude ft	Enrichment Orifice	Main Burner	Enrichment Orifice	Main Burner
3000	60	29	68	3/32
4000	60	29	71	3/32
5000	62	30	72	42
6000	62	30	72	43
7000	63	0.125	73	43
8000	64	31	73	44
9000	65	31	73	44
10000	66	31	74	45
11000	67	32	74	46
12000	68	33	75	46
13000	68	34	76	49
14000	69	7/64	76	49

Heating Valve Natural Gas: 1000 BTU's/hr			Propane: 2300 BTU's/hr	
Altitude ft	Enrichment Orifice	Main Burner	Enrichment Orifice	Main Burner
3000	60	29	68	3/32
4000	60	29	71	3/32
5000	62	30	72	42
6000	62	30	72	43
7000	63	0.125	73	43
8000	64	31	73	44
9000	65	31	73	44
10000	66	31	74	45
11000	67	32	74	46
12000	68	33	75	46
13000	68	34	76	49
14000	69	7/64	76	49

Heating Valve Natural Gas: 1100 BTU's/hr			Propane: 2500 BTU's/hr	
Altitude ft	Enrichment Orifice	Main Burner	Enrichment Orifice	Main Burner
3000	60	30	68	3/32
4000	60	30	71	3/32
5000	62	0.125	72	42
6000	62	31	72	43
7000	63	31	73	43
8000	64	32	73	44
9000	65	32	73	44
10000	66	34	74	45
11000	67	35	74	46
12000	68	35	75	46
13000	68	35	76	49
14000	69	37	76	49

# IGNITOR/FLAME SENSE PROBE SPACING MEASUREMENT

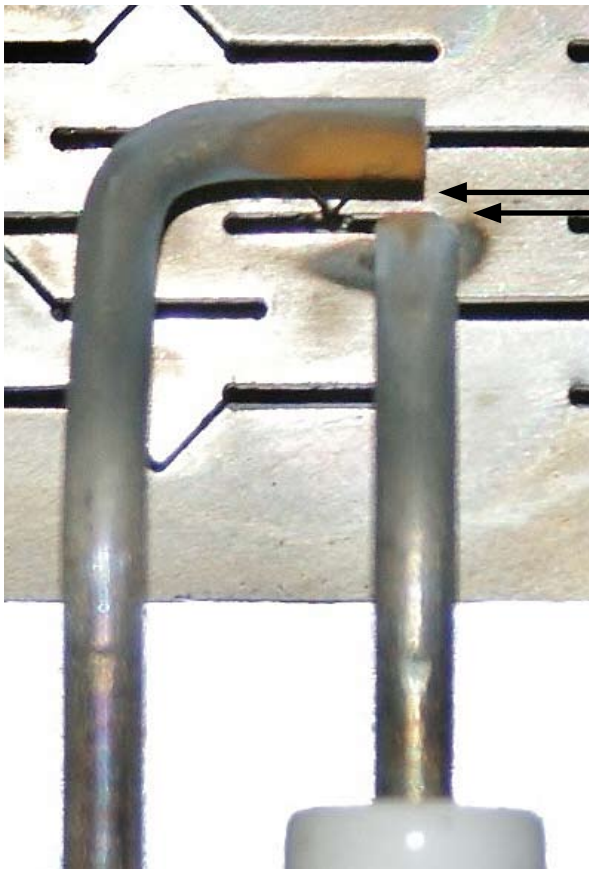

.095"

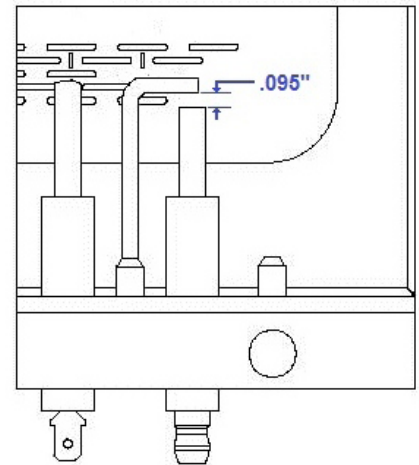

The distance between the GND Probe and the Ignitor Probe is .095". (This distance is roughly the thickness size of a nickel.)

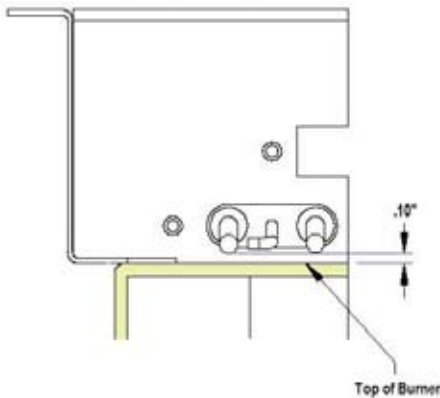

The distance between the Flame Sense Probe/Ignitor Probe and the Burner's surface is .10". (This distance is roughly the thickness size of a nickel.)

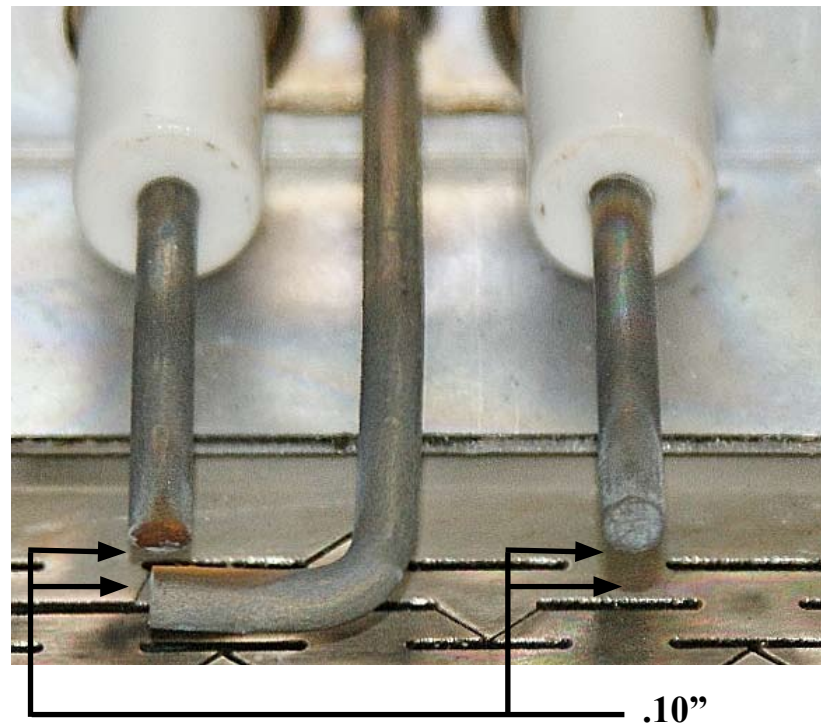

.10"