

Owner's Manual

VALUE LINE | LOW VOLUME
COMMERCIAL MICROWAVE OVEN

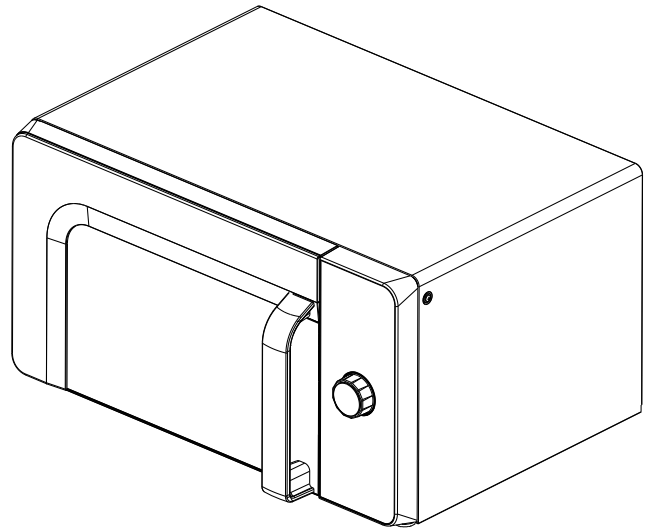
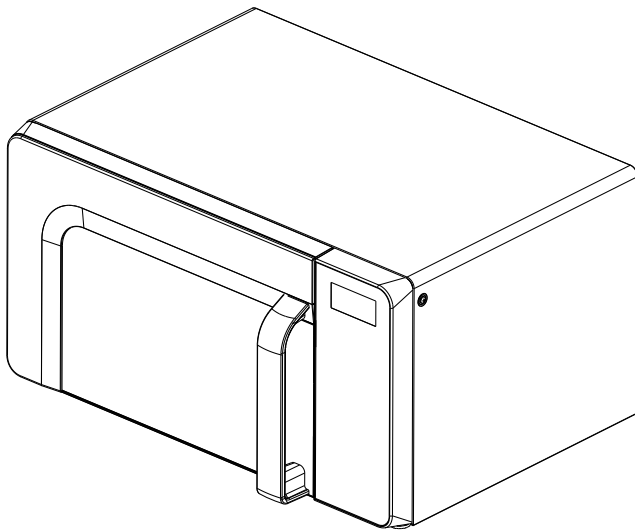

Keep these instructions for future reference. If the equipment changes ownership, be sure this manual accompanies equipment. Please refer to the **SAFETY INSTRUCTIONS** for important safety information prior to using this oven

Table of Contents	
Model Identification.....	2
Important Safety Instructions.....	3-4
Installation.....	5
Electronic Control Operation	6-8
Dial Operation.....	9
Care and Cleaning.....	10
Before Calling for Service.....	11

Model Identification

When contacting ACP, provide product information. Product information is located on oven serial plate. Record the following information:

Model Number: _____
Manufacturing Number: _____
Serial or S/N Number: _____
Date of purchase: _____
Dealer's name and address: _____

Keep a copy of sales receipt for future reference or in case warranty service is required.

Any questions or to locate an authorized ACP servicer, call ACP ComServ Service Support.

- **Inside** the U.S.A. or Canada, call toll-free at 1-866-426-2621.
- **Outside** the U.S.A. and Canada, call 1-319-368-8195.
- **Email:** commercialservice@acpsolutions.com

Warranty service must be performed by an authorized ACP servicer. ACP also recommends contacting an authorized ACP servicer, or ACP ComServ Service Support if service is required after warranty expires.

Before using your oven, please take the time to read the Safety Instructions which shipped with the oven.

Information herein is subject to change without notice. Errors are subject to correction.
For the most recent product literature, please visit acpsolutions.com/product-literature/



IMPORTANT SAFETY INSTRUCTIONS

RECOGNIZE THIS SYMBOL AS A SAFETY MESSAGE

WARNING

When using electrical equipment, basic safety precautions should be followed to reduce the risk of burns, electrical shock, fire, or injury to persons including the following.

1. READ all instructions before using equipment.
2. READ AND FOLLOW the specific "PRECAUTIONS TO AVOID POSSIBLE EXPOSURE TO EXCESSIVE MICROWAVE ENERGY" on this page.
3. This equipment **MUST BE GROUNDED**. Connect only to properly GROUNDED outlet. See "GROUNDING / EARTHING INSTRUCTIONS".
4. Install or locate this equipment **ONLY** in accordance with the installation instructions in this manual.
5. Liquids or other foods, must **NOT** be HEATED in sealed containers since they are liable to explode.
6. To avoid scalding, do **NOT** use loaded containers with liquids or cooking goods which becomes fluid by heating in higher levels than those which can be easily observed.
7. Eggs in their shell and whole hard-boiled eggs should **NOT** be HEATED in microwave ovens since they may explode even after microwave heating has ended.
8. Use this equipment **ONLY** for its intended use as described in this manual. Do not use corrosive chemicals or vapors in this equipment. This type of oven is specifically designed to heat, cook, or dry food. It is not designed for industrial or laboratory use.
9. This appliance is **NOT** intended for use by persons (including children) with reduced physical, sensory or mental capabilities, or lack of experience and knowledge, unless they have been given supervision or instruction concerning use of the appliance by a person responsible for their safety
10. **CHILDREN SHOULD BE SUPERVISED** to ensure that they **DO NOT** play with the appliance.
11. **DO NOT** heat baby bottles in oven. Baby food jars shall be open when heated and contents stirred or shaken and the temperature checked before consumption, in order to avoid burns.
12. **DO NOT** operate this equipment if it has a damaged cord or plug, if it is not working properly, or if it has been damaged or dropped.
13. If door or door seals are damaged, the oven must **NOT** be operated until it has been repaired by a qualified service person.
14. It is hazardous for anyone other than a qualified service person to carry out any service or repair operation that involves the removal of any cover which gives protection against exposure to microwave energy.
15. This equipment, including power cord, must be serviced **ONLY** by qualified service personnel. Special tools are required to service equipment. Contact nearest authorized service facility for examination, repair, or adjustment.
16. **DO NOT** cover or block louvers or other openings on equipment.
17. See door, cavity cleaning instructions in "Care and Cleaning" section of product safety manual.
18. **DO NOT** store this equipment outdoors. **DO NOT** use this product near water – for example, near a kitchen sink, in a wet basement, a swimming pool, or a similar location.
19. **DO NOT** immerse cord or plug in water.
20. Keep cord **AWAY** from HEATED surfaces.
21. **DO NOT** let cord hang over edge of table or counter.
22. For commercial use only.

PRECAUTIONS TO AVOID POSSIBLE EXPOSURE TO EXCESSIVE MICROWAVE ENERGY

- A. **DO NOT** attempt to operate this oven with the door open since open door operation can result in harmful exposure to microwave energy. It is important not to defeat or tamper with the safety interlocks.
- B. **DO NOT** place any object between the oven front face and the door too allow soil or cleaner residue to accumulate on sealing surfaces.
- C. **DO NOT** operate the oven if it is damaged. It is particularly important that the oven door close properly and that there is no damage to the:
 1. door (bent)
 2. hinges and latches (broken or loosened)
 3. door seals and sealing surfaces.
- D. The oven should not be adjusted or repaired by anyone except properly qualified service personnel.

SAVE THESE INSTRUCTIONS

IMPORTANT SAFETY INSTRUCTIONS

RECOGNIZE THIS SYMBOL AS A SAFETY MESSAGE

WARNING

To avoid risk of fire in the oven cavity:

- a. DO NOT overcook food.
- b. When heating food in plastic, paper, or other combustible containers, keep an eye on oven due to the possibility of ignition.
- c. Remove wire twist-ties from paper or plastic bags before placing bag in oven.
- d. If materials inside the oven ignite, keep oven door CLOSED, turn oven off and disconnect the power cord, or shut off power at the fuse or circuit breaker panel.
- e. DO NOT use the cavity for storage. DO NOT leave paper products, cooking utensils, or food in the cavity when not in use.

WARNING

Liquids such as water, coffee, or tea are able to be overheated beyond the boiling point without appearing to be boiling due to surface tension of the liquid. Visible bubbling or boiling when the container is removed from the microwave oven is not always present. THIS COULD RESULT IN VERY HOT LIQUIDS SUDDENLY BOILING OVER WHEN A SPOON OR OTHER UTENSIL IS INSERTED INTO THE LIQUID. To reduce the risk of injury to persons:

- i. Do not overheat the liquid.
- ii. Stir the liquid both before and halfway through heating it.
- iii. Do not use straight-sided containers with narrow necks.
- iv. After heating, allow the container to stand in the microwave oven for a short time before removing the container.
- v. Use extreme care when inserting a spoon or other utensil into the container.

CAUTION

To avoid personal injury or property damage, observe the following:

1. Do not deep fat fry in oven. Fat could overheat and be hazardous to handle.
2. Do not cook or reheat eggs in shell or with an unbroken yolk using microwave energy. Pressure may build up and erupt. Pierce yolk with fork or knife before cooking.
3. Pierce skin of potatoes, tomatoes, and similar foods before cooking with microwave energy. When skin is pierced, steam escapes evenly.
4. Do not operate equipment without load or food in oven cavity.
5. Use only popcorn in packages designed and labeled for microwave use. **Popping time varies depending on oven wattage.** Do not continue to heat after popping has stopped. Popcorn will scorch or burn. Do not leave oven unattended.
6. Do not use regular cooking thermometers in oven. Most cooking thermometers contain mercury and may cause an electrical arc, malfunction, or damage to oven.
7. Do not use metal utensils in oven.
8. Do not use aluminum foil in oven. Never use paper, plastic, or other combustible materials that are not intended for cooking.
9. Only use utensils that are suitable for use in microwave ovens.
10. When cooking with paper, plastic, or other combustible materials, follow manufacturer's recommendations on product use.
11. Do not use paper towels which contain nylon or other synthetic fibers. Heated synthetics could melt and cause paper to ignite.
12. Do not heat sealed containers or plastic bags in oven. Food or liquid could expand quickly and cause container or bag to break. Pierce or open container or bag before heating.
13. To avoid pacemaker malfunction, consult physician or pacemaker manufacturer about effects of microwave energy on pacemaker.
14. An authorized servicer **MUST** inspect equipment annually. Record all inspections and repairs for future use.
15. Clean oven regularly and remove any food deposits.
16. Failure to maintain the oven in a clean condition could lead to deterioration of the surface that could adversely affect the life of the appliance and possibly result in a hazardous situation.
17. Do NOT use water pressure type cleaning systems.

SAVE THESE INSTRUCTIONS

Installation

Grounding/Earthing Instructions

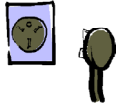

Oven MUST be grounded. Grounding reduces risk of electric shock by providing an escape wire for the electric current if an electrical short occurs. This oven is equipped with a cord having a grounding wire with a grounding plug. The plug must be plugged into an outlet that is properly installed and grounded.

⚠ WARNING

To avoid risk of electrical shock or death, this oven must be grounded and plug must not be altered.

Consult a qualified electrician or servicer if grounding instructions are not completely understood, or if doubt exists as to whether the oven is properly grounded.

Do not use an extension cord.

If the product power cord is too short, have a qualified electrician install a three-slot receptacle. This oven should be plugged into a separate circuit with the electrical rating as provided in product specifications (available at www.acpsolutions.com). When a microwave oven is on a circuit with other equipment, an increase in cooking times may be required and fuses can be blown.

EXTERNAL EQUIPOTENTIAL EARTHING TERMINAL (EXPORT ONLY)

Equipment has secondary earthing terminal. Terminal provides external earthing connection used in addition to earthing prong on plug. Located on outside of oven back, terminal is marked with symbol shown at right



Unpacking Oven

- Inspect oven for damage such as dents in door or inside oven cavity.
- Report any dents or breakage to source of purchase immediately.
Do not attempt to use oven if damaged.
- Remove all packing materials from oven interior.
- If oven has been stored in extremely cold area, wait a few hours before connecting power.

Radio Interference

Microwave operation may cause interference to radio, television. Reduce or eliminate interference by doing the following:

- Clean door and sealing surfaces of oven according to instructions in “Care and Cleaning” section.
- Place radio, television, etc. as far as possible from oven.
- Use a properly installed antenna on radio, television, etc. to obtain stronger signal reception.

Oven Placement

- Do not install oven next to or above source of heat, such as pizza oven or deep fat fryer. This could cause oven to operate improperly and could shorten life of electrical parts.
- Do not block or obstruct oven filters. Allow access for cleaning.
- Install oven on level counter-top surface.
- Place warning label in a conspicuous place close to microwave oven.
- Outlet should be located so that plug is accessible when oven is in place.

OVEN CLEARANCES

- A. Allow at least 7” (17.78 cm) of clearance around top of oven. Proper air flow around oven cools electrical components. With restricted air flow, oven may not operate properly and life of electrical parts is reduced.
- B. There is not an installation clearance requirement for the back of the oven.
- C. Allow at least 1” (2.54 cm) of clearance around sides of oven.
- D. Install oven so oven bottom is at least 3 feet (91.5 cm) above floor.

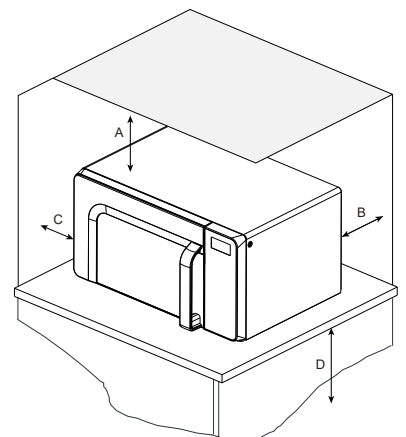
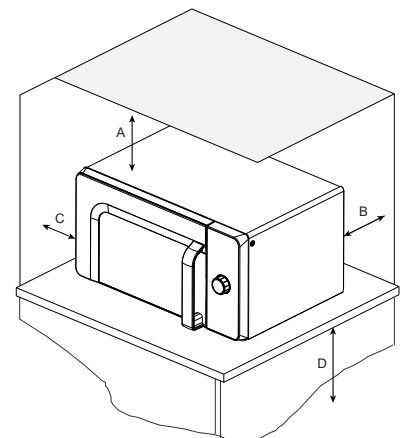

Electronic Control Operation

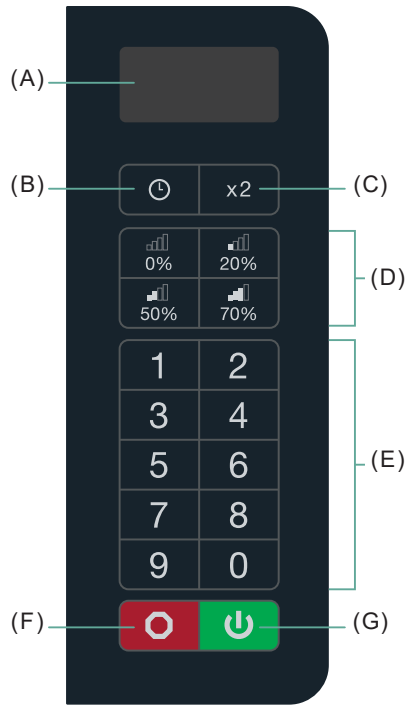

Note: Control panel coloring may vary by model

Control Panel Features

- (A) **LED DISPLAY**
- (B) **TIME ENTRY KEY**
- (C) **X2 KEY**
- (D) **POWER LEVEL KEYS**
- (E) **NUMBER KEYS / PRESET PROGRAM KEYS**
- (F) **STOP/RESET KEY**
- (G) **START KEY**

So...how do I use it?

Interrupting Operation (Pause Mode)

While the oven is operating, press STOP/RESET key to interrupt operation. Display shows remaining cooking time. Close door and press START key to resume oven operation.

Canceling Mistakes

If oven is not cooking, press STOP/RESET key to clear display. If oven is cooking, press STOP/RESET key once to stop oven, then again to clear display. If oven door is open and time shows in display, close oven door and press STOP/RESET key to clear display.

Manual Time Entry Mode

Time entry mode allows the user to manually enter a cook time and power level.

1. Open oven door and place food in oven. Close door.
2. Press the TIME ENTRY key . "00:00" is displayed.
3. Press Number Keys to enter the desired cook time.
4. Press POWER LEVEL key , , or to select power level. LED will display the related power. If the same key is pressed twice, the power will change to PL10 (Power Level 10 or full power). If no power chosen, PL10 is default.
5. Press START key to begin cooking. Oven begins cooking and the LED displays cooking time.
6. At the end of the cooking cycle, the oven beeps and LED displays "End".

Operating Preset Program Keys

From the factory, this oven can store up to 10 preprogrammed cooking sequences in memory, for one key touch operation.

1. Open oven door and place food in oven. Close door.
2. Press a Number Key to run the Preset Program associated with that key. Oven begins cooking and the LED displays cooking time.
3. At the end of the cooking cycle, the oven beeps and LED displays "End".

FACTORY PRESET PROGRAM SETTINGS

NUMBER KEY	TIME	POWER
1	10 sec.	100%
2	20 sec.	
3	30 sec.	
4	45 sec.	
5	1:00 min.	
6	1:30 min.	
7	2:00 min.	
8	3:00 min.	
9	4:00 min.	
0	5:00 min.	

*Note: Factory setting may vary by model

The switching operation of this microwave oven can cause voltage fluctuations on the supply line. The operation of this oven under unfavorable voltage supply conditions can have adverse effects. This device is intended for the connection to a power supply system with a maximum permissible system impedance Z_{max} of 0.2 Ohms at the interface point of the user's supply. The user has to ensure that this device is connected only to a power supply system which fulfills the requirement above. If necessary, the user can ask the public power supply company for the system impedance at the interface point.





Electronic Control Operation

Programming Mode

This mode allows the user to assign cook times, power levels, and stage cooking to the Number Keys.

1. Open oven door and press and hold Number Key “1” for 5 seconds. The oven beeps and LED displays “ProG”.

Note: If STOP/RESET key  is pressed before programming is complete, changes are discarded and microwave exits programming mode.



2. Press a Number Key to change or review a Preset Program setting.
3. Press Number Keys to enter the new desired cook time.
4. Press POWER LEVEL key , , , or  to select power level. LED will display the related power. If the same key is pressed twice, the power will change to PL10 (Power Level 10 or full power). If no power chosen, PL10 is default.
5. Press START key  to save the cooking program. LED displays “ProG”.

Note: If the program chosen exceeds the maximum time allowed by User Option 7, then the oven will beep three times and return to “ProG” to indicate the program is unacceptable.

6. Close the door to exit Programming Mode.

Programming Multiple Cooking Stages

This allows food items to be cooked using a combination of various power levels and times. A maximum of four stages can be set.

1. From Programming Mode or Manual Time Entry Mode, set time and power level for the first stage.
2. Press TIME ENTRY key  to set the next stage. LED displays “S-2”, “S-3” or “S-4” to indicate second, third, or fourth stage. Set time and power for the stage.
3. Repeat step 2 for any subsequent stages.
4. Press START key  to save the cooking program or begin cooking.

X2 - Double Quantity Cooking

The X2 pad allows two quantities of the same food item to be cooked at once



Note: X2 function may be used only with Preset Program Number Keys.

1. Open oven door and place food in oven. Close door.
2. Press X2 key , LED displays “doub”.
3. Press desired Preset Program Number Key(s). LED displays the cooking time for two quantities. The oven will start cooking per the quantity preset cooking time.
4. At the end of the cooking cycle, the oven beeps and LED displays “End”.

Example: If number “5” key is programmed to cook for 1:00, when first pressing X2 key and then pressing number “5” key, the oven will automatically set the cook time to 1:48. (1:00 cook cycle x 80% “X2” cook factor = 1:48)

PROGRAMMING EXAMPLE:





To save a cook setting of 1 minute and 25 seconds at 70% power on Number Key “3”.

1. Open oven door and press Number Key “1” for 5 seconds. LED displays “ProG”.
2. Press Number Key “3”.
3. Press Number Keys “1”, “2” and “5” to input the cooking time. LED displays 1:25.
4. Press 70% POWER LEVEL key  to input 70% power level. LED displays “PL7”.
5. Press START key  to save.
6. To use this program press “3”. The oven will start operating for 1:25 at 70% power.

MULTIPLE STAGE

PROGRAMMING EXAMPLE:

To save a cook setting of two stages on Number Key “3”. Stage 1: 1 minute 25 seconds at 70% power; Stage 2: 5 minutes 40 seconds at 50% power.

1. Open oven door and press Number Key “1” for 5 seconds. LED displays “ProG”.
2. Press Number Key “3”.
3. Press Number Keys “1”, “2” and “5” to input the cooking time. LED displays 1:25.
4. Press 70% POWER LEVEL key  to input 70% power level. LED displays “PL7”. The first stage is finished.
5. Press TIME ENTRY key , LED displays “S-2”.
6. Press Number Keys “5”, “4”, “0” button, LED displays “5:40”
7. Press 50% POWER LEVEL key  to input 50% power. LED displays “PL5”. The second stage is finished.
8. Press START key  to save.
9. To use this program press “3”. The oven will start operating for 7:05 (1:25 at 70% power + 5:40 at 50% power).

Electronic Control Operation

On-the-Fly Cooking



On-the-Fly Cooking allows the user to start another cook cycle while the oven is operating or paused.

Note: User Option OP:51 must be enabled for use of On-the-Fly cooking.

1. While the oven is cooking or while in Pause Mode, press a Number Key to automatically start the Preset Program associated with that key.
2. Oven begins cooking and the LED displays cooking time.
3. At the end of the cooking cycle, the oven beeps and LED displays "End".

User Option Mode

This allows the user to customize various oven settings.

1. Open oven door and press Number Key "2" for 5 seconds. Oven beeps and LED displays "OP: - -".
2. Press any Number Key to enter related options as noted in chart below.
3. To change, repeat pressing the Number Key until desired setting is reached.
4. Press START key  to save the selected setting. LED displays "OP: - -" to indicate selection was saved and another option change can be made.
5. To exit User Option Mode, press STOP/RESET key  and close door.

Note: If START key  is not pressed as the last step, the selected option will not be saved.

CHANGING USER OPTION

EXAMPLE:

To set the key beep volume to high.

1. Open oven door and press Number Key "2" for 5 seconds. LED displays "OP: - -".
2. Press Number Key "2". "OP:22" displays.
3. To change, repeat pressing "2". LED displays "OP:20", "OP:21", "OP:22", "OP:23" etc. Stop pressing once "OP:23" displays.
4. Press START key  to save the selected setting. LED displays "OP: - -" to indicate selection was saved and another option change can be made.

NUMBER KEY	DISPLAY	OPTIONS (FACTORY SETTINGS IN BOLD)
1 End of Cycle Beep	OP:10 OP:11 OP:12	3 second beep Continuous beep until door is opened 5 beep bursts until door is opened
2 Key Beep Volume	OP:20 OP:21 OP:22 OP:23	Eliminates beep Sets volume to low Sets volume to medium Sets volume to high
3 Key Beep	OP:30 OP:31	Prevents beep when pad is pressed Allows beep when pad is pressed
4 Active Display	OP:40 OP:41 OP:42 OP:43	15 seconds after oven door is opened, keyboard disabled 30 seconds after oven door is opened, keyboard disabled 1 minute after oven door is opened, keyboard disabled 2 minutes after oven door is opened, keyboard disabled
5 On-the-Fly Cooking	OP:50 OP:51	Prevents different pre-programmed pads to be activated during cooking Allows different pre-programmed pads to be activated during cooking
6 Reset Door Open	OP:60 OP:61	Allows oven to resume heating time countdown after door is opened during cycle Cancels heating time count down after door is opened during cycle.
7 Maximum Heating Time	OP:70 OP:71	Allows 30 minutes of heating time Allows 10 minutes of heating time
8 Manual Operation	OP:80 OP:81	Allows use of preprogrammed pads only Allows use of manual time entry and preprogrammed pads
9 Double Digit Operation	OP:90 OP:91	Allows 10 (0-9) preprogrammed pads Allows 20 (00-99) preprogrammed pads

***Note:** Factory setting may vary by model

Dial Operation

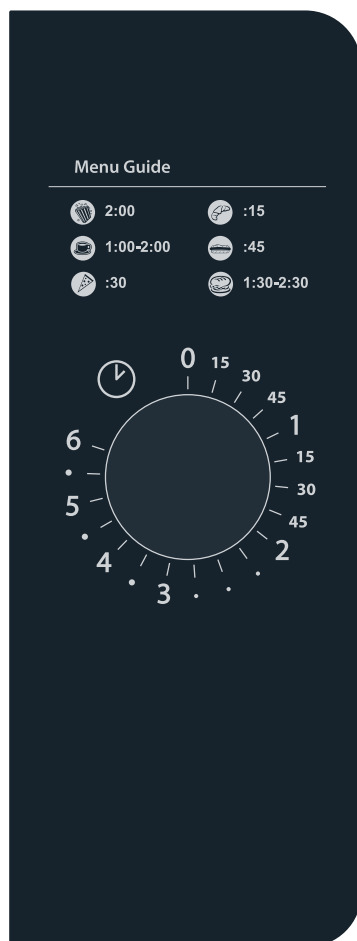

So...how do I use it?

Heating

1. Open oven door and place food in oven. Close door.
2. Turn time entry knob clockwise to desired time.
 - Cooking time can be set up to 6 minutes.
 - Oven begins operation and time counts down.
3. When cooking time has elapsed, microwave energy stops and oven signal sounds.

Interrupting and Stopping Operation

1. Open oven door to interrupt and stop operation or turn time entry knob counterclockwise to "0".
2. When cooking is interrupted by opening door, oven automatically resets to zero time.
3. To resume microwave oven operation, close door and re-enter desired time by turning knob clockwise.

Changing Time and Canceling Mistakes

Heating time can be changed at any time while the oven is operating. Turn knob to desired new setting.

To set cooking time to zero, turn knob counterclockwise to "0". Setting the time to zero cancels the set cooking time and turns the oven off.

Care and Cleaning

Microwave energy is attracted to any food source in the oven. Food splatters or spills can affect heating performance, and can also cause oven damage. To prevent damage to oven, keep the microwave oven clean and remove any food debris. Follow the recommendations below for proper maintenance of oven.

WARNING: NOT FOLLOWING APPROVED OVEN CLEANING INSTRUCTIONS MAY VOID YOUR OVEN WARRANTY

⚠ Do NOT use abrasive cleaners or cleaners containing ammonia, citrus, phosphates, chlorine, sodium or potassium hydroxide (lye). The use of caustic cleaning products or those containing ammonia, citrus, phosphates, chlorine, sodium or potassium hydroxide (lye) can damage critical oven parts.

Use of unapproved cleaning agents will void the terms of the warranty.

⚠ Never pour water into microwave oven bottom.

⚠ Do NOT use water pressure type cleaning systems.

⚠ Never turn on or operate oven during cleaning procedure. Always unplug oven before cleaning.

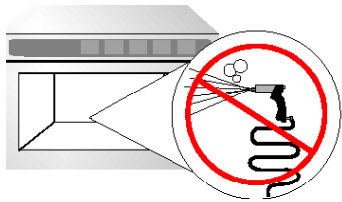

DO NOT power spray

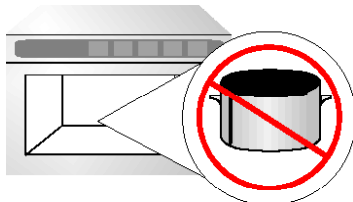

No metal pans

⚠ WARNING

To avoid electrical shock which can cause severe personal injury or death, unplug power cord or open circuit breaker to oven before cleaning.

Wear protective gloves and protective glasses when cleaning the oven.

Failure to maintain the oven in a clean condition could lead to deterioration of the surface that could adversely affect the life of the appliance and possibly result in a hazardous situation.

Daily Care and Cleaning

INTERIOR, EXTERIOR, AND DOOR

1. Unplug Oven 
2. Remove any food debris
3. Clean microwave oven with mild detergent in warm water using soft sponge or cloth. Wring sponge or cloth to remove excess water before wiping equipment.
4. If desired, boil a cup of water in microwave oven to loosen soil before cleaning.

CONTROL PANEL

1. Open oven door to deactivate oven timer.
2. Clean with mild detergent in warm water using soft sponge or cloth.

Monthly Care and Cleaning

DISCHARGE AIR VENTS

Check monthly for a buildup of cooking vapors along intake and discharge louvers on bottom and back of oven. Clean air vents with damp cloth to ensure proper airflow. Dry thoroughly.

Before Calling for Service

Record all inspections and repair for future reference.

WARNING

To avoid electrical shock which can cause severe personal injury or death, do not remove outer case at any time. Only an authorized servicer should remove outer case.

SYMPTOM	POSSIBLE CAUSE	REMEDY
Dim oven light	Cooking at low power level.	This is normal
Steam forms on oven door	Cooking food in a microwave generates steam.	This is normal
Hot air expelled from vents	Cooking food in a microwave releases heat.	This is normal
Oven does not start	Power cord not plugged in correctly.	Plug cord into outlet correctly.
	Fuse blown or circuit breaker open.	Replace fuse (should be repaired by authorized servicer) or reset breaker.
	Malfunctioning outlet	Test outlet with other electrical appliances.
	Door not closed.	Close door.
Oven fan runs after oven is done cooking	Fan cools oven components	It is normal for fan to run 60 seconds

Amana® Commercial Models
Contact:



866-426-2621

MenuMaster® Models
Contact:



866-811-8559

email: commercialservice@acpsolutions.com

For full product documentation visit:

www.acpsolutions.com