



REFRIGERATORS REFRIGERATOR-FREEZERS FREEZERS

MODELS:

Refrigerators: ALR46W, ALR47B, BIAR402, BIAR405B
Refrigerator-Freezers: ALRF48, ALR49B, BIRF403, BIRF406B
Freezers: ALFZ36, ALFZ37B, BIFZ404, BIFZ407B

User Manual

BEFORE USE, PLEASE READ AND FOLLOW ALL SAFETY RULES AND OPERATING INSTRUCTIONS.

Write Serial Number (on lower left corner of inside cabinet) here:

Serial No.: _____

Felix Storch, Inc.
An ISO 9001:2015 registered company
770 Garrison Avenue
Bronx, NY 10474
www.summitappliance.com

TABLE OF CONTENTS

Appliance Safety	3
Important Safeguards	3-4
Installation Instructions	5-7
<i>Before Using your Appliance</i>	5
<i>Installation of your Appliance</i>	5
<i>Electrical Connection</i>	5-6
<i>Extension Cord</i>	6
<i>Reversing the Door Swing</i>	6
<i>Installing the Handle</i>	7
Operating your Appliance	7-10
<i>Control Panel (Refrigerator and Freezer Models)</i>	7-8
<i>Alarms</i>	9
<i>Defrosting</i>	10
<i>Shelves</i>	10
Care and Maintenance	11
<i>Cleaning your Appliance</i>	11
<i>Power Failure</i>	11
<i>Vacations</i>	11
<i>Moving your Appliance</i>	11
<i>Energy-Saving Tips</i>	11
Troubleshooting	12
Parameter Table	13-15
Limited Warranty	16

APPLIANCE SAFETY

Your safety and the safety of others are very important.

We have provided many important safety messages in this manual and on your appliance. Always read and obey all safety messages.



This is the Safety Alert Symbol. The symbol alerts you to potential hazards that can kill or injure you and others. All safety messages will follow the Safety Alert Symbol and either the word DANGER or WARNING.



DANGER means that failure to heed this safety statement may result in severe personal injury or death.



WARNING means that failure to heed this safety statement may result in extensive product damage, serious personal injury, or death.

All safety messages will alert you about the potential hazard, tell you how to reduce the chance of injury, and let you know what can happen if the instructions are not followed.

IMPORTANT SAFEGUARDS



Before the appliance is used, it must be properly positioned and installed as described in this manual, so read the manual carefully. To reduce the risk of fire, electrical shock or injury when using the appliance, follow basic precautions, including the following:



- Plug into a grounded 3-prong outlet, do not remove grounding prong, do not use an adapter, and do not use an extension cord.
- Replace all panels before operating.
- It is recommended that a separate circuit serving only your appliance be provided. Use receptacles that cannot be turned off by a switch or pull chain.
- Never clean appliance parts with flammable fluids. These fumes can create a fire hazard or explosion. And do not store or use gasoline or other flammable vapors and liquids in the vicinity of this or any other appliance. The fumes can create a fire hazard or explosion.
- Do not connect or disconnect the electric plug when your hands are wet.
- Unplug the appliance or disconnect power before cleaning or servicing. Failure to do so can result in electrical shock or death.
- Do not attempt to repair or replace any part of your appliance unless it is specifically recommended in this manual. All other servicing should be referred to a qualified technician.
- This appliance is CFC- and HFC-free and contains small quantities of Isobutane (R600a) which is environmentally friendly, but flammable. It does not damage the ozone layer, nor does it increase the greenhouse effect. Care must be taken during transportation and setting up of the appliance that no parts of the cooling system are damaged. Leaking coolant can ignite and may damage the eyes.

- In the event of any damage:
 - Avoid open flames and anything that creates a spark,
 - Disconnect from the power supply
 - Air the room in which the appliance is located for several minutes and
 - Contact the Service Department for advice.
- The more coolant there is in an appliance, the larger the room it should be installed in. In the event of a leakage, if the appliance is in a small room, there is the danger of combustible gases building up. For every ounce of coolant, at least 325 cubic feet of room space is required. The amount of coolant in the appliance is stated on the data plate inside the appliance. It is hazardous for anyone other than an Authorized Service Person to carry out servicing or repairs to this appliance.
- Take serious care when handling, moving and using the appliance to avoid either damaging the refrigerant tubing or increasing the risk of a leak.
- Replacing component parts and servicing shall be done by factory authorized service personnel, so as to minimize the risk of possible ignition due to incorrect parts or improper service.

WARNING

FOLLOW WARNING CALLOUTS BELOW ONLY WHEN APPLICABLE TO YOUR MODEL

- Use two or more people to move and install appliance. Failure to do so can result in back or other injury.
- To ensure proper ventilation for your appliance, the front of the unit must be completely unobstructed. Choose a well-ventilated area with temperatures above 44°F (7°C) and below 90°F (32°C).
- The appliance should not be located next to ovens, grills or other sources of high heat.
- The appliance must be installed with all electrical, water and drain connections in accordance with state and local codes. A standard electrical supply (115 V AC only, 60 Hz), properly grounded in accordance with the National Electrical Code and local codes and ordinances, is required.
- Do not kink or pinch the power supply cord of the appliance.
- The size of the fuse (or circuit breaker) should be 15 amperes.
- It is important that the appliance be leveled in order to work properly. You may need to make several adjustments to level it.
- All installations must be in accordance with local plumbing code requirements.
- Make certain that the pipes are not pinched, kinked or damaged during installation.
- Check for leaks after connection.
- Never allow children to operate, play with or crawl inside the appliance.
- Do not use solvent-based cleaning agents or abrasives on the interior. These cleaners may damage or discolor the interior.
- Use this appliance only for its intended purpose as described in this *Instruction Manual*.
- Keep fingers out of the “pinch point” areas. Clearances between the door and cabinet are necessarily small. Be careful closing the door when children are in the area.

DANGER

Risk of child entrapment!

Child entrapment and suffocation are not problems of the past. Junked or abandoned appliances are still dangerous, even if they will “just sit for a few days”.

Before discarding your old refrigerator:

- *Take off the doors*
- *Leave the shelves in place so that children may not easily climb inside.*

- SAVE THESE INSTRUCTIONS -

INSTALLATION INSTRUCTIONS

Before Using your Appliance

- Remove the exterior and interior packing.
- Before connecting the appliance to the power source, let it stand upright for approximately 2 hours. This will reduce the possibility of a malfunction in the cooling system from handling during transportation.
- Clean the interior surface with lukewarm water using a soft cloth.
- Install the handle on the door, if it is not already attached. (See page 8.)

Installation of your Appliance

- The appliance is designed for built-in or recessed or free standing installation for indoor use.

CAUTION: *This appliance is not designed for the storage of medicine or other medical products.*

- Place your appliance on a floor that is strong enough to support it when it is fully loaded. To level the unit, adjust the front leveling legs.
- For free standing installation, 5" (127mm) of space between the back and sides of the unit, and 4" (102mm) at the top, are suggested, which allows the proper air circulation to cool the compressor and condenser. Even for built-in installation, it is a must to keep ¼" (6.35mm) space on each side and at the top and 2" (51mm) at the rear. Take care that the air vent at the front of the appliance is never covered or blocked in any way.

NOTE: It is recommended that you do not install the appliance near an oven, radiator or other heating source. Direct sunlight may affect the acrylic coating and heat sources may increase electrical consumption. Don't install in a location where the temperature will fall below 44°F (7°C). For best performance, do not install the appliance behind a cabinet door or block the base grille.

- Avoid locating the unit in moist areas.
- Plug the appliance into an exclusive, properly grounded wall outlet.

Electrical Connection



WARNING

Improper use of the grounded plug can result in the risk of electrical shock. If the power cord is damaged, have it replaced by a qualified electrician or an authorized service center.

This appliance should be properly grounded for your safety. The power cord of this appliance is equipped with a three-prong plug which mates with standard three-prong wall outlets to minimize the possibility of electrical shock.

Do not under any circumstances cut or remove the third (ground) prong from the power cord supplied. For personal safety, this appliance must be properly grounded. Any questions concerning power and/or grounding should be directed toward a certified electrician or an authorized service center.

This appliance requires a standard 115/120 Volt AC ~60Hz three-prong grounded electrical outlet.

Have the wall outlet and circuit checked by a qualified electrician to make sure the outlet is properly grounded. When a standard 2-prong wall outlet is encountered, it is your responsibility and obligation to have it replaced with a properly grounded 3-prong wall outlet.

To prevent accidental injury, the cord should be secured behind the appliance and not left exposed or dangling.

The appliance should always be plugged into its own individual electrical outlet which has a voltage rating that matches the rating label on the appliance. This provides the best performance and also prevents overloading house wiring circuits that could cause a fire hazard from overheating. Never unplug the appliance by pulling on the power cord. Always grip the plug firmly and pull straight out from the receptacle. Repair or replace immediately all power cords that have become frayed or otherwise damaged. Do not use a cord that shows cracks or abrasion damage along its length or at either end. When moving the appliance, be careful not to damage the power cord.

Extension Cord

Because of potential safety hazards under certain conditions, it is strongly recommended that you do not use an extension cord with this appliance. However, if you must use an extension cord, it is absolutely necessary that it be a UL/CUL-Listed, 3-wire grounding type appliance extension cord having a grounding type plug and outlet and that the electrical rating of the cord be 115 volts and at least 10 amperes.

Reversing the Door Swing

NOTE: Some door styles are not user-reversible. Consult summitappliance.com for details.

If you find the direction of opening the door of the appliance inconvenient, you can change it. Holes on the opposite side have already been prepared at the factory. To reverse your door, follow these instructions:

1. Take the upper hinge cover from the door and remove the screws that hold the top hinge
2. Lift the hinge straight up to free the hinge pin from the socket in the top of the door
3. Lift the door up and away to free its bottom socket from the hinge pin
4. Remove the screws to the bottom hinge
5. Remove the decorative caps from the opposite side and plug the holes from the original side with the decorative caps
6. Move the bottom hinge to the opposite side and tighten the screws. Use any lock washers or nuts if they were used in the original installation.
7. Replace door onto the hinge pin on the bottom hinge. Place top hinge pin into door. Insert screws into the top hinge.

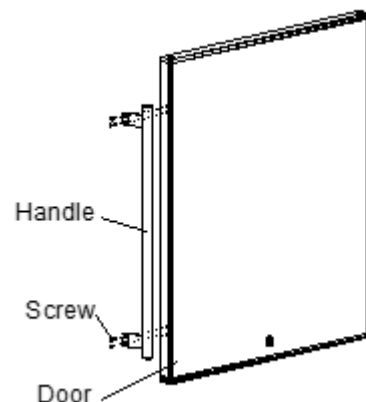

Installing the Handle

This appliance includes a handle that is not required to operate the unit. To install the handle, follow the instructions below:

1. Use a screwdriver to remove the screws on the side of door where the handle is to be installed.
2. Align the handle with the screws removed in step # 1. Tighten the screws using a Phillips head screwdriver until the handle is both flush and secured tightly against the door side. (DO NOT over-tighten as this will cause damage to the door surface.)

OPERATING YOUR APPLIANCE



It is recommended you install the appliance in a place where the ambient temperature is between 44° and 90°F (7° to 32°C). If the ambient temperature is above or below the recommended temperatures, the performance of the unit may be affected. For example, placing your unit in extremely cold or hot conditions may cause interior temperatures to fluctuate. The operating temperature range may not be reached.

NOTE: If the door of the unit is left open for more than 60 seconds, an alarm will sound. The alarm will stop once the door is closed.

Control Panel for Digital Thermostats

Refrigerators and freezers include a digital thermostat located in the kick plate of your unit.

Indicator Symbol Table:

Indicator	Symbol	Status	Meaning
Setting	Set	ON	Set parameters
		OFF	Temperature measuring and controlling
Cooling		ON	Cooling active
		OFF	Cooling inactive
		Flash	Cooling delays
Defrost		ON	Defrost active
		OFF	Defrost inactive
Dripping	drip	ON	Dripping active
		OFF	Dripping inactive
Measurement unit indicator light	°C	ON	Unit of measurement display
Measurement unit indicator light	°F	ON	Unit of measurement display

- Press and hold the SET and the LIGHT keys for three seconds to turn the unit on/off.



- To adjust the temperature, press and hold the SET key for 3 seconds. When the display shows **St**, you can raise the temperature by pressing the LIGHT key or lower it by pressing the MENU ADJUST key, shown below. Press the ❄️ key, or press no key for 30 seconds, to exit. The temperature set-point will be saved automatically.



- Press the ❄️ key to view the temperature.
- Press and hold the ⚙️ and 🌙 keys for three second to change the temperature display between °C and °F.

NOTE: When you use the unit for the first time or restart the unit after it has been shut off for a long time, there could be a few degrees variance between the temperature you select and the one indicated on the LED readout. This is normal and is due to the length of the activation time. There should not be a problem once the unit has been running for a few hours.

Setting Parameters:

Several temperature parameter settings can be adjusted from the defaults, if you choose to do so. To adjust these parameters:

1. Press and hold the SET key for 3 second.
2. When the panel displays **St**, press the LIGHT key, and the panel will display **Po**.
3. Press the SET key, and 00 will display.
4. Enter the administrator password (55).
5. Press the SET key, and the panel will display **Po**.
6. Press the ⚙️ and 🌙 keys to select the appropriate parameter (**do2**, **A5**, **A6**, etc.).
7. After selecting a parameter, press the SET key to set its value. Use the ⚙️ and 🌙 keys to adjust the value, the press the SET key to return to the menu.
8. Press the ❄️ key, or press no key for 30 seconds, to exit. The temperature set-point will be saved automatically.

A full list of parameters is listed on pages 13-15. These parameters are listed as a reference for service technicians, however, several commonly-used parameters are listed on page 9.



Door Open Alarm:

Your unit will sound an alarm when the door is open for longer than 60 seconds. To disable this:

1. Follow the Setting Parameters instructions on page 8.
2. Find parameter **do2**.
3. The default for the unit is set at **1** (Enabled).
4. To disable the alarm, set the parameter to **0** (Disabled).
5. Press the  key, or press no key for 30 seconds, to exit. The temperature set-point will be saved automatically.



Low Temperature Alarm:

To set a low temperature alarm:

1. Follow the Setting Parameters instructions on page 8.
2. Find parameter **A5**.
3. Use the Use the  and  keys to adjust the temperature.
4. Press the  key, or press no key for 30 seconds, to exit. The temperature set-point will be saved automatically.

High Temperature Alarm:

To set a high temperature alarm:

5. Follow the Setting Parameters instructions on page 8.
6. Find parameter **A6**.
7. Use the Use the  and  keys to adjust the temperature.
8. Press the  key, or press no key for 30 seconds, to exit. The temperature set-point will be saved automatically.

Alarms

Various alarms will sound under certain conditions if the unit's buzzer is enabled. Below is a table listing the unit's alarm codes and causes:

Alarm Code	Causes
E1	Cabinet temperature sensor fails.
E2	Evaporator sensor fails.
E3	Condenser sensor fails.
cH	High condenser temperature alarm
rH	High cabinet temperature alarm
rL	Low cabinet temperature alarm

Controls for Dial Thermostats

- Some units in this collection include a dial thermostat located inside the unit on the upper-right side wall.
- Turn the knob clockwise from the **0 (OFF)** position toward the higher numbers for colder temperatures. Higher settings on the dial (higher numbers) mean lower temperatures (colder) in the unit.
- Changes in the ambient temperature affect temperature in the unit, so choose an appropriate setting of the thermostat dial, depending on ambient conditions.

NOTE: If the unit is unplugged, or power is lost or turned off, you must wait 3 to 5 minutes before restarting the unit. If you attempt to restart before this time delay, the unit will not start.

Defrosting

Refrigerators in this series defrost automatically in normal operating conditions. The evaporator behind the rear wall of the unit defrosts automatically. The condensate collects in the drainage channel behind the rear wall of the unit, and flows through the drainage hole into the drip tray by the compressor where it evaporates.

However, frost may accumulate on the evaporator if the unit is repeatedly opened in a high heat or high humidity location. If this frost pattern does not clear within 24 hours, your unit will require manual defrosting.

Freezer models and the freezer compartment of refrigerator-freezers require manual defrosting. For the most efficient operation and minimum energy consumption, defrost the freezer when the frost on the freezer walls is excessive or $\frac{1}{4}$ to $\frac{1}{2}$ " thick.

CAUTION: *Never use boiling water to defrost because it may damage the plastic parts. In addition, never use a sharp or metallic instrument to remove frost, as it may damage the cooling coils and will void your warranty. We recommend using a plastic scraper.*

To defrost:

1. Remove the frozen food from the freezer and place it in another cooling device
2. Turn the thermostat off and unplug your freezer, leaving the door open to help speed up the defrosting process
3. Use a sponge or toweling to remove water and melting ice from the freezer floor. Pouring warm (not boiling) water on the ice/frost may also help speed the defrosting process.
4. Clean and thoroughly dry the freezer interior
5. Close the door and plug the freezer in, resetting the thermostat to the desired setting
6. Allow several hours for the cabinet to reach the proper storage temperature

Shelves

To prevent damaging the door gasket, make sure to have the door all the way open when pulling the shelves out of the rail compartment.

- Any of the shelves can be removed to store larger items.
- When removing the shelf from the rail compartment, make sure to remove all items first. Then move the shelf to the position where the notch of the shelf is exactly under the plastic post and lift the shelf. In order to replace the shelf, repeat steps described above in reverse.

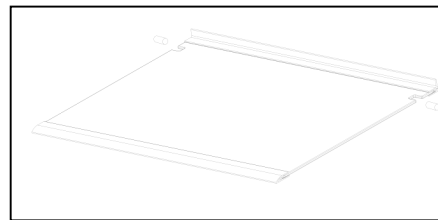

CARE AND MAINTENANCE

Cleaning your Appliance

- Turn off the power, unplug the appliance, and remove all items, including shelves.
- Wash the inside surfaces with a solution of warm water and baking soda (about 2 tablespoons of baking soda to a quart of water).
- Wash the shelves with a mild detergent solution.
- Wring excess water out of the sponge or cloth when cleaning the area where the controls are located, or any electrical parts.
- Wash the outside cabinet with warm water and mild liquid detergent. Rinse well and wipe dry with a clean soft cloth.

CAUTION: *Failure to unplug the appliance during cleaning could result in electrical shock or other personal injury.*

Power Failure

Most power failures are corrected within a few hours and should not affect the temperature of your appliance if you minimize the number of times the door is opened. If the power is going to be off for a longer period of time, you need to take the proper steps to protect the contents.

Vacations

- **Short vacations:** Leave the appliance operating during vacations of less than three weeks.
- **Long vacations:** If the appliance will not be used for several months, remove all items and turn off the appliance. Clean and dry the interior thoroughly. To prevent odor and mold growth, leave the door open slightly, blocking it open if necessary.

Moving your Appliance

1. Remove all items.
2. Securely tape down all loose items (shelves) inside your appliance, and tape the door shut.
3. Turn the adjustable legs up to the base to avoid damage.
4. Be sure the appliance stays secure in the upright position during transportation. Also, protect the outside of the appliance with a blanket or similar item.

Energy-Saving Tips

- The appliance should be located in the coolest area of the room or outdoor location, away from heat-producing appliances and out of direct sunlight.
- Ensure that the unit is adequately ventilated. Never cover air vents.
- Do not keep the door open any longer than necessary.
- Let hot foods cool to room temperature before placing in the unit. Overloading the unit forces the compressor to run longer.
- Be sure to wrap foods properly, and wipe containers dry before placing them in the unit. This cuts down on frost build-up inside the unit.
- Unit shelves and storage bins should not be lined with aluminum foil, wax paper, or paper toweling. Liners interfere with cold air circulation, making the unit less efficient.
- Organize and label food to reduce door opening and extended searches.

TROUBLESHOOTING

You can solve many common problems easily, saving you the cost of a possible service call. Try the suggestions below to see if you can solve the problem before calling the servicer.

Troubleshooting Guide

PROBLEM	POSSIBLE CAUSE	REMEDY
Appliance does not operate.	<ul style="list-style-type: none"> Appliance is not connected to a power supply. The appliance is turned off. Tripped circuit breaker or a blown fuse. 	<ul style="list-style-type: none"> Connect the appliance. Switch on the appliance. Switch on circuit breaker or replace fuse.
Appliance is not cold enough.	<ul style="list-style-type: none"> The temperature is not set correctly. The ambient temperature could require a lower temperature setting. The door was opened too often. The door was not closed completely. Door is not hermetically sealed. The condenser is too dirty. The ventilation opening is blocked or too dusty. 	<ul style="list-style-type: none"> Check the set temperature. Set a lower temperature. Do not open the door more often than necessary. Close door properly. Check the door seal and clean or replace. Clean the condenser when necessary. Clear the obstructions and clean off the dust.
Appliance turns itself on and off frequently.	<ul style="list-style-type: none"> The room temperature is higher than average. A large amount of food has been added to the unit. The door is open too often. The door is not closed completely. The door gasket does not seal properly. 	<ul style="list-style-type: none"> Put the appliance in a cooler place. Leave the appliance to work for a while until the set temperature has been reached. Do not open the door more often than necessary. Close door properly. Check the door seal and clean or replace.
Vibrations	<ul style="list-style-type: none"> The appliance is not properly leveled. 	<ul style="list-style-type: none"> Level the appliance with the adjustable feet.
The appliance seems to make too much noise.	The rattling noise may come from the flow of the refrigerant, which is normal. As each cycle ends, you may hear gurgling sounds caused by the flow of refrigerant in your appliance. If temperature fluctuations occur, the contraction and expansion of the inner walls may cause popping and crackling noises.	
	<ul style="list-style-type: none"> The appliance is not properly level. 	<ul style="list-style-type: none"> Level the appliance with the adjustable feet.
The door will not close properly.	<ul style="list-style-type: none"> The appliance is not properly level. The door was reversed and not properly installed. The gasket is dirty. The shelves are out of position. 	<ul style="list-style-type: none"> Level the appliance with the adjustable feet. Check the door hinge and reassemble correctly. Clean the door gasket. Check the shelves and refit correctly.

If you've checked the table above and find that you still need help with your appliance, call our Customer Service facility at **800-932-4267** between 9:00AM and 5:00PM ET. We will do our best to answer your question.

PARAMETER TABLE

Item	Description	Setting Range	Default	Unit
User Menu				
St	Temperature set-point	Low set-point~High set-point	4°C	°C/°F
Po	Administrator menu password	00~99(Default password is 55 and unchangeable)	00	/
Administrator Menu				
C1	Differential	0.5°C~9.0°C	4°C	°C/°F
		1°F~20°F		
C2	Compressor start delay between last switch-off and the successive switch-on	0~60	5	min
C3	Compressor start delay after switch-on of the device	0~90	5	min
C4	Calibration temperature 1. Temperature value added to the value read by cabinet sensor	-10.0°C~10.0°C	0.0°C	°C/°F
		-20°F~20°F		
C5	Low set-point. Minimum possible set-point	-50°C ~Temperature set-point	-2°C	°C/°F
		-58°F ~Temperature set-point		
C6	High set-point. Maximum possible set-point	Temperature set-point ~ -85°C	22°C	°C/°F
		Temperature set-point ~ -185°F		
C7	Maximum standby time after compressor start delay①	0~90 0: Disabled	9	min
C8	Minimum compressor on time	0~90 0: Disabled	0	min
d1	Evaporator sensor options	0: Disable 1: Enable	0	/
d2	Calibration temperature 2. The temperature value added to the value read by the evaporator sensor.	-10.0°C~10.0°C	0.0°C	°C/°F
		-20°F~20°F		
d3	Defrost counting type	0: Compressor operating time 1: Controller power-on time	1	/
d4	Defrost interval time	0~90 0: Disable defrost	2	hour
d5	Display during defrost	0: Displays cabinet temperature; 1: Displays dEF during defrost and d9, displays cabinet temperature after d9 elapses; 2: Displays dEF during defrost and dripping; 3. Displays cabinet temperature at defrost start during defrost and dripping. 4.	2	/
d6	Maximum defrost duration	1~90	25	min

d7	Defrost stop temperature	0°C ~ 50°C	12°C	°C/°F
		32°F ~122°F		
d8	Dripping time	0~60 0: Disabled	2	min
d9	Delay time for displaying the cabinet temperature after defrost	0~90	10	min
d10	Defrost start delay	0~60 0: Disabled	10	min
d11	Defrost mode	0: Electric defrost 1: Hot gas defrost	0	/
F1	Fan working mode	0: Fan and compressor run or stop simultaneously; 1: Fan runs continuously and stops during defrost; 2: Fan runs continuously and stops during defrost and dripping; 3: Fan runs continuously, stops during defrost and delays after defrost; 4: Fan is controlled by defrost sensor temperature, and stops during defrost.	3	/
F2	Fan start delay after the controller is energized	0~60	3	min
F3	Fan delay time after defrost	0~60 0: Disabled	2	min
A1	Duty cycle mode in the event of a faulty cabinet sensor	0: Disable 1: Enable	1	/
A2	Compressor off time in duty cycle mode	1~60	5	min
A3	Compressor on time in duty cycle mode	1~60	30	min
A4	Buzzer beep	0: Disable 1: Enable	1	/
A5	Low alarm temperature(cabinet)	-50°C ~ High alarm temperature (cabinet)	-10°C	°C/°F
		-58°F ~ High alarm temperature (cabinet)		
A6	High alarm temperature(cabinet)	Low alarm temperature(cabinet) ~ 85°C	24°C	°C/°F
		Low alarm temperature(cabinet) ~ 185°F		
A7	Alarm delay	0~60	20	3min
A8	Alarm delay after switch-on of the device	0~60	40	3min
A9	High alarm offset	1°C ~30°C	10°C	°C/°F
		1°F~ 60°F		
A10	Low alarm offset	1°C ~30°C	5°C	°C/°F
		1°F~ 60°F		
A11	Cabinet temperature alarm	0: Absolute temperature point 1: Temperature set-point + alarm offset	0	/

A12	Light/Alarm relay options	0: Light 1: Alarm	0	/
do1	Door switch control options	0: Door switch is disabled; 1: Fan stops running when the door is open; 2: Light is turned on/off when the door is open/closed; 3: Fan stops running and light is turned on when the door is open. Light is turned off when the door is closed; 4: When the door is open, it inputs as synchronous defrost signal, i.e. defrost starts.	0	/
do2	Whether buzzer responds when the door is open?	0: No 1: Yes	0	/
do3	Door switch alarm delay	0-99min	3	min
cd1	Condenser sensor options	0: Disable 1: Enable	0	/
cd2	High alarm temperature (condenser)	30°C ~90°C	55°C	°C/°F
		86°F~ 194°F		
cd3	High alarm temperature differential (condenser)	1°C ~15°C	5°C	°C/°F
		2°F~ 30°F		
u1	Celsius / Fahrenheit②	00:°F	01	/
		01:°C		

LIMITED WARRANTY

ONE-YEAR LIMITED WARRANTY

Within the 48 contiguous United States, for one year from the date of purchase, when this appliance is operated and maintained according to instructions attached to or furnished with the product, warrantor will pay for factory-specified parts and repair labor to correct defects in materials or workmanship. Service must be provided by a designated service company. Outside the 48 states, all parts are warranted for one year from manufacturing defects. Plastic parts, shelves and cabinets are warranted to be manufactured to commercially acceptable standards, and are not covered from damage during handling or breakage.

5-YEAR COMPRESSOR WARRANTY

1. The compressor is covered for 5 years.
2. Replacement does not include labor.

ITEMS WARRANTOR WILL NOT PAY FOR:

1. Service calls to correct the installation of your appliance, to instruct you how to use your appliance, to replace or repair fuses or to correct wiring or plumbing.
2. Service calls to repair or replace appliance light bulbs or broken shelves. Consumable parts (such as filters) are excluded from warranty coverage.
3. Damage resulting from accident, alteration, misuse, abuse, fire, flood, acts of God, improper installation, installation not in accordance with electrical or plumbing codes, or use of products not approved by warrantor.
4. Replacement parts or repair labor costs for units operated outside the United States.
5. Repairs to parts or systems resulting from unauthorized modifications made to the appliance.
6. The removal and reinstallation of your appliance if it is installed in an inaccessible location or is not installed in accordance with published installation instructions.

DISCLAIMER OF IMPLIED WARRANTIES; LIMITATION OF REMEDIES

CUSTOMER'S SOLE AND EXCLUSIVE REMEDY UNDER THIS LIMITED WARRANTY SHALL BE PRODUCT REPAIRS PROVIDED HEREIN. IMPLIED WARRANTIES, INCLUDING WARRANTIES OF MERCHANTABILITY OR FITNESS FOR A PARTICULAR PURPOSE, ARE LIMITED TO ONE YEAR. WARRANTOR SHALL NOT BE LIABLE FOR INCIDENTAL OR CONSEQUENTIAL DAMAGES. SOME STATES DO NOT ALLOW THE EXCLUSION OR LIMITATION OF INCIDENTAL OR CONSEQUENTIAL DAMAGES, OR LIMITATIONS ON THE DURATION OF IMPLIED WARRANTIES OF MERCHANTABILITY OR FITNESS, SO THESE EXCLUSIONS OR LIMITATIONS MAY NOT APPLY TO YOU. THIS WARRANTY GIVES YOU SPECIFIC LEGAL RIGHTS AND YOU MAY ALSO HAVE OTHER RIGHTS, WHICH VARY FROM STATE TO STATE.



WARNING: This product can expose you to chemicals including Nickel (Metallic) which is known to the State of California to cause cancer.

For more information go to www.P65Warnings.ca.gov

Note: Nickel is a component in all stainless steel and some other metallic compositions.

FELIX STORCH, INC.
770 Garrison Avenue
Bronx, NY10474
Phone: (718) 893-3900
Fax: (844) 478-8799
www.summitappliance.com

SUMMIT

For parts and accessory ordering,
troubleshooting and helpful hints, visit:
www.summitappliance.com/support

Revised May 2020