



Pre-Rinse Units
B-0131-BC-28H

TAG:

EasyInstall Pre-Rinse Unit

Architect/Engineering Specifications:

8" wall mount mixing faucet with polished chrome plated brass body, 26" riser, overhead swivel arm, 28" flexible stainless steel hose, heat resistant handle, 0.65 GPM low flow spray valve, compression cartridges with spring checks, lever handles, 1/2" NPT female inlets, 6" adjustable wall bracket and spray valve holder. Certified to ASME A112.18.1/CSA B125.1, NSF 61-Section 9 and NSF 372. EPAAct 2005 compliant.

Job Name _____
 Model Specified _____ Quantity _____
 Variations Specified _____
 Date _____

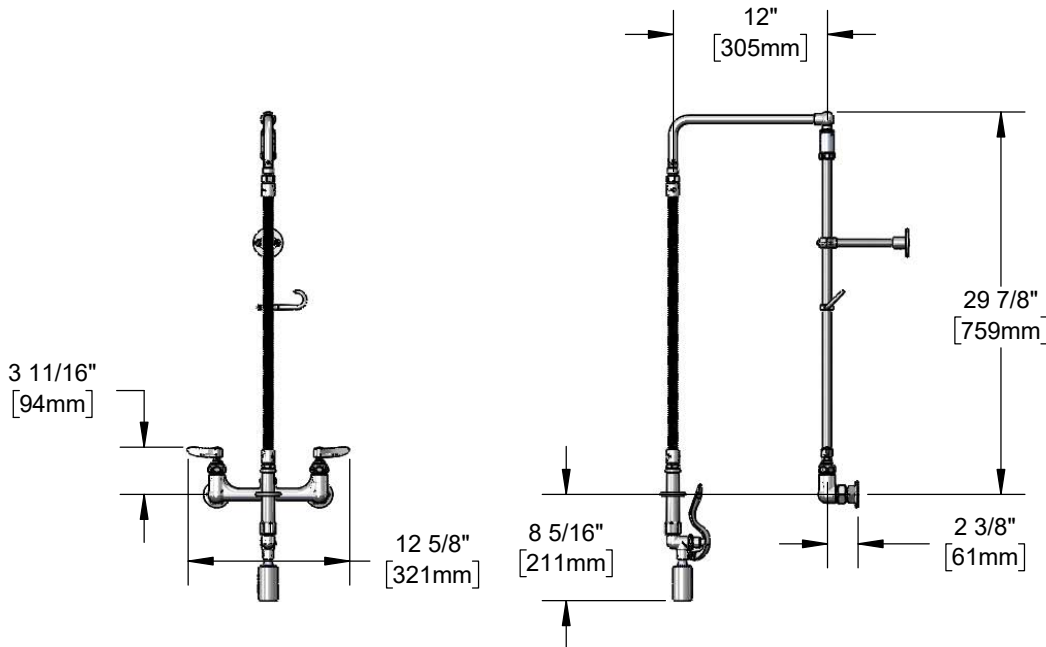

Features & Benefits:

- 8" wall mount polished chrome plated brass body
- 26" EasyInstall riser w/ 12" overhead swivel arm
- 28" flexible stainless steel hose w/ heat resistant gray handle and hold down ring
- 0.65 GPM low flow spray valve
- Quarter-turn Eterna compression cartridges w/ spring checks to prevent cross flow of water
- Lever handles w/ color coded indexes
- 1/2" NPT female eccentric inlets with Ø 2" flanges
- Adjustable centers from 7 3/4" to 8 1/4"
- 6" adjustable wall bracket
- Material: Polished chrome plated brass body, riser, swivel arm & spray valve body, stainless steel hose and chrome plated metal handles

Product Compliance:

- ASME A112.18.1 / CSA B125.1
- NSF 61 - Section 9
- NSF 372 (Low Lead Content)
- EPAAct 2005 (PRSV)
- EPA WaterSense (PRSV)



Warranty: Three Year (Limited)

Performance Data:

- Pressure: 20 - 125 psi
- Temperature: 40 °F - 140 °F
- Flow Rate: 0.65 GPM @ 60 psi

Optional Cartridges With Checks

- Quarter-Turn Cerama w/ Check Valve
- Quarter-Turn Eterna w/ Spring Check (Standard)

Optional Handles

- 4" Wrist Action
- Lever(Standard)
- 4-Arm

Optional Pre-Rinse Spray Valves

- B-0107 (1.42 GPM)
- B-0107-C (0.65 GPM) (Standard)
- B-0107-J (1.07 GPM)
- B-0108 (1.07 GPM)
- B-0108-C (0.65 GPM)



T&S BRASS AND BRONZE WORKS, INC.



• 2 Saddleback Cove • Travelers Rest, SC 29690
 Ph 800-476-4103 • Fax 864-834-3518
 • Simi Valley, CA • Ph 800-423-0150 • www.tsbrass.com

Date: 02/28/18