



Architect/Engineering Specifications:

8" wall mount mixing faucet with polished chrome plated brass body, add-on faucet with compression cartridge and lever handle, 12" swing nozzle with stream regulator outlet, 18" riser, 44" flexible stainless steel hose, 0.65 GPM low flow spray valve with insulated grip handle, compression cartridges with spring checks, lever handles, 1/2" NPT female inlets, spray valve holder and overhead spring. Certified to ASME A112.18.1/CSA B125.1, NSF 61-Section 9 and NSF 372. EPAAct 2005 compliant.

Job Name _____

Model Specified _____ Quantity _____

Variations Specified _____

Date _____

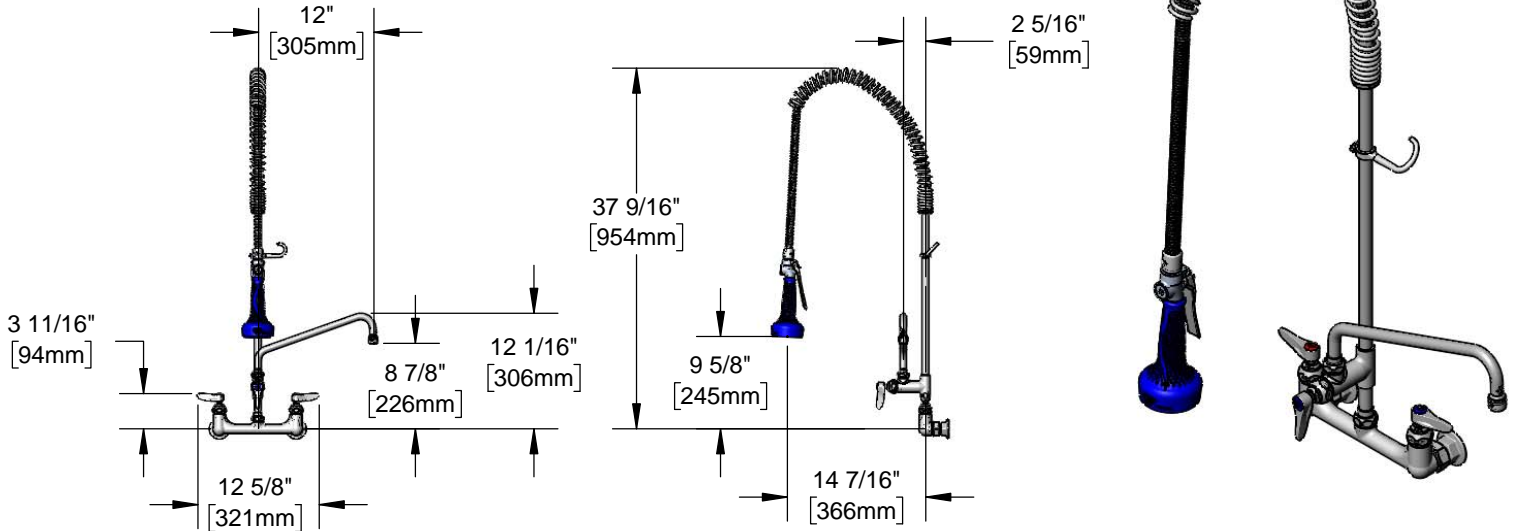

Features & Benefits:

- 8" wall mount mixing faucet w/ polished chrome plated brass body
- EasyInstall add-on faucet w/ polished chrome plated brass body
- 12" swing nozzle w/ stream regulator outlet, Series 1
- 18" rigid riser
- 44" flexible stainless steel hose
- 0.65 GPM low flow JeTSpray spray valve with insulated grip handle, stainless steel trigger and trigger lock
- Quarter-turn Eterna compression cartridges with spring checks to prevent cross flow of water
- Lever handles w/ color coded indexes
- 1/2" NPT female eccentric inlets with Ø 2" flanges
- Adjustable centers from 7 3/4" to 8 1/4"
- Material: Polished chrome plated brass body, tubular nozzle, add-on faucet body, riser & spray valve body, stainless steel hose, and chrome plated metal handles

Product Compliance:

- ASME A112.18.1 / CSA B125.1
- NSF 61 - Section 9
- NSF 372 (Low Lead Content)
- EPAAct 2005 (PRSV)
- EPA WaterSense (PRSV)



Warranty: Three Year (Limited)

Performance Data:

- Pressure: 20 - 125 psi
- Temperature: 40°F - 140°F
- Flow Rate:
 - Spray Valve: 0.65 GPM @ 60 psi
 - Add-On Faucet: 9.73 GPM @ 60 psi

Optional Cartridges With Checks

- Quarter-Turn Cerama w/ Check Valve
- Quarter-Turn Eterna w/ Spring Check (Standard)

Optional Handles

- 4" Wrist Action
- Lever (Standard)
- 4-Arm

Optional Pre-Rinse Spray Valves

- B-0107 (1.42 GPM)
- B-0107-C (0.65 GPM)
- B-0107-J (1.07 GPM)
- B-0108 (1.48 GPM)
- B-0108-C (0.65 GPM) (Standard)

Optional Add-On Faucet Outlets (Series 1 / VR Series 6)

GPM	Aerated	VR Aerated (VR Laminar)
1.0	<input type="checkbox"/> B-0199-01-F10	<input type="checkbox"/> B-0199-06-F10
1.5	<input type="checkbox"/> B-0199-01-WS	<input type="checkbox"/> B-0199-06-WS
2.2	<input type="checkbox"/> B-0199-01	<input type="checkbox"/> B-0199-06

