



Architect/Engineering Specifications:

8" wall mount mixing faucet with polished chrome plated brass body, add-on faucet with compression cartridge and lever handle, less nozzle, 18" riser, 44" flexible stainless steel hose with heat resistant handle, 1.42 GPM spray valve, compression cartridges with spring checks, lever handles, 1/2" NPT female inlets, 6" adjustable wall bracket, spray valve holder and overhead spring. Certified to ASME A112.18.1/CSA B125.1, NSF 61-Section 9 and NSF 372. EPAAct 2005 compliant.

Job Name _____

Model Specified _____ Quantity _____

Variations Specified _____

Date _____

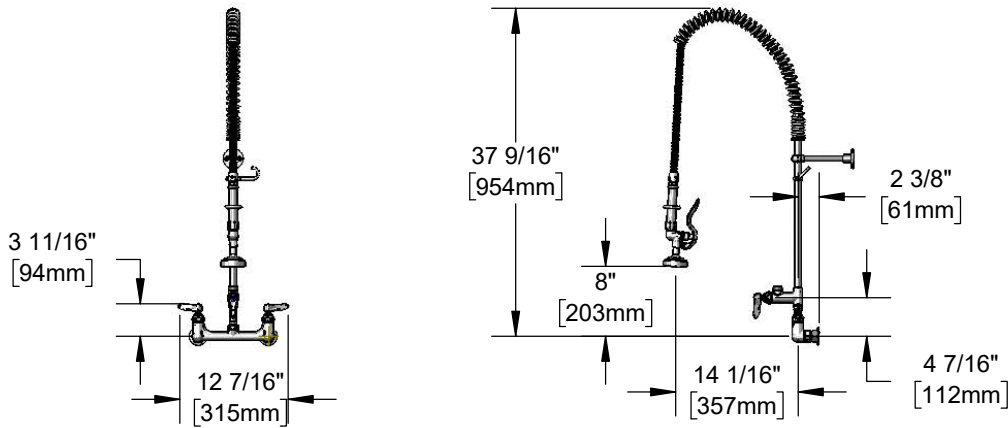

Features & Benefits:

- 8" wall mount mixing faucet w/ polished chrome plated brass body
- EasyInstall add-on faucet w/ polished chrome plated brass body
- Accepts all T&S swing nozzles
- 18" rigid riser
- 44" flexible stainless steel hose with heat resistant gray handle and hold down ring
- 1.42 GPM spray valve
- Quarter-turn Eterna compression cartridges with spring checks to prevent cross flow of water
- Lever handles w/ color coded indexes
- 1/2" NPT female eccentric inlets with Ø 2" flanges
- Adjustable centers from 7 3/4" to 8 1/4"
- 6" adjustable wall bracket
- Material: Polished chrome plated brass body, add-on faucet body, riser & spray valve body, stainless steel hose, and chrome plated metal handles

Product Compliance:

- ASME A112.18.1 / CSA B125.1
- NSF 61 - Section 9
- NSF 372 (Low Lead Content)
- EPAAct 2005 (PRSV)



Warranty: Three Year (Limited)

Performance Data:

- Pressure: 20 - 125 psi
 - Temperature: 40 °F - 140 °F
 - Flow Rate:
 - Spray Valve: 1.42 GPM @ 60 psi
 - Add-On Faucet, Less Nozzle: 9.46 GPM @ 60 psi
- (Outlet Device &/or Final Configuration May Reduce Flow Rate)

Optional Cartridges With Checks

- Quarter-Turn Cerama w/ Check Valve
- Quarter-Turn Eterna w/ Spring Check (Standard)

Optional Add-On Faucet Outlets (Series 1 / VR Series 6)

GPM	Aerated	VR Aerated
1.0	<input type="checkbox"/> B-0199-01-F10	<input type="checkbox"/> B-0199-06-F10
1.5	<input type="checkbox"/> B-0199-01-WS	<input type="checkbox"/> B-0199-06-WS
2.2	<input type="checkbox"/> B-0199-01	<input type="checkbox"/> B-0199-06

Optional Handles

- 4" Wrist Action
- Lever (Standard)
- 4-Arm

Optional Pre-Rinse Spray Valves

- B-0107 (1.42 GPM) (Standard)
- B-0107-C (0.65 GPM)
- B-0107-J (1.07 GPM)
- B-0108 (1.07 GPM)
- B-0108-C (0.65 GPM)

T&S Swing Nozzles

- 059X 6" Swing Nozzle
- 060X 8" Swing Nozzle
- 061X 10" Swing Nozzle
- 062X 12" Swing Nozzle
- 063X 14" Swing Nozzle
- 064X 16" Swing Nozzle
- 065X 18" Swing Nozzle
- 066X 12" Double Joint Swing Nozzle
- 067X 15" Double Joint Swing Nozzle
- 068X 18" Double Joint Swing Nozzle
- 069X 24" Double Joint Swing Nozzle

T&S Swivel Goosenecks (D x K)

- 131X 2 13/16" x 2 9/16" Swivel Gooseneck
- 132X 2 5/8" x 5 7/16" Swivel Gooseneck
- 133X 5 11/16" x 6 1/4" Swivel Gooseneck
- 135X 8 3/4" x 5 5/8" Swivel Gooseneck

