

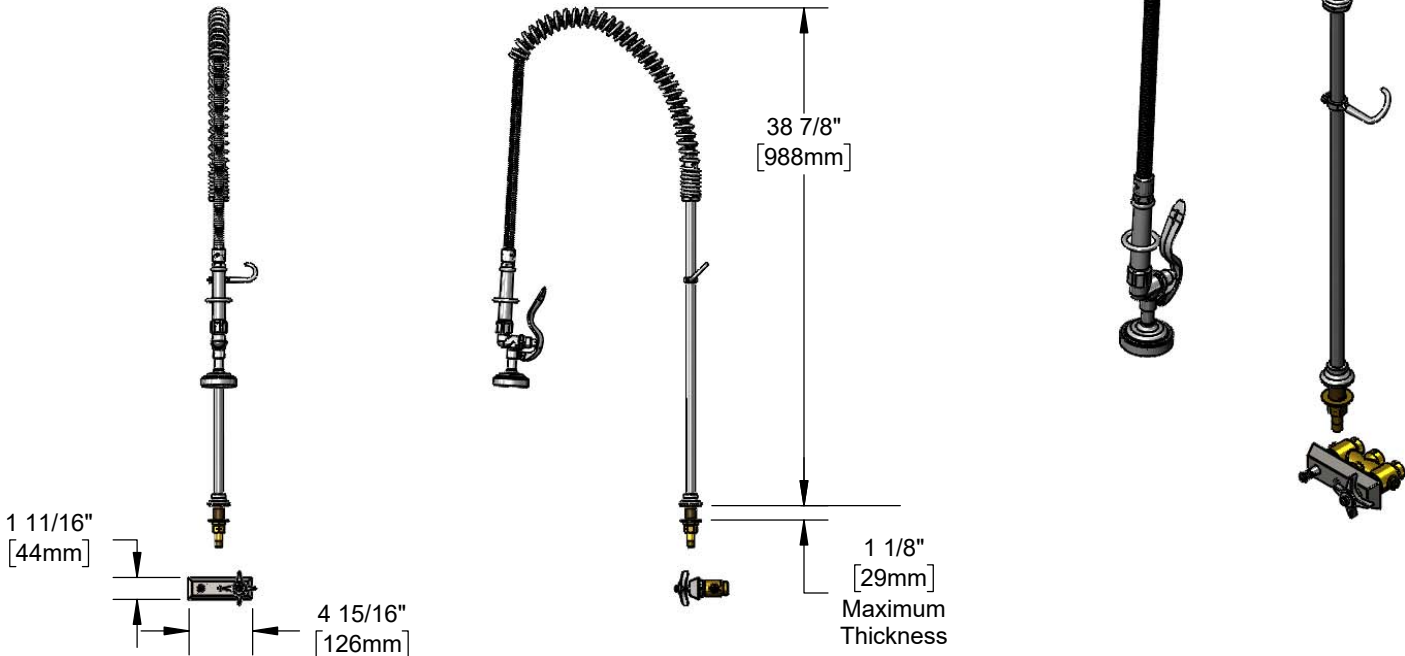

#### Architect/Engineering Specifications:

Single hole deck mount dummy pre-rinse and remote control valve with polished chrome plated brass bodies, 24" riser, 44" flexible stainless steel hose with heat resistant handle, 1.42 GPM spray valve, compression cartridges and spray valve holder. Certified to ASME A112.18.1/CSA B125.1, NSF 61-Section 9 and NSF 372. EPAAct 2005 compliant.

Job Name \_\_\_\_\_  
 Model Specified \_\_\_\_\_ Quantity \_\_\_\_\_  
 Variations Specified \_\_\_\_\_  
 Date \_\_\_\_\_



#### Features & Benefits:

- Single hole deck mount dummy pre-rinse and remote control valve w/ polished chrome plated brass bodies
- 24" riser
- 44" flexible stainless steel hose w/ heat resistant gray handle
- 1.42 GPM spray valve
- Concealed mixing faucet w/ Eterna cartridges
- 4-arm handles w/ color coded indexes
- Piping provided by others
- 1/2" NPSM shank w/ tailpiece and nut for 1/4" NPT connections
- Material: Polished chrome plated brass bodies, riser & spray valve head, stainless steel hose, and chrome plated metal pedals

#### Product Compliance:

- ASME A112.18.1 / CSA B125.1
- NSF 61 - Section 9
- NSF 372 (Low Lead Content)
- EPAAct 2005 (PRSV)

#### Warranty: One Year (Limited)

#### Performance Data:

- Pressure: 20 - 125 psi
- Temperature: 40 °F - 140 °F
- Flow Rate: 1.42 GPM @ 60 psi



#### Optional Pre-Rinse Spray Valves

- B-0107 (1.42 GPM) (Standard)
- B-0107-C (0.65 GPM)
- B-0107-J (1.07 GPM)
- B-0108 (1.07 GPM)
- B-0108-C (0.65 GPM)

#### Optional Cartridges

- Quarter-Turn Cerama
- Eterna (Standard)
- Quarter-Turn Eterna

