



Swivel/Rigid Sink and Pantry Faucets

B-0325-134X-CR4

TAG:

Double Pantry Faucet

Architect/Engineering Specifications:

4" deck mount mixing faucet with polished chrome plated brass body, 7 3/4" swivel/rigid gooseneck with stream regulator outlet, ceramic cartridges with check valves, wrist action handles and 1/2" NPT female inlets. Certified to ASME A112.18.1/CSA B125.1, NSF 61-Section 9 and NSF 372. Meets ADA ANSI/ICC A117.1 requirements.

Job Name _____
 Model Specified _____ Quantity _____
 Variations Specified _____
 Date _____

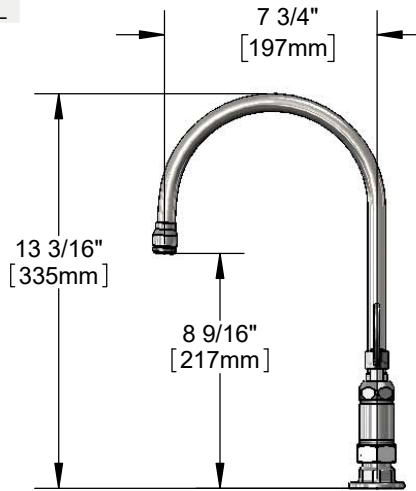
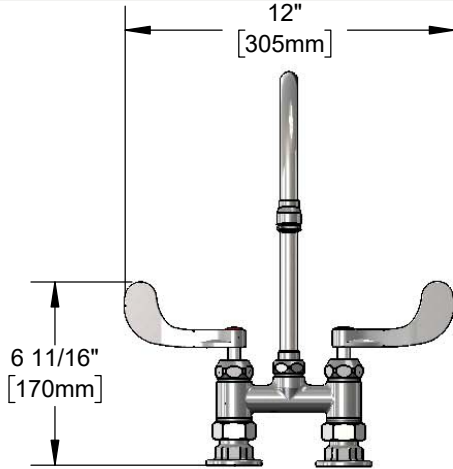

Features & Benefits:

- 4" deck mount mixing faucet with polished chrome plated brass body
- 7 3/4" swivel/rigid gooseneck
- Includes lock washer to convert to rigid
- Stream regulator outlet, Series 2
- Quarter-turn Cerama cartridges w/ check valves to prevent cross flow of water
- 4" wrist action handles w/ color coded indexes
- 1/2" NPT female eccentric inlets w/ $\phi 2$ " flanges
- Material: Polished chrome plated brass body & tubular spout and chrome plated metal handles

Product Compliance:

- ASME A112.18.1 / CSA B125.1
- NSF 61 - Section 9
- NSF 372 (Low Lead Content)
- ANSI A117.1 (ADA)



Warranty: One Year (Limited)

- Cerama Cartridge: Lifetime (Limited)

Performance Data:

- Pressure: 20 - 125 psi
- Temperature: 40 °F - 180 °F
- Flow Rate: 9.8 GPM @ 60 psi



ADA Compliant

Optional Outlets (Series 2 / VR Series 7)

GPM	Aerated	Non-Aerated (Laminar)	VR Aerated	VR Non-Aerated (VR Laminar)
0.35	N/A	<input type="checkbox"/> B-0199-02-N035	N/A	<input type="checkbox"/> B-0199-07-N035
0.5	N/A	<input type="checkbox"/> B-0199-02-N05	N/A	<input type="checkbox"/> B-0199-07-N05
1.0	<input type="checkbox"/> B-0199-02-F10	N/A	<input type="checkbox"/> B-0199-07-F10	N/A
1.2	<input type="checkbox"/> B-0199-02-F12	N/A	<input type="checkbox"/> B-0199-07-F12	N/A
1.5	<input type="checkbox"/> B-0199-02-WS	N/A	<input type="checkbox"/> B-0199-07-WS	N/A
2.2	<input type="checkbox"/> B-0199-02	N/A	<input type="checkbox"/> B-0199-07	N/A

Optional Handles

- 4" Wrist Action (Standard)
- Lever
- 4-Arm

Optional Cartridges With Checks

- Quarter-Turn Cerama w/ Check Valve (Standard)
- Quarter-Turn Eterna w/ Spring Check



T&S BRASS AND BRONZE WORKS, INC.



• 2 Saddleback Cove • Travelers Rest, SC 29690
 Ph 800-476-4103 • Fax 864-834-3518
 • Simi Valley, CA • Ph 800-423-0150 • www.tsbrass.com

Date: 05/01/18