



Gas burning pizza brickoven



Manufacturer:
Univex Corporation
3 Old Rockingham Rd. Salem NH 03079
603-893-6191

USER MANUAL AND MAINTENANCE GUIDE

This user manual is part of the machine and should be kept in proper condition in order to maintain its integrity and to allow for consultation during the equipment's life cycle.

This manual is for all Univex Static Deck Dome Ovens

WARNING: Read the instructions before using the equipment.

**REVIEW CAREFULLY THIS MANUAL BEFORE
CARRYING OUT ANY OPERATION ON THE EQUIPMENT**





Gas burning pizza brickoven

The manufacturer has the right to make changes to the production model and manual without the obligation to update previous production models and manuals.

Please read this entire manual before installing the oven. Failure to follow instructions may result in property damage, bodily injury or even death. Contact your local building or fire officials about restrictions and installation inspections in your area.

FOR YOUR SAFETY

Do not store or use gasoline or other flammable vapour or liquids in the vicinity of this or any other appliance.

Also, always keep the area under and around this appliance free and clear of any and all combustible materials. Do not obstruct the flow of combustion and ventilation air.

DO NOT THROW THIS MANUAL AWAY

RETAIN THIS MANUAL FOR FUTURE REFERENCE.
ADDITIONAL COPIES AVAILABLE UPON REQUEST.

IMPORTANT: Consult your local gas supplier for a statement outlining a procedure to be followed in the event you smell gas. Post the statement in a prominent location.

⚠ WARNING: Improper installation, adjustment alteration, service or maintenance can result in property damage, injury or death. Read the installation, operation and maintenance instructions thoroughly before installing or servicing this equipment

It is recommended that this oven be installed, maintained and serviced by authorised professionals.

Additional copies of this manual and prompt responses to service / maintenance questions are available from Univex.



Gas burning pizza brickoven

Table of Contents

1. GENERAL NOTICE	4
1.1 Test and warranty	4
1.2 Client's responsibilities.....	4
1.3 Equipment safety	5
2. GENERAL INFORMATION	6
2.1 Definitions and icons.....	6
2.1.1 Definitions	6
2.1.2 Icons.....	7
3. Manufacturer's name and address	9
3.1 Information on technical support and maintenance	10
4. TECHNICAL INFORMATION AND SPECIFICATIONS.....	11
5. General description.....	12
6. INSTALLATION AND STORAGE.....	13
6.1 Inspections upon receipt of the equipment	13
6.2 Storage	13
7. ASSEMBLING INSTRUCTIONS	14
7.1 Clearances	14
7.2 Positioning of the oven	15
7.3 Electrical connection.....	17
7.3.1 Electrical specifications.....	18
7.4 Hydraulic connection	19
7.4.1 Gas conversions	20
8. Using the oven	24
8.1 Equipment's functions and controls	24
9. MAINTENANCE.....	29
9.1 Daily maintenance	29
9.2 Periodic maintenance	29
10. TROUBLESHOOTING	30
11. INTERVENTION REQUEST FORM - REPLACEMENT PARTS	31
12. REPLACEMENT PART LIST	32
13. ATTACHMENT LIST	32
14. WARRANTY	33



Gas burning pizza brickoven

1. GENERAL NOTICE

1.1 Test and warranty

The oven and its components have already been tested at our plant in compliance with the applicable regulations and laws, and are delivered ready for use.

Any attempt to disassemble, change or, in general, tamper with any part of the equipment will invalidate the warranty.

Any improper use of the oven, as well as any attempt to disassemble and modify the oven, can lead to accidents and therefore Univex declines any responsibility for potential injuries or damages resulting from tampering. In case of anomalies, please consult your local authorized customer service center and, more specifically, contact directly the manufacturer for help with assembling, installing or moving the equipment. The manufacturer shall be relieved from any responsibility in the following cases:

- Improper use of the equipment by inadequately trained personnel.
- Installations that are not compliant with applicable laws in the country of use and performed by non-authorized personnel.
- Scheduled routine maintenance that was not carried out or that was performed incorrectly.
- Use of non-original or non-approved replacement parts.
- Partial or total non-observance of the instructions.

The warranty is effective as per 12 months since the delivery date and covers the replacement or repair of any faulty part, except for electric or electronic components and parts. The manufacturer should be notified of any visible defect or anomaly within 5 days since the date of receipt to be able to conduct an inspection.

Any other defect that might be seen upon receipt of the oven should be notified within 5 days since it was noticed and in any case within maximum 6 months.

The buyer has the right to request the repair or replacement of the faulty parts only, since the warranty does not cover in any way the damages related to any other direct or indirect cause.

The repair and replacement of faulty parts should be requested within the maximum limit as outlined in the warranty unless otherwise specified by law.

Damaged or faulty parts will be repaired or replaced by the manufacturer. The buyer is therefore responsible for sending free of carriage charges the above-mentioned parts to the manufacturer, who will resend them to the buyer.

1.2 Client's responsibilities

The client should be held responsible for the following:

- Reading thoroughly this user manual before installing and using the equipment
- Installing and positioning correctly the oven as per instructions outlined in chapter 6 of this manual
- Observing the applicable regulations and laws for gas interconnection or use of solid fuels
- Connecting and implementing the fume extraction system / Connecting the flue pipe
- Cleaning and care of the oven
- Routine maintenance

1.3 Equipment safety

- Please read carefully this booklet and its safety guidelines on use and maintenance. This manual's aim is to share key rules and criteria with the operators in order to guarantee their safety and extend the oven's operating time. This manual shall be read and understood by all members of the personnel who have been authorized to operate on the oven before its first startup.
- This instructions booklet must be stored together with the equipment for future reference. In case you want to sell or transfer the equipment, make sure to include this booklet so that the new user can be informed about the operating instructions and related warnings. It must be stored in a safe and dry place, and should be easily accessible for consultation. In case it falls apart or gets lost, you can request a copy directly to the manufacturer; in case of doubt, please consult your local customer support center or contact directly Univex.
- This equipment is designed for baking pizzas. It should not be used for any other purpose; any other use is to be considered inappropriate.
- Maintenance, adaptation to another type of gas, startup and functional checks should be carried out only by qualified personnel.
- We recommend you to subscribe a servicing agreement with your supplier.
- Please contact an authorized technical support center to repair and request original spare parts.
- The equipment is designed for commercial use and should be used by trained personnel.
- This type of equipment is designed for use in commercial applications, such as restaurants, cafeterias, hospitals and commercial businesses, like bakeries, butcheries, etc., but it is not designed for the continuous production of food.
- The manufacturer declines any responsibility for potential damages due to non-observance of the instructions for use and maintenance, or due to inappropriate use of the equipment.

2. GENERAL INFORMATION

This user manual is part of the standard-production equipment and represents a fundamental support for its startup and appropriate use.

Read it carefully and thoroughly before installing and using the equipment.







In case of reselling, the manual shall be included as part of the equipment.

Partial reproduction of this document without the written authorization by Univex is forbidden.

2.1 Definitions and icons

Here below we illustrate a series of definitions, specific terminology and icons that have been used in this manual.

2.1.1 Definitions

Icon	Description
	Lifting and Handling Equipment Operator: the operator who has been trained to use equipments for lifting and handling materials and machines. Handling operations should be carried out according to the instructions described in this manual and in compliance with the applicable laws in the country where the equipment is used.
	First Level Operator: the operator, with no specific skills, who is able to use the equipment in normal working condition and for simple maintenance interventions.
	Mechanical Maintenance Technician: the qualified technician who has been trained to operate the equipment in normal working condition and to operate on mechanical - hydraulic - pneumatic gears in order to make adjustments, maintenance interventions, installations or repairs according to the instructions outlined in this manual.
	Electrical Maintenance Technician: the qualified technician who has been trained to carry out interventions on live electrical racks, branching boxes and electrical fittings, as well as to operate the equipment under normal working conditions and to make interventions on electrical systems for adjusting, maintenance, installation and repair operations.
	Manufacturer's Technician: the qualified technician who has been designated by the manufacturer to carry out complex operations in specific situations or, in any case, on the basis of what has been agreed upon with the user. Depending on each case, the personnel is requested to have mechanical and/or electrical and/or electronic and/or IT skills.
	Equipotential bonding
	Ground protection

2.1.2 Icons



NOTE

Shows guidelines or key information described in the user manual, that should be read carefully, for the most appropriate use of the equipment.



DANGER

Warns against the risk of injuries, included lethal accidents, or serious health damages.



CAUTION

Indicates a situation that could, even indirectly, be harmful for persons, things and the environment with consequences of economic losses.





WARNING



Indicates that you should pay special attention to the instructions. Non-observance of such warnings could lead to malfunctions or dangerous conditions or damages.

HAZARD PICTOGRAMS

Warning signs (Warning, Caution, Check)

	High voltage danger	
	Hot surface	
	Moving gears danger	

Prohibition signs (Dangerous behaviors, Danger, Make-and-Break, Emergency device)

	Prohibition to use water to extinguish fires	
	Prohibition to clean, oil, grease, repair or adjust moving gears by hand	

Mandatory signs (specific action or behavior, obligation to wear a personal safety device)

	Mandatory protective gloves	
---	-----------------------------	--

3. MANUFACTURER'S NAME AND ADDRESS

This product has been manufactured by:





Forni Ceky Srl
 Via industriale 21/23
 25030 Lograto (BS) ITALY
 Tel 030.9972249 FAX 030.9972818
 ceky@ceky.it www.ceky.it

The plate on the oven front face includes all the identification data related to the oven itself.

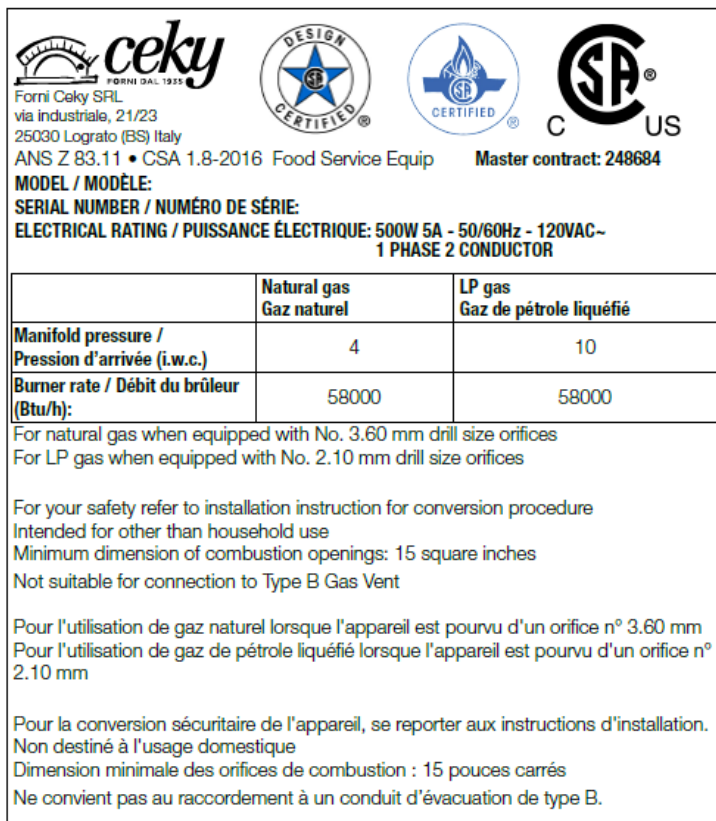
Figure 3.1 shows a sample plate that is applied to the frontal face of the oven, near the connection box: the information shown is exclusively indicative.

Fig.3.1 Sample plate



Forni Ceky SRL
 via industriale, 21/23
 25030 Lograto (BS) Italy
 ANS Z 83.11 • CSA 1.8-2016 Food Service Equip **Master contract: 248684**

MODEL / MODÈLE:
SERIAL NUMBER / NUMÉRO DE SÉRIE:
ELECTRICAL RATING / PUISSANCE ÉLECTRIQUE: 500W 5A - 50/60Hz - 120VAC~
1 PHASE 2 CONDUCTOR

	Natural gas Gaz naturel	LP gas Gaz de pétrole liquéfié
Manifold pressure / Pression d'arrivée (i.w.c.)	4	10
Burner rate / Débit du brûleur (Btu/h):	58000	58000

For natural gas when equipped with No. 3.60 mm drill size orifices
 For LP gas when equipped with No. 2.10 mm drill size orifices

For your safety refer to installation instruction for conversion procedure
 Intended for other than household use
 Minimum dimension of combustion openings: 15 square inches
 Not suitable for connection to Type B Gas Vent

Pour l'utilisation de gaz naturel lorsque l'appareil est pourvu d'un orifice n° 3.60 mm
 Pour l'utilisation de gaz de pétrole liquéfié lorsque l'appareil est pourvu d'un orifice n° 2.10 mm

Pour la conversion sécuritaire de l'appareil, se reporter aux instructions d'installation.
 Non destiné à l'usage domestique
 Dimension minimale des orifices de combustion : 15 pouces carrés
 Ne convient pas au raccordement à un conduit d'évacuation de type B.



It is absolutely forbidden to remove or tamper with the plate; in case of accidental damage, please contact the manufacturer to request a copy.

3.1 Information on technical support and maintenance

In case of failures or malfunctions, please contact our Customer Support Center:

[Univex Corporation](#)
[603-893-6191](#)
service@univexcorp.com

For communications or requests of information or replacement parts, please send the "REPLACEMENT PART ORDERING, FAULT REPORTING, INFORMATION" form in the Attachment 1 to our customer support center.



To be covered for the entire duration of the warranty period, the buyer should follow strictly the instructions outlined in this manual. In case of non-observance, Univex is relieved from any responsibility for inconveniences or anomalies or damages to the equipment or to third parties.



In order to adapt the equipment to technological advances and to specific needs at production level, the manufacturer can decide, without prior notice, to make any change on the equipment without the obligation to update previous production models and manuals.

Furthermore, although the illustrations shown in this manual are slightly different from the equipment you own, its safety and operating instructions are always guaranteed.



Gas burning pizza brickoven

4. TECHNICAL INFORMATION AND SPECIFICATIONS

DOME39 S-R-C-D-I

Natural gas	Total Input Rate (Btu/hr)	58000
	N. of burners and input rate (Btu/hr)	1 x 58000
	Manifold pressure (iwc)	4
	Nozzle orifices 1/100mm	360
	Air adjustment mm	8
LP Gas	Total Input Rate (Btu/hr)	58000
	N. of burners and input rate (Btu/hr)	1 x 58000
	Manifold pressure (iwc)	10
	Nozzle orifices 1/100mm	210
	Air adjustment mm	Open

DOME47 S-R-C-D-I / DOME51 S-R-C-D-I

Natural gas	Total Input Rate (Btu/hr)	92500
	N. of burners and input rate (Btu/hr)	1 x 92500
	Manifold pressure (iwc)	4
	Nozzle orifices 1/100mm	510
	Air adjustment mm	8
LP Gas	Total Input Rate (Btu/hr)	92500
	N. of burners and input rate (Btu/hr)	1 x 92500
	Manifold pressure (iwc)	10
	Nozzle orifices 1/100mm	280
	Air adjustment mm	Open

DOME55 S-R-C-D-I / DOME59 S-R-C-D-I

Natural gas	Total Input Rate (Btu/hr)	97500
	N. of burners and input rate (Btu/hr)	1 x 97500
	Manifold pressure (iwc)	4
	Nozzle orifices 1/100mm	540
	Air adjustment mm	8
LP Gas	Total Input Rate (Btu/hr)	97500
	N. of burners and input rate (Btu/hr)	1 x 97500
	Manifold pressure (iwc)	10
	Nozzle orifices 1/100mm	290
	Air adjustment mm	Open

5. GENERAL DESCRIPTION

The Rotating model is characterized by an innovative baking technology which is based on an independent dual heating system (chamber gas burner and electric bedplate) and a variable speed rotating bedplate or deck.

The highly efficient baking chamber, which is made of high-quality refractory materials, combined with a smart control of the burner flame and the rotating deck, helps the oven deliver excellent performance with high levels of hourly production.



The oven should be used exclusively for baking pizzas and solid foodstuff for human consumption. It should not be used with liquid or gas products, containers or packages that have been hermetically sealed.



This type of equipment is designed for use in commercial applications, such as restaurants, cafeterias, hospitals and commercial businesses, like bakeries, butcheries, etc., but it is not designed for the continuous production of food.



As regards airborne noise emissions, the weighted sound pressure level A is lower than 70 dB(A)

6. INSTALLATION AND STORAGE

6.1 Inspections upon receipt of the equipment



Lifting and Handling Equipment Driver: the operator who has been trained to use equipments for lifting and handling materials and machines (paying special attention to the instructions provided by the manufacturer), in compliance with the applicable laws in the country where the machine is used.



For handling, loading and unloading operations, please use a pallet carrier (e.g. a forklift truck) with a minimum loading capacity of 4,000 kg and with long forks. Arrange the pallet on a surface where there's enough space for unpacking operations.

Remove the packing and make sure the content is intact.



Remove strappings.



Remove cardboard or bubblewrap casing.



Oven's metal standing support



In case of damage or missing elements or in case you see defects or damages, please do not try to repair the equipment, but instead contact our customer support center indicating the equipment's model, code and serial number (see Fig. 3.1 Sample plate).

6.2 Storage



In case the equipment is not used for a long period of time, please protect the equipment from dust and humidity. Remove the air bubble packing to allow for an adequate ventilation and to prevent the formation of condensed steam inside the oven.

7. ASSEMBLING INSTRUCTIONS

7.1 Clearances

⚠️ WARNING:  **If this oven is not properly installed a fire may result.**

To reduce the risk of fire, follow this installation instructions. A major cause of oven related fire is failure to maintain required clearances (air spaces) to combustible materials. It is of utmost importance that this oven be installed only in accordance with these instructions.

Please read this entire manual before you install the oven. Failure to follow instructions may result in property damage bodily injury or even death. Contact your local building or fire officials about restrictions and installation inspection in your area.

CLEARANCES

- I) The Univex oven must have a minimum 1" clearance to combustibles from all size and 16" from combustibles from the top.
If building a facade that will contact the oven, use completely non-combustible materials (when non-combustible building materials contact the body of the oven, the clearances to combustibles are transferred to those non combustibles). Please note that standard dry-wall (or sheet rock) is considered a combustible.
- II) Any facade above and/or 6 inches to either side of the oven doorway, must be constructed of non combustible building materials
- III) Install this oven only on non combustible floors. The non combustible floor surface should extend 40 inches out in front of the oven and extend 32 inches to either side of the oven doorway.
- IV) Leave a clearance of at least 200cm² under the oven
- V) Leave a clearance for servicing and proper operation in case you are covering the iron stand

⚠️ WARNING: installation and servicing of this product could expose you to glass wool/ceramic fibres and dust.

ALWAYS WEAR RESPIRATORY AND EYE PROTECTION WHEN INSTALLING OR SERVICING THIS APPLIANCE

7.2 Positioning of the oven



Lifting and Handling Equipment Operator: the operator who has been trained to use equipments for lifting and handling materials and machines. Handling operations should be carried out according to the instructions described in this manual and in compliance with the applicable laws in the country where the equipment is used.





The equipment should be installed in a well-ventilated place, and possibly located under a smoke extraction panel in order to ensure the complete evacuation of exhaust gases, or directly connected to the flue pipe according to the construction type. The flue outlets for combustion smoke should be sized and engineered according to the applicable provisions.

Make sure that the air inflow needed for combustion is guaranteed by a minimum surface of 5,4 ft² (oven's lower area) and with an adequate air recirculation in the upper area through a minimum aeration zone of 11 squared feet.



The oven should be positioned in such a way that it can be accessed during maintenance interventions. Once it has been positioned, please check the vent outlets. The combustion air amount for a correct combustion is 1201 ft³/h for 39 serie, 1907 ft³/h for 47 and 51 serie, while 2013 ft³/h for 55 and 59 serie. Minimum distances to be kept between the equipment and adjacent walls should not be less than 1 inch on each side.

The figures below show the assembling operations to mount the oven's standing support and then to position the oven.

	
<p>The oven's standing support is made of 4 metal tubular elements that are respectively made of two sides with four verticals, a rear part and a front part. Arrange the standing support in the desired area and assemble the various parts as illustrated.</p>	<p>Position the rear support on the sides, align the 4 holes and connect the parts with nut and bolt including the washers on both sides. Repeat the operation for the front support (n. 2 holes)</p>



Tighten firmly all the parts of the standing support.



Once the standing support has been assembled, position the structure in the area where the oven will be installed. The red panel shows the side where the oven's door will be positioned.



Load the oven's body inserting the forks as shown in the figure (see green rectangles, close to the oven's standing feet).



The incorrect positioning of the forks can severely damage the equipment.

DO NOT insert the forks in the area marked in red in the figure above.



After reaching the installation position, lift the oven up to a working height for the correct positioning on the standing support.



Align the standing support's verticals under the oven's standing feet with simple manual operations.



Lower the oven till it lays completely on the standing support's verticals.

7.3 Electrical connection



The correct functioning and the observance of safety requirements are guaranteed only if the equipment is connected to an efficient electrical system that is installed according to the applicable laws. Univex does not take any responsibility for any damage to the equipment or to third parties that is caused by the use of an electrical system that is not compliant with the applicable laws.



electrical and grounding connections must comply with the applicable portions of the national electrical code and/or other local electrical codes.

disconnect electrical power supply and place a tag at the disconnect switch to indicate you are working on the circuit.

appliances equipped with a connection box suitable for connection to a ½” conduit.



Electrical Maintenance Technician: the qualified technician who has been trained to carry out interventions on live electrical racks, branching boxes and electrical fittings, as well as to operate the equipment under normal working conditions and to make interventions on electrical systems for adjusting, maintenance, installation and repair operations.

Fig.7.1 Wiring scheme – Printed copy inside connection box

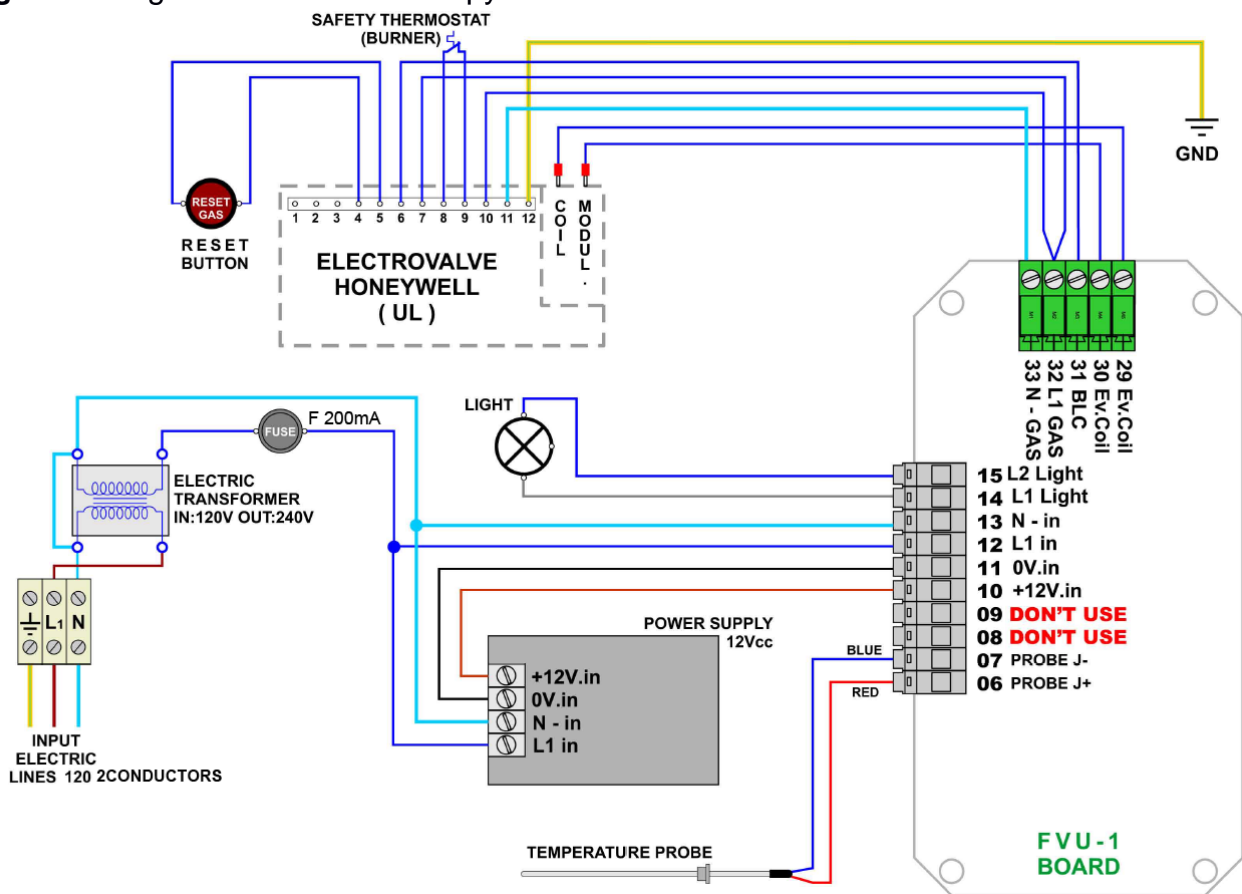

It is the electrician's responsibility to size and install the oven's supply cable to the mains system according to the oven's electrical specifications (see data on the plate).



All wiring should conform the Local codes and NEC.

The appliance must be electrically grounded in accordance with the local codes, or in absence of local codes, with the National Electrical Code NFPA 70, or the Canadian Electrical Code, CSA C22.2, as applicable.

The oven is equipped with a connection box, with terminal block inside, located on front, right side, pre-drilled to receive a 1/2" conduit.

Install the conduit and proceed driving a proper branch circuit wire in the conduit from the electrical panel to the connection box.

Loosen the upper screws of the field wire terminal.

Insert the bare wire ends in the field wire terminal openings according to the scheme (fig 7.1) and tighten the screws securely.

NOTE: Electrical diagrams are located inside the connection box, shown below

Fig 7.1.1 Connection Box Highlighted view

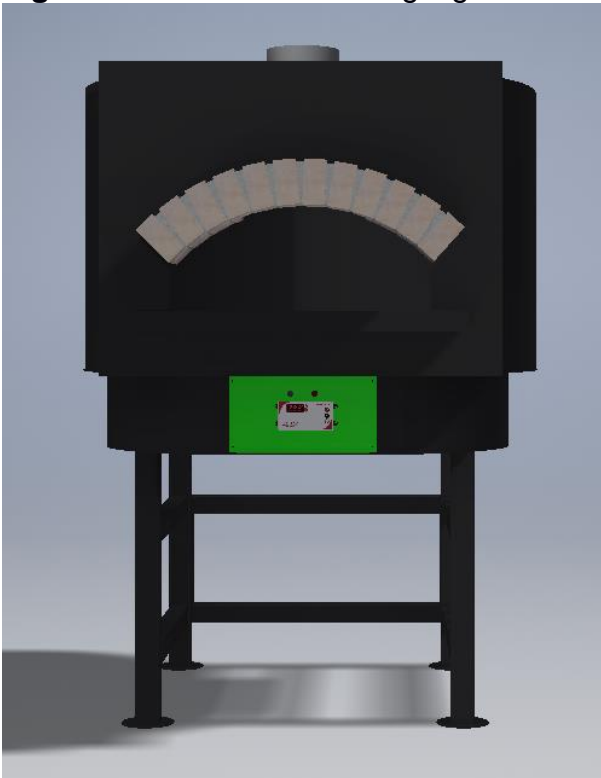

7.3.1 Electrical specifications

Voltage	120/240 2W
Frequency	50-60Hz
Amp	16

7.4 Hydraulic connection



Mechanical Maintenance Technician: the qualified technician who has been trained to operate the equipment in normal working condition and to operate on mechanical - hydraulic - pneumatic gears in order to make adjustments, maintenance interventions or repairs according to the instructions outlined in this manual.

NOTE: INSTALLATION MUST CONFORM WITH LOCAL CODES, OR IN THE ABSENCE OF LOCAL CODES, WITH THE NATIONAL FUEL GAS CODE, ANSI Z223.1/NFPA 54, OR THE NATURAL GAS AND PROPANE INSTALLATION CODE, CSA B149.1, AS APPLICABLE, INCLUDING:

1. The appliance and its individual shutoff valve must be disconnected from the gas supply piping system during any pressure testing of that system at test pressures in excess of 1/2 psi (3.5 kPa).
2. The appliance must be isolated from the gas supply piping system by closing its individual manual shutoff valve during any pressure testing of the gas supply piping system at test pressure equal to or less than 1/2 psi (3.5 kPa).

Connect the equipment to the gas distribution system with pipes and accessories to the oven's input valve (standard coupling 1/2").



Before turning on the burner:

- Check that the gas pressure entering the electrovalve is not higher than the rated value.
- Verify that the connecting tubes are tightly sealed.
- Install a gas flow stop cock near the oven for possible emergency operations and for a better regular management of the oven.
- Check the compatibility of the available fuel with the type of nozzles mounted on the burner.

The type of nozzles, the fuel and the maximum operating pressure are indicated in the plate on the oven. The flame minimum is factory adjusted. Univex accepts no responsibility for any damage caused to the equipment or to third parties as a result of an incorrect installation.

Fig 7.2 Nozzle-holder curve and damper sleeve

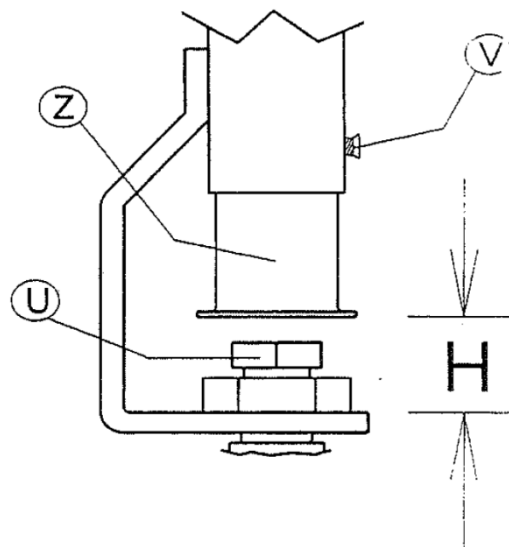

7.4.1 Gas conversions

Gas conversions from Natural Gas to LP gas or from LP gas to Natural gas must be done by a qualified installer.

Converting Gas pressure regulator

1. Turn manual shutoff valve to the "closed" position.
2. Unplug range or disconnect power.

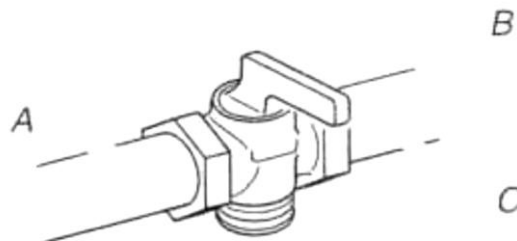

- A. To range
 B. Manual shutoff valve "closed" position
 C. Gas supply line

3. Remove the access cap by using a wrench, turning the access cap anticlockwise.
4. Remove spring retainer from the cap by pushing against the flat side of the spring retainer. Look at the spring retainer to locate the "NAT" or "LP" position.
5. Turn over the spring retainer so the "LP" is showing on the bottom.
6. Snap the spring retainer back into the cap.
7. Reinstall the cap onto the regulator.

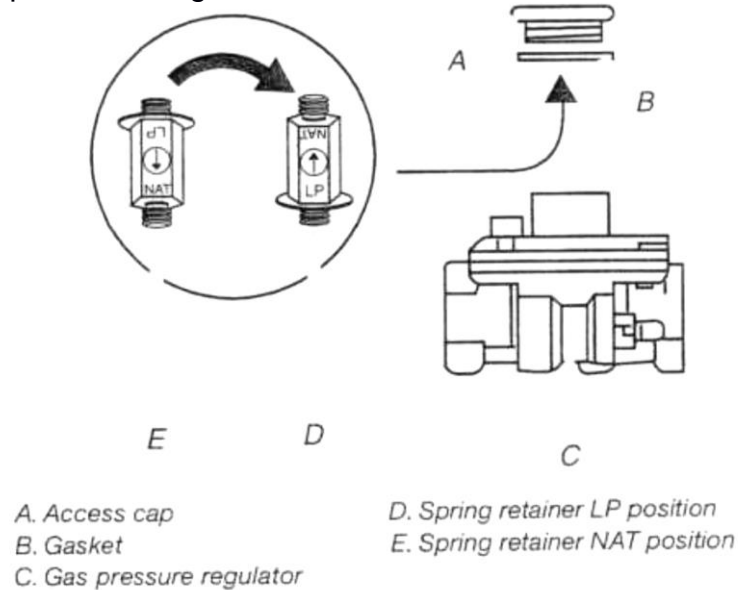

8. With a nut driver remove the gas nozzle "U" by turning it anticlockwise and lifting out. Set gas nozzle aside. Fig 7.2
9. Gas nozzles are stamped with a number on the side. The number represents the size of the orifice in mm

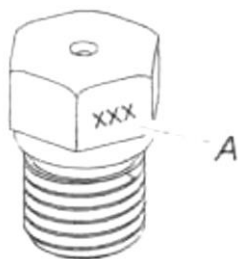

A. Stamped number

10. Place the replaced nozzle in a plastic bag for future use and keep it with literature package.
11. Loosen the V screw.
12. Shift the Z sleeve.
13. Adjust the Z sleeve to the distance H corresponding to the new installation (refer to pag.11 for regulation values) and tighten the V screw.

14. Complete installation

Setting minimum / maximum gas levels

The maximum pressure setting must first be adjusted to ensure that burner will safely light up, then the minimum pressure setting can be adjusted. Any adjustment of maximum pressure setting influences minimum pressure setting, thus a minimum pressure setting should always be re-adjusted after changing maximum value.

		Maximum	Minimum
Natural gas	iwc (kPa)	3,55 (0,88)	0,4 (0,1)
LP gas	iwc (kPa)	9,7 (2,4)	1 (0,5)

Adjusting the maximum pressure setting (see fig 7.3.)

Method 1:

- Disconnect pressure feedback connection (if applicable).
- Connect a suitable pressure gauge to pipe line or to outlet pressure tap of gas control concerned, to measure burner pressure (measuring point must be as near to burner as possible).
- Disconnect electrical connection of Moduplus®.
- Energize operator, set control in operation and wait until an outlet pressure is recorded on pressure gauge.
- Push shaft gently downwards by means of a suitable pin through the hole on the top of the Moduplus® to the bottom and hold it on.
- If maximum rate pressure needs adjustment then use an 8 mm wrench to turn adjustment screw for maximum pressure setting clockwise to increase or counterclockwise to decrease pressure, until the desired maximum outlet pressure is obtained. Release shaft.
- Check minimum pressure setting and readjust if necessary.(according instructions below) • Mount cap and reconnect pressure feedback connection (if applicable).
- If minimum and maximum pressures are set, wire the Moduplus® in circuit.
- Close pressure tap screw

Method 2:

- Disconnect pressure feedback connection (if applicable).
- Connect a suitable pressure gauge to pipe line or to outlet pressure tap of gas control concerned, to measure burner pressure (measuring point must be as near to burner as possible).
- Make sure that the appliance is in operation and the Moduplus® coil is energized with maximum current.
- If maximum rate pressure needs adjustment then use an 8 mm wrench to turn adjustment screw for maximum pressure setting clockwise to increase or counterclockwise to decrease pressure, until the desired maximum outlet pressure is obtained. • Disconnect electrical connection of Moduplus®

- Check minimum pressure setting and readjust if necessary. (according instructions below)
- Mount cap and reconnect pressure feedback connection (if applicable).
- If minimum and maximum pressures are set, wire the Moduplus® in circuit. • Close pressure tap screw

Adjusting minimum pressure setting (see fig. 7.3.)

- Disconnect pressure feedback connection (if applicable).
- Connect a suitable pressure gauge to pipe line or to outlet pressure tap of gas control concerned, to measure burner pressure (measuring point must be as near to burner as possible).
- Disconnect electrical connection of Moduplus®.
- Energize operator, set control in operation and wait until an outlet pressure is recorded on pressure gauge.
- If minimum rate pressure needs adjustment then use a 5 mm wrench to turn adjustment screw for minimum pressure setting clockwise to increase or counterclockwise to decrease pressure, until the desired minimum outlet pressure is obtained.
- Check if main burner lights easily and reliable at minimum pressure.
- Mount cap and reconnect pressure feedback connection (if applicable).
- Close pressure tap screw

Maintenance

It is recommended to check yearly the minimum and the maximum setting and readjust them if necessary.

- A Cap
- B Adjustment screw (5 mm) for minimum pressure setting
- C Adjustment screw (8 mm) for maximum pressure setting
- D 2.8 mm AMP terminals
- E Pressure feedback connection

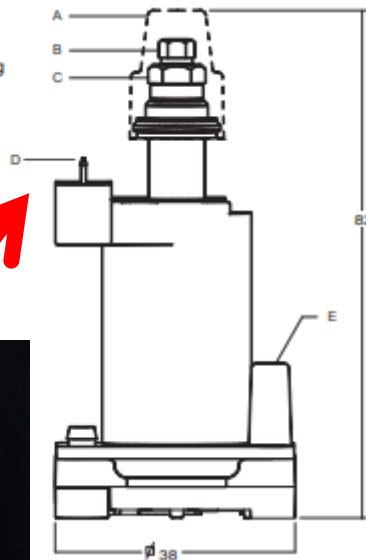

Fig 7.3

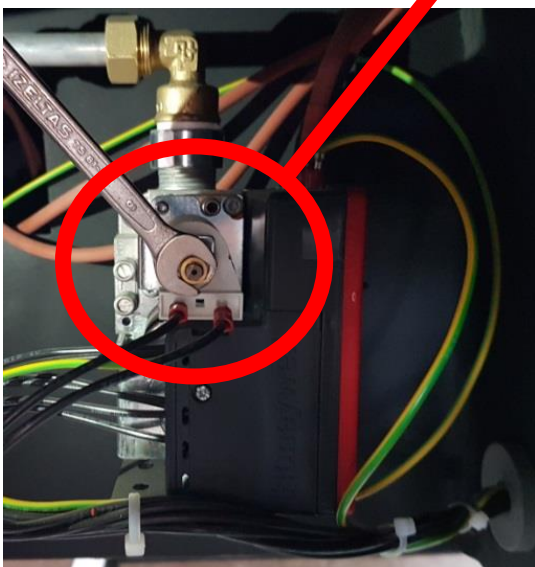

Fig 7.4
Frontal view of
the valve

8. USING THE OVEN

Once the installation has been successfully completed, the oven is ready to be operated.



CAUTION

When using the oven, please pay attention to the hot steam coming from the oven's front opening (the oven's door).

8.1 Equipment's functions and controls

8.1.1 Control panel frontal view

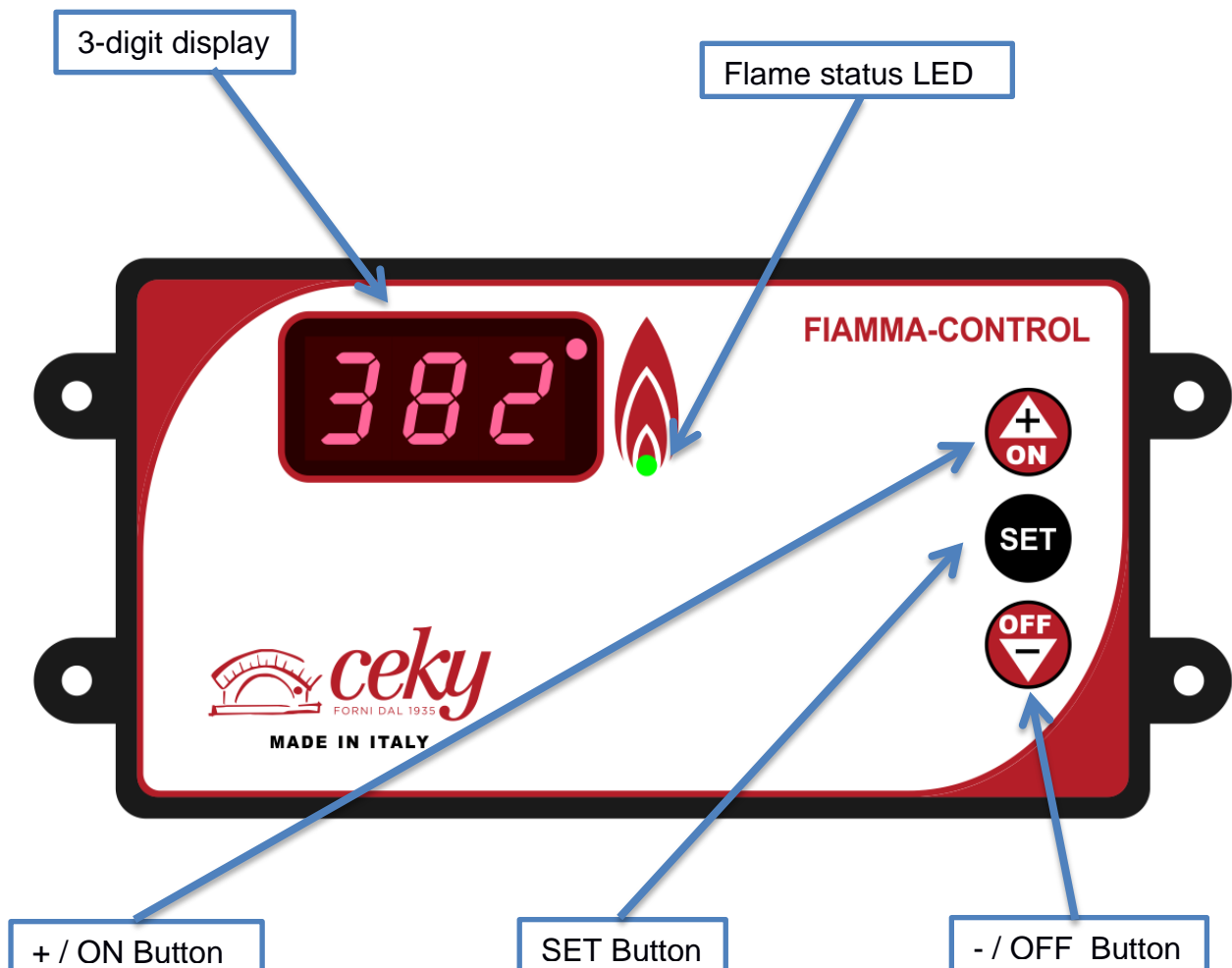

8.1.2 Turning the oven ON

When the oven is turned OFF, only 3 dots will be visible on the 3 digit display



To turn the oven ON press the +/ON Button for a short time. The firmware version will be displayed on the display (r.xx)



Finally the display will show the temperature reading for the internal chamber of the oven

8.1.3 Turning the gas burner ON and OFF

All the operations described below must be performed while the temperature reading is showing on the display



To light up the burner keep the +/ON button pressed for more than 4 seconds. The burner will start the ignition procedure and the Flame status LED will turn ON



To turn the oven off keep the -/OFF button pressed for more than 4 seconds.

8.1.4 Flame control

Pushing + and – buttons for a short time flame levels will cycle on the display in the following order: L1.0/L2.0/L3.0/L4.0/L5.0/AUt

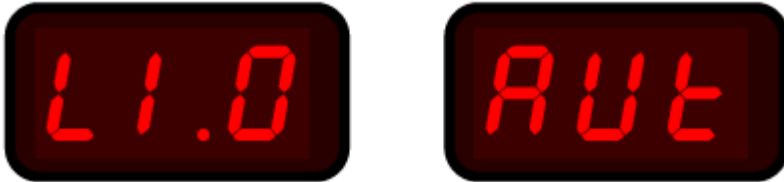

Ranging from L1.0 to L5.0 the flame height inside the oven will be increasingly higher
AUt mode is described in 8.1.7

5 seconds after the selection, if no other buttons are pushed, the display will be showing temperature reading again

8.1.5 Checking flame levels

Briefly pressing any button (+, –, SET) once will be displaying the actual flame level

5 seconds after the selection, if no other buttons are pushed, the display will be showing temperature reading again

8.1.6 Customizing flame levels L1.0 to L5.0

When regulating the flame like specified in chapter 8.1.4, if SET button is pressed within 5 seconds from the selection of numeric flame levels (NOT with AUt mode) you will access “Flame customization mode”. In this mode you will be able to fine tune the height of the flame associated to any of the 5 levels.

Upon entering “Flame customization mode” 3rd digit on the display (default = 0) will start blinking.



+ and – button will allow to increase the associated flame level modifying the value from 0 to 9. If you change the value, you can record it by pressing SET button to exit selection immediately, or wait 5 seconds: new value will be saved in any case.



8.1.7 Setting AUt Levels

When selecting flame levels like described in 8.1.4 if SET button is pushed within 5 seconds after AUt is shown on the display, you can access the temperature regulation mode.



All 3 digits on the display will be blinking and you will be able to set desired temperature using – or + button to increase or decrease the displayed value. Keeping – or + buttons pushed for a longer time will speed up the selection cycling faster between values.



If you change the value, you can record it by pressing SET button to exit selection immediately, or wait 5 seconds: new value will be saved in any case.

8.1.8 Burner Safety Block

Whenever burner faces a forced shutdown due to flame not being correctly detected by the safety probe (i.e. gas not reaching the oven) the burner will be blocked and will need to be manually rearmed. This status will be indicated on the display by alternating “bLc” and “rSt” codes, in order to suggest the operator to proceed with the reset and rearm procedure.



To reset the error keep the red reset button pressed for 2 seconds and wait for the display to go back to its standard working procedure. If the problem causing the block is solved (i.e. opening a gas knob that was accidentally closed) the oven will be back to its normal functionality. If the problem still persists the burner will block again, reporting that the issue was not solved.

8.1.9 Anomalies

Any problem related to the thermocouple will display EEE error on the panel. This could mean that the thermocouple is damaged, disconnected or in any way unable to give a correct temperature reading.



Should the oven exceed his maximum temperature range, the error HHH will be displayed on the console. Turn off the burner and let the oven rest for some time, until it gets back to its normal operational temperature range.



8.1.10 Display units

Temperature reading can be displayed either in C° or F°. To switch from a unit to the other press SET button for 3 seconds while the oven is turned off and in standby (3 dots visible on the display).



After 3 seconds the actually set unit will be displayed, it is possible to cycle through units using + or – button. Last selection will be automatically stored.



Whenever the display unit is changed, the previously recorded AUt temperature value will be reset to its default value (482F° or 250C°). A new set procedure like described in chapter 8.1.7 will be necessary to record the desired value again.

9. MAINTENANCE



During the operation and even after a long time after turning the oven off, the cooking chamber will remain HOT. Consider this while planning any maintenance inside the oven.

The operations described in the following paragraph should always be carried out with the equipment turned off (equipment disconnecter set to OFF).



The user should regularly clean the equipment's external covering using a soft cloth moistened with neutral and non-aggressive detergents, and then wipe off with a dry cloth.

9.1 Daily maintenance



First Level Operator: the operator, with no specific skills, who is able to use the equipment in normal working condition and for simple maintenance interventions.

Remove any residue from the oven floor using a vacuum cleaner, a broom, a soft bristle brush or similar tools. Conduct the operation when **the oven is turned off** and with no flame inside the baking chamber. Any residue can be removed from the frontal door.



Do not use water or detergents to clean the oven's baking deck or any internal part of the oven.

9.2 Periodic maintenance

Recommended time interval: once every 2 years



Manufacturer's Technician: the qualified technician who has been designated by the manufacturer to carry out complex operations in specific situations or, in any case, on the basis of what has been agreed upon with the user. Depending on each case, the personnel is requested to have mechanical and/or electrical and/or electronic and/or IT skills.

Type of intervention: Cleaning and maintenance of the gas burner, combustion adjustment and control.

Recommended time interval: once every 10 years



Manufacturer's Technician: the qualified technician who has been designated by the manufacturer to carry out complex operations in specific situations or, in any case, on the basis of what has been agreed upon with the user. Depending on each case, the personnel is requested to have mechanical and/or electrical and/or electronic and/or IT skills.

Type of intervention: Inspection and adjustment of the baking deck and internal dome.

10. TROUBLESHOOTING

- ***bLc / rSt messages displayed:*** Burner needs a manual reset. In order to reset, press and hold the red button above to the console **for 2 seconds**, then release it. The displayed error will disappear and you can try again to start it up. This problem is caused by detection probe failing flame check during normal operation or ignition process. The problem is often cause by gas supply being closed during ignition operation; if that is the cause, open the gas knob, reset the error with the procedure described above, and turn the oven on again.
- ***HHH message on display:*** Max temperature has been exceeded
- ***EEE blinking message on display:*** Thermocouple reading problem, verify connection or call assistance for help.
- ***Gas flame is low even at maximum level:*** check that inlet pressure is set according to the requested value and that the correct nozzle for your type of gas is installed. Also verify max/min valve regulation according to the procedures described in this manual.
- ***Irregular gas flame:*** check that the installed nozzle is the correct one for the gas type you are using. Also regulate max/min values according to the nominal values stated in the manual.
- ***I have problems reaching higher temperatures:*** verify that the extraction system is correctly set for you type of gas. If the extraction is too strong the oven might face problems reaching the higher temperatures.



If the suggested operation did not solve the malfunctioning, interrupt the operation and ask for help to the customer support center.



Do not open the equipment's external covering if you're not expressly authorized in writing by Univex or any of his authorized maintenance services. The non-observance to this rule will lead to the immediate invalidation of the warranty and of the retailer's ensuing responsibilities for aspects concerning safety and functioning.



Gas burning pizza brickoven

11. INTERVENTION REQUEST FORM - REPLACEMENT PARTS

Dear:

Univex Corporation
603-893-6191
service@univexcorp.com

Date _____.

REPLACEMENT PART ORDERING - FAULT REPORTING - INFORMATION FORM

Client:	Model
Location	Code
Address	Serial n.
Telephone	
Fax:	Sent by

Replacement part ordering table:

Product code	Qty	Notes

APPLICANT'S STAMP AND SIGNATURE

Technician visit requested for the following faults:
Fault notes or description



Gas burning pizza brickoven

12. REPLACEMENT PART LIST

Product description	Product code
Ceky Fiamma control panel	YPNLSTU
Oven lamp (internal led only)	YCBLAMP
Lamp bloc (lamp, lamp-holder, Pirex glass, metal lamp-holder and wiring)	YLIGHT
Flame detection electrode	ZELETRIV
Startup electrode	ZELETACC
Gas valve, including gas modulator	ZVK410
Gas valve safety and control module	ZS456
Reset button	ZPLSLUM
Detection Probe Connector Cable	ZCVELET62R2
Sparkler Connector Cable	ZCVELET66
13.7 inches thermocouple - M8 Connector	ZTRME
39.4 inches Thermocouple connection blue cable M8 connector	ZCVTRM100

13. ATTACHMENT LIST

This manual also includes the following documents:

Type of document	Code
Electrical wiring scheme	Brickoven_wiring_scheme.pdf



Gas burning pizza brickoven

14. WARRANTY

CONDITIONS AND RESTRICTIONS:

Univex guarantees the product for a period of **12 months**.

The warranty becomes effective as per the purchase date indicated on the invoice when the equipment is delivered.

Univex agrees to repair or replace without charge all parts within the warranty period if they fail due to a manufacturing defect. The warranty does not include any form of compensation resulting from direct or indirect damages to persons or things.

As long as the warranty is effective, if the Client desires that the repair should be carried out by Univex technicians, they should send a written request to Univex. In this case, they will also take charge of all the costs associated with travel, board and lodging.

For interventions due to defects or faults that are not clearly linked to materials or manufacturing, all costs deriving from travels, repair and/or replacement of all parts will be charged to the buyer.

The warranty cannot be extended after a repair intervention is carried out on the equipment.

In case parts of the equipment are returned, the Client can make the shipment only after receiving the written authorization from Univex. Costs of packing and shipping are charged to the client (unless the parties agree otherwise).

In any case, the warranty does not cover accidental damages resulting from transportation, negligence, inappropriate use, non-compliance with the instructions described in this manual, and from any event that does not depend on the normal operation or use of the equipment.

The warranty expires if the equipment is repaired by non-authorized third parties or if you use tools or accessories that are not provided, recommended or approved by Univex, or in case the registration number is removed or altered during the warranty period.

The warranty ceases immediately to be effective upon default or delay in payment.

Univex declines any responsibility for any damages to persons or things resulting from the wrong or inappropriate use of the equipment.

For any controversy, the court of Brescia (ITALY) will be the exclusive competent court.