

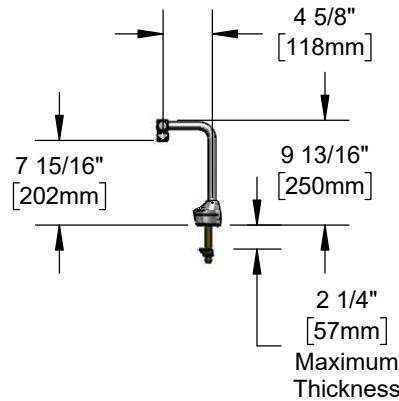

Architect/Engineering Specifications:

8" high single hole deck mount electronic sensor glass filler with polished chrome plated brass body and 4 5/8" high arc rigid nozzle, 1.5 GPM vandal resistant laminar device with anti-microbial coating, AC/DC control module with internal flow control setting switches, and water filtration kit with 20" flexible supply hose with 3/8" compression connection. Certified to ASME A112.18.1/CSA B125.1, NSF 61-Section 9, NSF 372 and UL 1951. Meets ADA ANSI/ICC A117.1 requirements.

Job Name _____
 Model Specified _____ Quantity _____
 Variations Specified _____
 Date _____

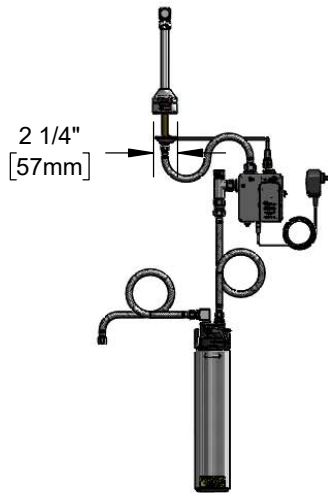

Features & Benefits:

- 8" high single hole deck mount glass filler w/ polished chrome plated brass body
- 4 5/8" high arc rigid nozzle
- 1.5 GPM vandal resistant laminar device with anti-microbial coating, Series 6 (B-0199-06-LF15A)
- Water resistant control module w/ internal flow control switches for adjusting auto time out & shut off delay settings
- Optional auto flush feature flows water for 30 seconds after every 12 inactive hours
- Plug in AC transformer or (4) AA battery (DC) power options
- Low battery LED indicator light
- Water filtration kit
- 20" flexible supply hose w/ 3/8" compression connection
- Material: Polished chrome plated brass body & tubular spout

Product Compliance:

- ASME A112.18.1 / CSA B125.1
- NSF 61 - Section 9
- NSF 372 (Low Lead Content)
- ANSI A117.1 (ADA)
- UL 1951

Warranty: Three Year (Limited)

Performance Data:

- Pressure: 20 - 125 psi [1.38 - 8.62 bar]
- Temperature: 40 °F - 140 °F [4.44 °C - 60 °C]
- Flow Rate: 1.5 GPM [5.7 L/min] @ 60 psi [4.14 bar]
- Water Consumption: @10 sec=.25 gal [.95 L/min]
@15 sec=.38 gal [1.42 L/min]



ADA Compliant



Optional Outlets (Series 1 / VR Series 6)

GPM	Aerated	Non-Aerated (Laminar)	VR Aerated	VR Non-Aerated (VR Laminar)	Optional Deck Plates
0.35	N/A	<input type="checkbox"/> B-0199-01-N035	N/A	<input type="checkbox"/> B-0199-06-N035	<input type="checkbox"/> 4" Chrome Plated Brass Deck Plate
0.5	N/A	<input type="checkbox"/> B-0199-01-N05	N/A	<input type="checkbox"/> B-0199-06-N05	<input type="checkbox"/> 8" Chrome Plated Brass Deck Plate
1.0	<input type="checkbox"/> B-0199-01-F10	N/A	<input type="checkbox"/> B-0199-06-F10	N/A	
1.5	<input type="checkbox"/> B-0199-01-WS	<input type="checkbox"/> B-0199-29	<input type="checkbox"/> B-0199-06-WS	<input type="checkbox"/> B-0199-29VR	
2.2	<input type="checkbox"/> B-0199-01	<input type="checkbox"/> B-0199-21	<input type="checkbox"/> B-0199-06	<input type="checkbox"/> B-0199-21-VRF	

