



22402

ERA / EBD ELECTRIC FRYER

See GENERAL section for a complete listing of Models and ML Numbers.

1ER50-Series
1ER85-Series
2ER50-Series
2ER85-Series
2XER50-Series
2XER85-Series
3ER50-Series
3E85-Series
3ER85-Series
4E50-Series
4ER50-Series
4E85-Series
4ER-Series

- NOTICE -

This Manual is prepared for the use of trained Hobart Service Technicians and should not be used by those not properly qualified.

This manual is not intended to be all encompassing. If you have not attended a Hobart Service School for this product, you should read, in its entirety, the repair procedure you wish to perform to determine if you have the necessary tools, instruments and skills required to perform the procedure. Procedures for which you do not have the necessary tools, instruments and skills should be performed by a trained Hobart Service Technician.

The reproduction, transfer, sale or other use of this manual, without the express written consent of Hobart, is prohibited.

This manual has been provided to you by ITW Food Equipment Group LLC ("ITW FEG") without charge and remains the property of ITW FEG, and by accepting this manual you agree that you will return it to ITW FEG promptly upon its request for such return at any time in the future.

TABLE OF CONTENTS

Service Updates	3
TIS DOCUMENT LIST - ERA/EBD ELECTRIC FRYER	3
SERVICE UPDATES	3
GENERAL	4
INTRODUCTION	4
SINGLE FLOOR MODEL FRYERS	4
KLEENSCREEN FILTRATION SYSTEM	4
SPECIFICATIONS	4
TOOLS	5
MODELS AND ML NUMBERS	5
REMOVAL AND REPLACEMENT OF PARTS	7
COVERS AND PANELS	7
COOKING CONTROLS	8
DISCARD VALVE SWITCH (KLEENSCREEN FRYERS ONLY)	8
TEMPERATURE PROBE	9
HIGH LIMIT THERMOSTAT	9
ELECTRICAL COMPONENTS	10
CIRCUIT BREAKER / SUPPLY BOX COMPONENTS	10
FILL SOLENOID VALVE (KLEENSCREEN FRYERS ONLY)	11
HEATING ELEMENTS	11
LIFT ASSIST SPRINGS	12
TILT SWITCH	13
PUMP AND MOTOR (KLEENSCREEN FRYERS ONLY)	14
SERVICE PROCEDURES AND ADJUSTMENTS	15
TEMPERATURE PROBE TEST	15
COOKING CONTROL CALIBRATION	15
LIFT ASSIST SPRING ADJUSTMENT	16
HEATING ELEMENT TEST	17
ELECTRICAL OPERATION	18
COMPONENT FUNCTION	18
COMPONENT LOCATION	19
SEQUENCE OF OPERATION	20
SCHEMATIC DIAGRAMS	23
WIRING DIAGRAMS	24
TROUBLESHOOTING	47
ALL MODELS	47
FRYMATE (DUMP STATION) WITH OPTIONAL HEATER	47
KLEENSCREEN FILTERING SYSTEM	48

Service Updates

TIS DOCUMENT LIST - ERA/EBD ELECTRIC FRYER

SERVICE TAB	
Document Title	Document Type
ERA/EBD Service Manual	Service Manual
DVI SWITCH MALFUNCTION ON FRYERS WITH OR WITHOUT KLEENSCREEN PLUS FILTERING SYSTEMS	Technical Service Instructions (TSI)

SERVICE TAB (Multimedia)	
Document Title	Document Type
Repair Flood-Damaged Equipment	Misc
ERD & ERC Series Electric Fryers With Kleenscreen Plus Filtration Systems (05/15)	Operator
Fryer Computer Control Guide	Operator
Fryer Computer Control Guide	Service Instructions
Hobart Gas & Electric Fryers Computer Controller Kits Part No. 913012-1 & 913012-4	Service Instructions
ER Series Electric Fryers With Tridelta Controls	Service Manual
ERA & EBD Series Electric Fryers With Kleenscreen Plus Filtration Systems	Service Manual
Rating Plate Locations on Current Vulcan-Hart/Wolf Range Equipment	TSB
SB900 GR/ER Series Fryers Filtering System Oil Return Line Solenoid Valve Leak	TSB
TSB 1037A Hobart to Vulcan "Common" Model Cross Reference List	TSB
HG/HF & GR/ER Series Filtering System Fryer Batteries with Solid State (D Series) or Computer Controls (Series) - Oil Return Line Solenoid Valve Leak	TSI

PARTS TAB	
Document Title	Document Type
ER Series Parts Catalog	Parts Catalog

DIAGRAMS TAB	
Document Title	Document Type
HGC5, DGC5, VC4G, WKGD Series	Wiring Diagram

SERVICE UPDATES

- Added 15 diagrams to WIRING DIAGRAMS section.

December 2020

GENERAL

INTRODUCTION

This Service Manual covers specific service information related to the models listed on the front cover. ERA and EBD series electric fryers come equipped with behind-the-door solid state controls. The features and operation of the cooking controls are the same for both single floor model fryers and Kleenscreen battery fryers. All pictures and illustrations are of a 2ER50AF (17kW, 208V) unless otherwise noted.

SINGLE FLOOR MODEL FRYERS

Fryers with the Filter-Ready option installed, use the Mobile Filter. For service information related to the Mobile filter refer to F24599 MOBILE FILTERS. A GRO Frymate (dump station) can be configured in a battery with fryers 15½ inches or 21 inches in width.

Model	KILOWATT EACH FRY TANK	FRYER WIDTH (INCHES) TOTAL SYSTEM	SHORTENING CAPACITY (LBS) EACH FRY TANK
1ER50A (1E50BD)	17	15.5	50
1ER50AF (1E50BDF)	17	15.5	50
1ER85A (1E85BD)	24	21.0	85
1ER85AF (1E65BDF)	24	21.0	85
2ER50AF (2E50BDF)	17	31.0	50
2ER85AF (2E85BDF)	24	42.0	85
2XER50AF (2XE50BDF)	17	31.0	50
2XER85AF (2E85BDF)	24	42.0	85
3ER50AF (3E50BDF)	17	46.5	50
3ER85AF (3E85BDF)	24	63.0	85
4ER50AF (4E50BDF)	17	62.0	50
4ER85AF 4E85BDF)	24	84.0	85

KLEENSCREEN FILTRATION SYSTEM

The Kleenscreen filtration system is integrated into the ERA & EBD Series fryer battery. The filter is housed in a pull-out drawer assembly at the base of the fryer. The filtering components in the drawer include a stainless steel filter tank, crumb-catch basket and a dual element mesh filter screen. With the filter drawer closed, a self-seating oil return line provides the path to return the filtered shortening to the fry tank.

This system is designed to provide a thorough and easy method to filter the shortening.

Some of the benefits include:

- Self-contained system eliminating the use of external filter equipment.
- Paperless filtering system.

- Easy to clean and low maintenance.

Kleenscreen fryer batteries are available in a minimum of two and a maximum of four fryer sections. The fryer size of each section is identical.

A GRO Frymate (dump station) can also be included as one or more of the sections.

SPECIFICATIONS

MODEL	KW PER FRYER SECTION	AMPS - EACH FRYER SECTION (3 PHASE/ 60HZ)*		
		PER LINE		
		208V	240V	480V
ALL 50 LB CAPACITY FRYERS	14	39	34	17
	17	47	41	20

MODEL	KW PER FRYER SECTION	AMPS - EACH FRYER SECTION (3 PHASE/ 60HZ)*		
		PER LINE		
		208V	240V	480V
ALL 85 LB CAPACITY FRYERS	24	67	58	29
NOTES:	* Amperage values in the table are nominal. Tolerance is +5/-10%.			

Single Floor Model Fryers

- 208VAC, 240VAC or 480VAC (3 phase, 60HZ) to power the heating elements.

Drawer Filter System

Separate electrical connections are required for each section of the battery.

- 208VAC, 240VAC or 480VAC (3 phase, 60HZ) to power the heating elements.
- On 208VAC and 240VAC models, a transformer provides power for the fryer controls and drawer filter system controls.
- On 480VAC models, a 120VAC connection is required for each fryer section.

TOOLS

Standard

- Standard set of hand tools.
- VOM with minimum of NFPA-70E CATIII 600V, UL/CSA/TUV listed. Sensitivity of at least 20,000 ohms per volt and the ability to measure DC micro amps. Meter leads must also be rated at CAT III 600V.
- Digital temperature tester (thermocouple type).

Special

- Electrostatic Discharge Kit.
- Burndy pin extraction tool RX2025 GE1; Newark Electronics Catalog Number 16F6666. Used for removing pin terminals on Burndy connectors.
- Clamp on type amp meter with minimum of NFPA-70E CAT III 600V,UL/CSA/TUV listed.

MODELS AND ML NUMBERS

The following table contains a complete listing of fryer models addressed by this Service Manual.

Model	ML Number
1ER50A	ML-136730
1E50BD	
1ER50AF	ML-136799
1E50BDF	
1ER85A	ML-136740
1E85BD	
1ER85AF	ML-136802
1E85BDF	
2ER50AF	ML-136741
2E50BDF	
2ER85AF	ML-136742
2E85BDF	
2XER50AF	ML-136747
2XE50BDF	
3ER50AF	ML-136743
3E50BDF	
3ER85AF	ML-136744
3E85BDF	

Model	ML Number
4ER50AF	ML-136745
4E50BDF	
4ER85AF	ML-136746
4E85BDF	

REMOVAL AND REPLACEMENT OF PARTS

COVERS AND PANELS



WARNING

Disconnect the electrical power to the machine and follow lockout / tagout procedures. There may be multiple circuits. Be sure all circuits are disconnected.

Electrical Components Access Panel

1. Remove screws at top of access panel and lower panel.



2. Lift from hinge then remove panel.
3. Reverse procedure to install.

Element Head Cover

1. Drain shortening from fry tank.
2. Remove screws from rear of element head assembly.

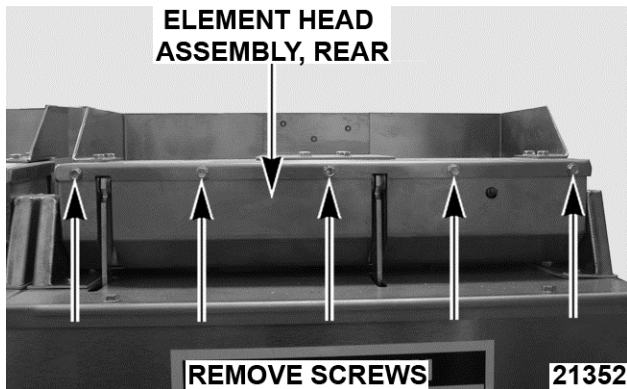

3. Raise heating elements and place 2x4 lumber under them for support.

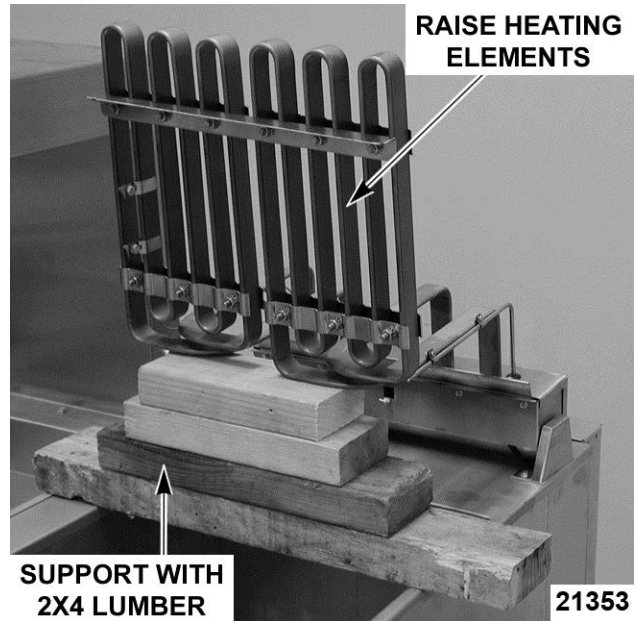

4. Remove screws from the bottom of element head assembly.

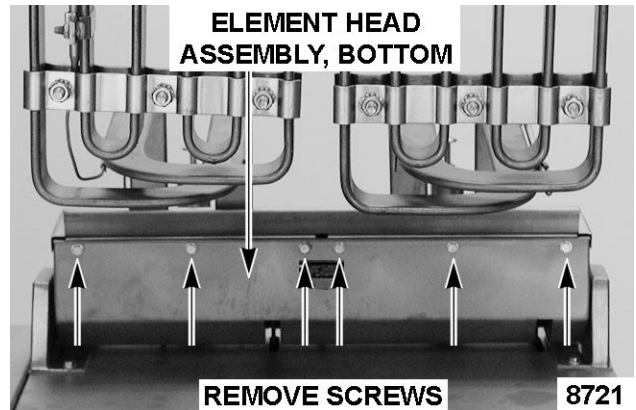

NOTE: Head cover will separate from element head base. Heating elements remain attached to element head cover.

5. Grasp heating elements and remove 2x4 lumber. Lift the elements and pull toward rear of fryer.
6. Lower the heating elements and place them in fry tank.
7. Reverse procedure to install.

COOKING CONTROLS



⚠ WARNING

Disconnect the electrical power to the machine and follow lockout / tagout procedures. There may be multiple circuits. Be sure all circuits are disconnected.

NOTICE

Certain components in this system are subject to damage by electrostatic discharge (ESD) during field repairs. An ESD kit is required to prevent damage. The ESD kit must be used anytime the circuit board is handled.

1. Open fryer section door(s).
2. Remove electrical connection to cooking controls.

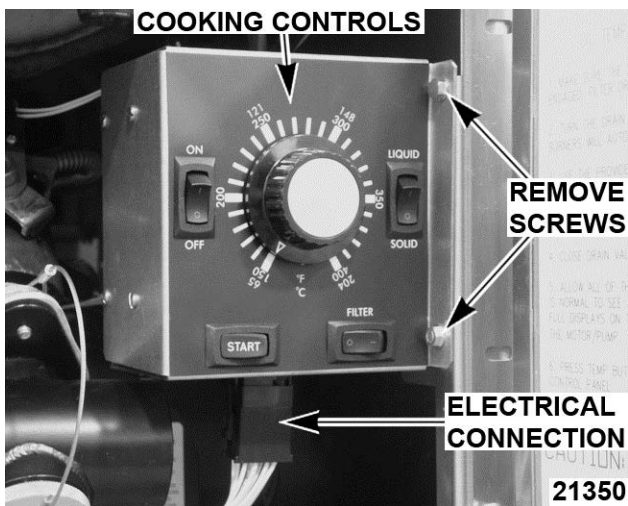

3. Remove screws securing controls.
4. Remove cooking control cover.
5. Disconnect lead wires from the component being replaced then remove from control box.

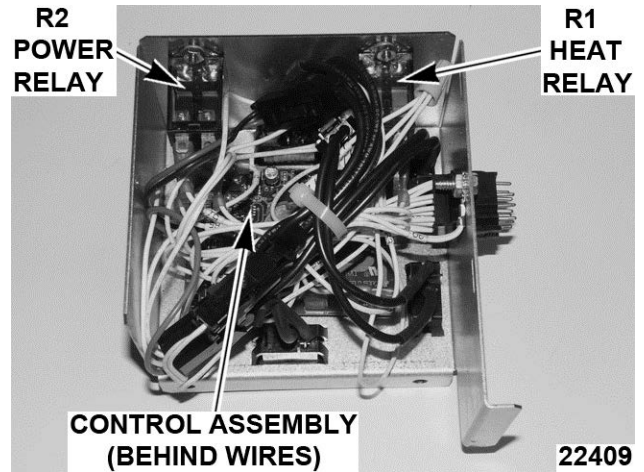

6. Reverse procedure to install and check for proper operation.

DISCARD VALVE SWITCH (KLEENSCREEN FRYERS ONLY)



⚠ WARNING

Disconnect the electrical power to the machine and follow lockout / tagout procedures. There may be multiple circuits. Be sure all circuits are disconnected.

NOTE: Switches are not adjustable.

1. Open the door to the fryer section being serviced.
2. Disconnect lead wire connector.
3. Remove switch mounting screws.

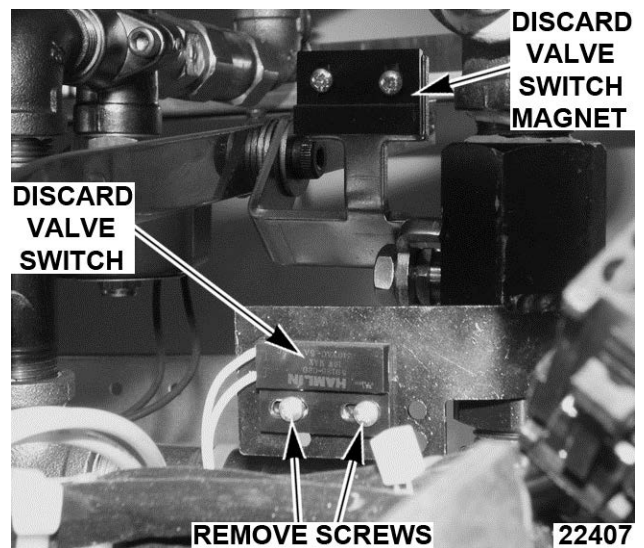

4. Remove discard valve switch.

- Reverse procedure to install and check for proper operation.

TEMPERATURE PROBE



⚠ WARNING

Disconnect the electrical power to the machine and follow lockout / tagout procedures. There may be multiple circuits. Be sure all circuits are disconnected.

CAUTION

Do not sharply bend and kink, or clamp down on the capillary tube or damage may occur.

- Raise heating elements.
- Remove clamps from temperature probe.

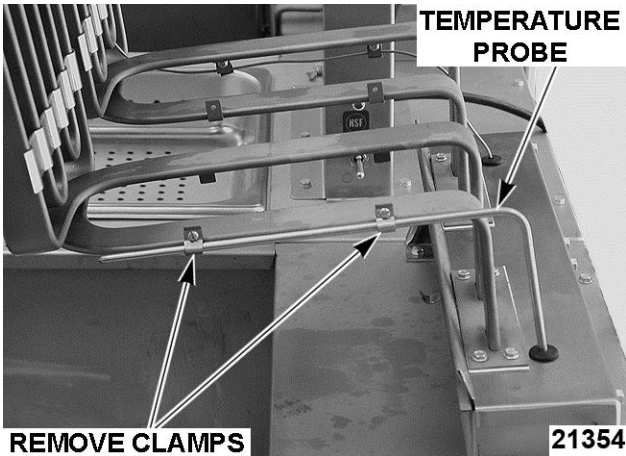

- Remove element head cover as outlined under COVERS AND PANELS.
- Disconnect temperature probe lead wires.

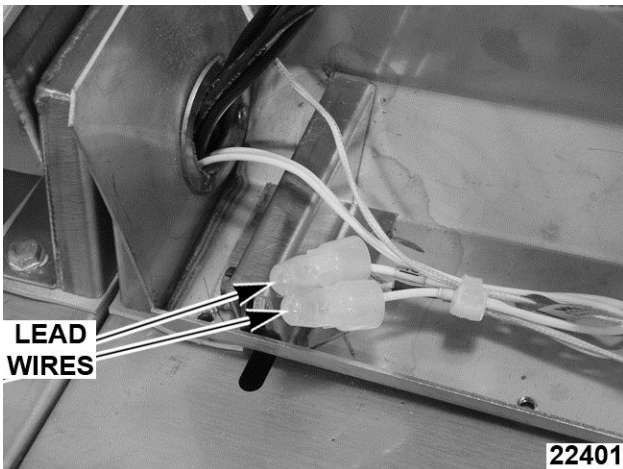

- Remove temperature probe from the element head.
- Reverse procedure to install.

NOTE: When installing, ensure grommet remains in place when inserting temperature probe thru the grommet in the element head.

- Check cooking control calibration as outlined in COOKING CONTROL CALIBRATION.

HIGH LIMIT THERMOSTAT



⚠ WARNING

Disconnect the electrical power to the machine and follow lockout / tagout procedures. There may be multiple circuits. Be sure all circuits are disconnected.

CAUTION

Do not sharply bend and kink, or clamp down on the capillary tube or damage may occur.

- Raise heating elements.
- Loosen clamps securing capillary tube and bulb to element.

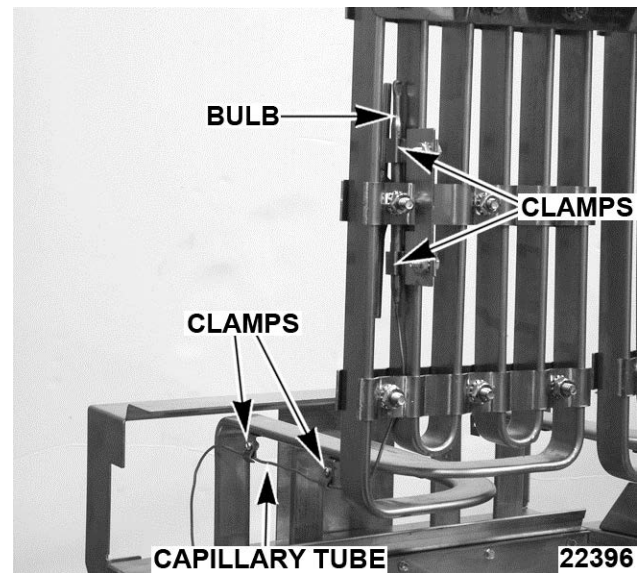

- Remove element head cover as outlined under COVERS AND PANELS.
- Remove high limit from mounting bracket.

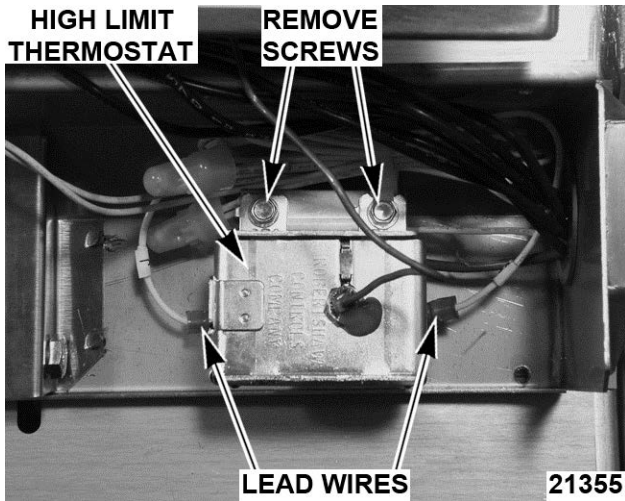

5. Disconnect high limit lead wires.
6. Remove grommet from the element head assembly.
7. Remove the bulb, capillary tube and high limit from the element head assembly.
8. Reverse procedure to install.
 - A. Slide grommet onto capillary tube then insert grommet into the capillary tube thru hole in the element head.
 - B. Move element lead wires clear of high limit when installing.

ELECTRICAL COMPONENTS



⚠ WARNING

Disconnect the electrical power to the machine and follow lockout / tagout procedures. There may be multiple circuits. Be sure all circuits are disconnected.

CAUTION

Components in this system are subject to damage by electrostatic discharge. A field grounding kit is available to prevent damage. The field service kit must be used anytime the control board is handled.

1. Open electrical component access panel.



2. Disconnect lead wires then remove the component being replaced.

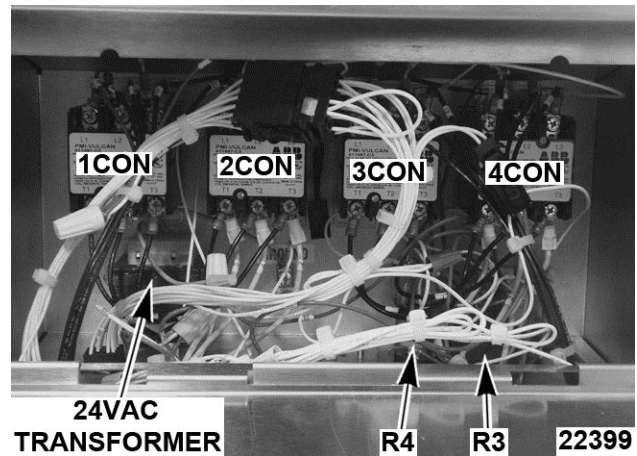

3. Reverse procedure to install the replacement component and check for proper operation.

CIRCUIT BREAKER / SUPPLY BOX COMPONENTS



⚠ WARNING

Disconnect the electrical power to the machine and follow lockout / tagout procedures. There may be multiple circuits. Be sure all circuits are disconnected.

CAUTION

Components in this system are subject to damage by electrostatic discharge. A field grounding kit is available to prevent damage. The field service kit must be used anytime the control board is handled.

NOTE: Supply box will contain a circuit breaker on 24kW 208-240V units.

1. Remove screw and circuit breaker/ supply box cover.

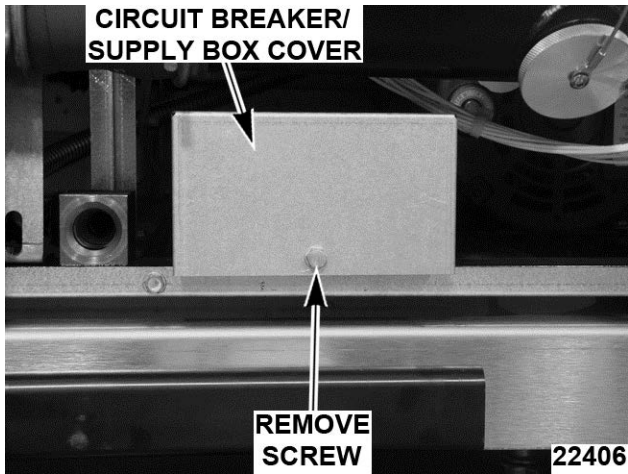

2. Disconnect lead wires then remove the component being replaced.

NOTE: Supply box will contain a circuit breaker on 24kW 208-240V units.

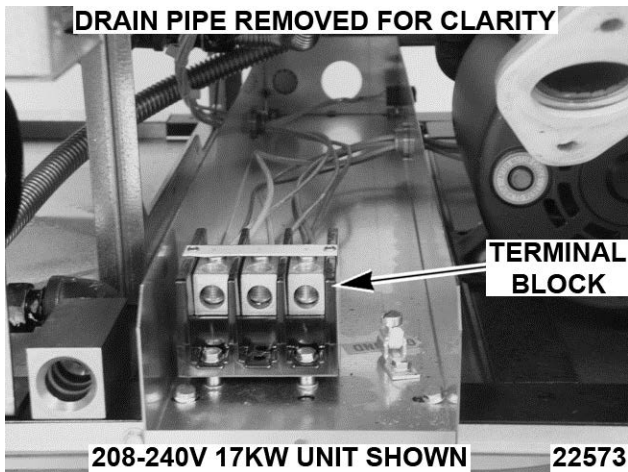

3. Reverse procedure to install the replacement component and check for proper operation.

FILL SOLENOID VALVE (KLEENSCREEN FRYERS ONLY)



⚠ WARNING

Disconnect the electrical power to the machine and follow lockout / tagout procedures. There may be multiple circuits. Be sure all circuits are disconnected.

1. Disconnect swivel pipe fitting at rear of fry tank.

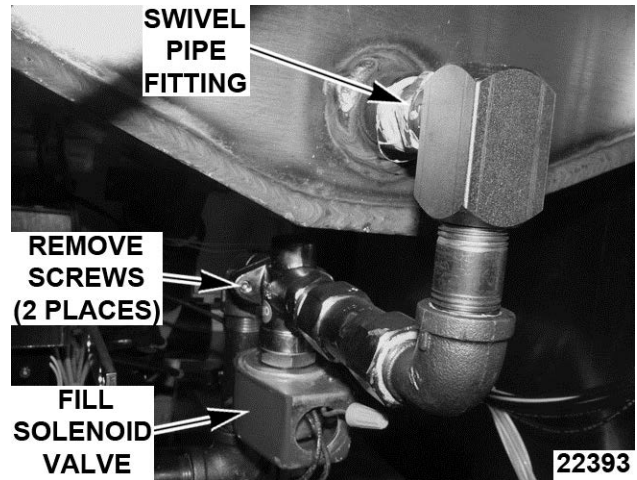

2. Disconnect fill solenoid valve lead wire connector from below control panel.
3. Remove screws (2) securing the solenoid valve body flange to pipe tee then remove the assembly from fryer.
4. Remove pipe fittings from solenoid valve and install on replacement valve.
5. Reverse procedure to install and check for proper operation.

HEATING ELEMENTS



⚠ WARNING

Disconnect the electrical power to the machine and follow lockout / tagout procedures. There may be multiple circuits. Be sure all circuits are disconnected.

CAUTION

Components in this system are subject to damage by electrostatic discharge. A field grounding kit is available to prevent damage. The field service kit must be used anytime the control board is handled.

1. Raise heating elements.
 - A. If replacing left heating element, loosen high limit bulb and capillary tube clamps. Remove high limit bulb and capillary tube from clamps then position away from element.
 - B. If replacing right heating element, remove temperature probe clamps and position temperature probe away from element.

NOTE: When installing high limit, route the capillary tube and center the bulb between the clamps before tightening.

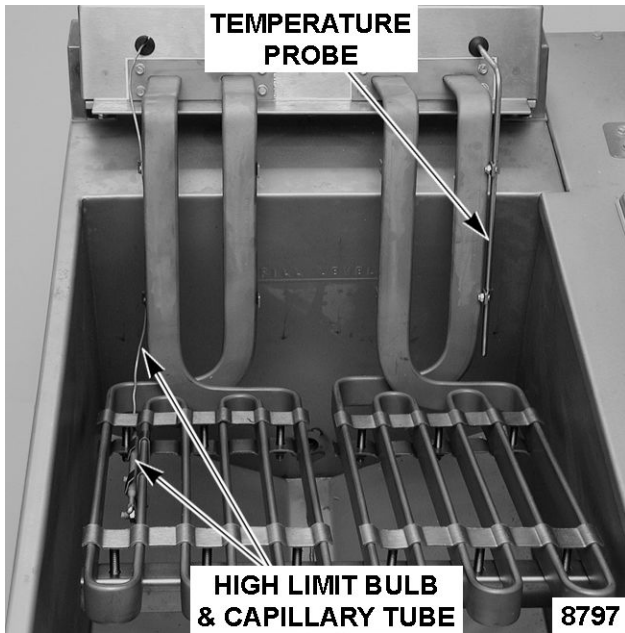

2. Remove element assembly clamps.

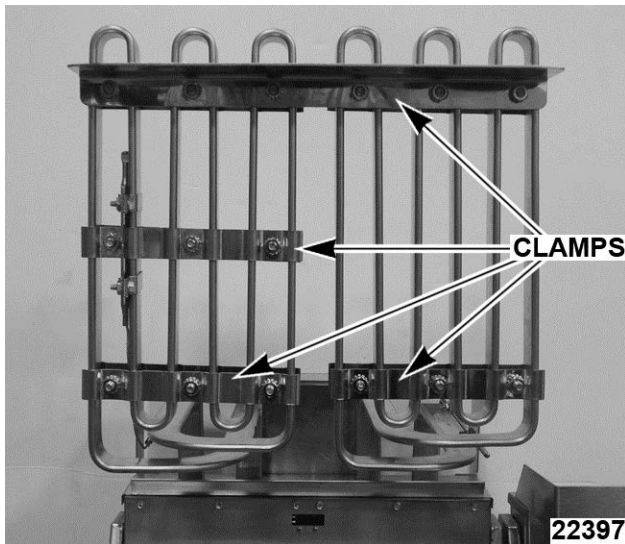

3. Remove element head cover as outlined under COVERS AND PANELS.
4. Disconnect heating element lead wires.

NOTE: Each heating element assembly contains three individual elements (six lead wire connections total).

5. Remove screws from heating element mounting bracket and remove heating element.

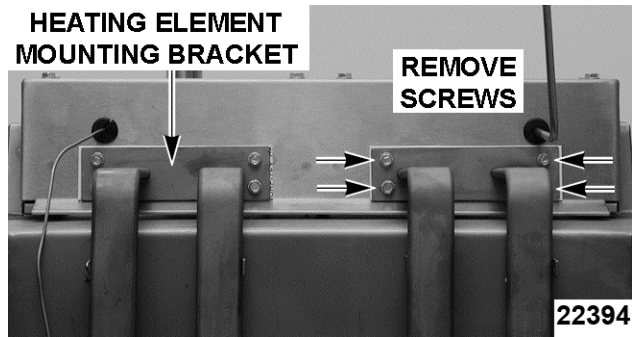

6. Reverse procedure to install.

LIFT ASSIST SPRINGS



⚠ WARNING

Disconnect the electrical power to the machine and follow lockout / tagout procedures. There may be multiple circuits. Be sure all circuits are disconnected.

NOTE: If one spring breaks, replace both springs.

1. Raise heating elements and place 2x4 lumber under them for support. Heating elements are to remain upright.

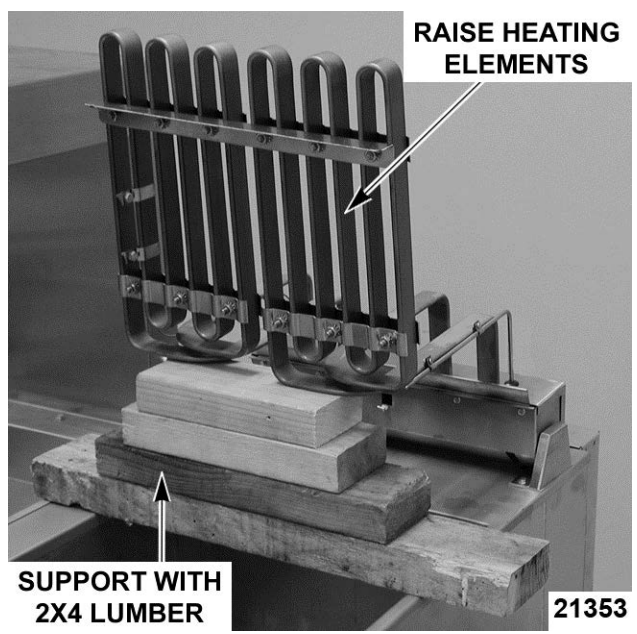

2. Loosen all eye bolt mounting nuts to release tension on springs.

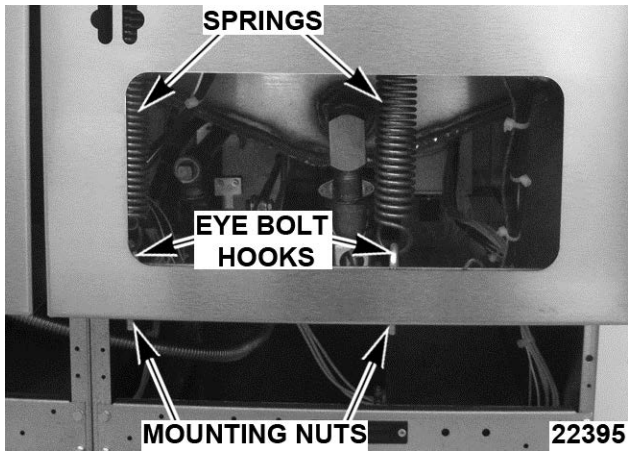

3. Remove lift assist springs from the eye bolt hooks.
4. Remove lift assist springs from the hangers.
5. To install springs:
 - A. Attach spring hook to hanger thru rear door opening.
 - B. Attach spring hook to eye bolt and tighten eye bolt mounting nut.

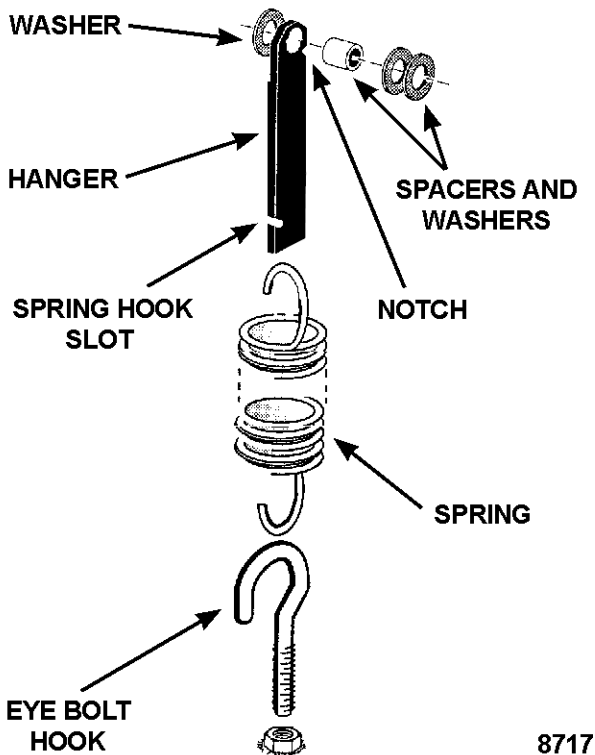

- C. Remove 2x4 lumber and lower heating elements.
6. Adjust spring tension as outlined under LIFT ASSIST SPRING ADJUSTMENT.

TILT SWITCH



⚠ WARNING

Disconnect the electrical power to the machine and follow lockout / tagout procedures. There may be multiple circuits. Be sure all circuits are disconnected.

1. Remove element head cover as outlined under COVERS AND PANELS.
2. Lower heating elements.
3. Disconnect lead wires from tilt switch.
4. Remove tilt switch from element head.

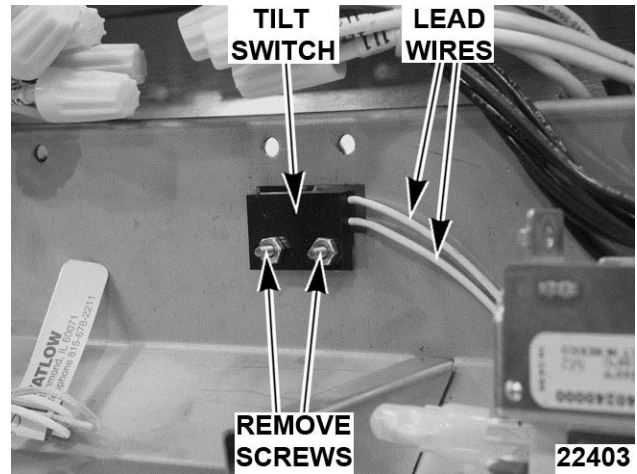

REAR VIEW SHOWN, ELEMENTS LOWERED

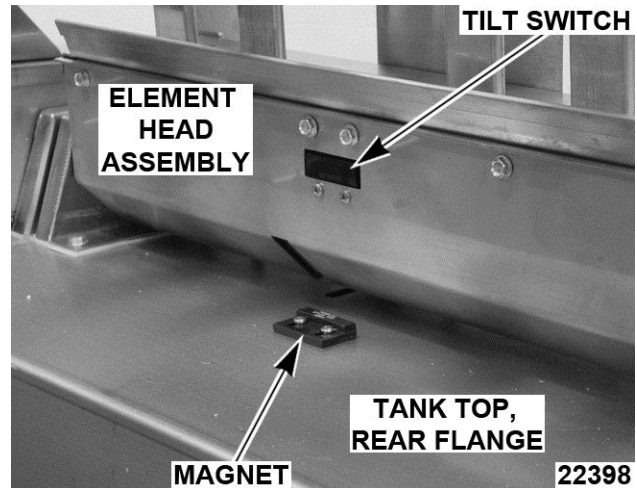

FRONT VIEW SHOWN, ELEMENTS RAISED

5. Reverse procedure to install and check for proper operation.

PUMP AND MOTOR (KLEENSCREEN FRYERS ONLY)



⚠ WARNING

Disconnect the electrical power to the machine and follow lockout / tagout procedures. There may be multiple circuits. Be sure all circuits are disconnected.

1. Drain filter tank of shortening.
2. Open the fryer section doors above the filter tank drawer.
3. Pull filter drawer out, remove filter tank assembly and push the tank support arms back into place under the fryer.
4. Remove splash guard from base frame.

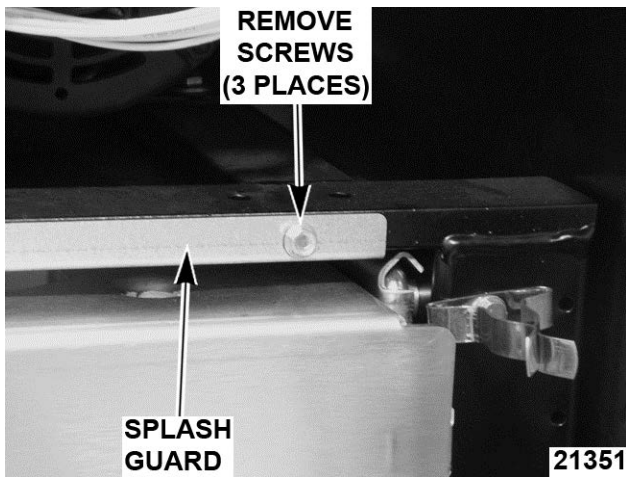

5. Disconnect pump motor lead wire connector.
6. From underneath the fryer: disconnect flexible line fittings from pump.
7. Remove pump motor assembly from fryer.

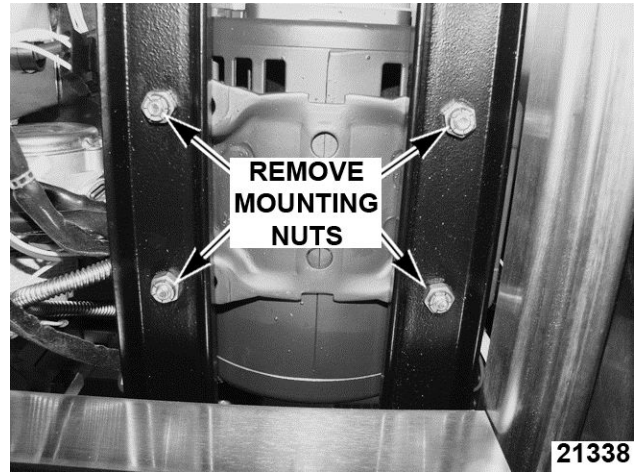

8. Remove pipe fittings from the pump and install on replacement pump.
9. Reverse procedure to install and check for proper operation.

SERVICE PROCEDURES AND ADJUSTMENTS

⚠ WARNING

Certain procedures in this section require electrical test or measurements while power is applied to the machine. Exercise extreme caution at all times. If test points are not easily accessible, disconnect power and follow lockout / tagout procedures, attach test equipment and reapply power to the test.

TEMPERATURE PROBE TEST

The temperature probe is an RTD (resistance temperature device) of the thermistor type. As temperature increases the resistance value decreases.

Probe Fault

NOTE: A temperature probe fault can be caused by a lead wire break or a lead short.

If a temperature probe fault occurs:

- The red diagnostic LED on back of control assembly (inside control box cover) will flash.
- The heat demand outputs are de-activated.

This will continue until the fault clears, power is cycled or problem resolved.

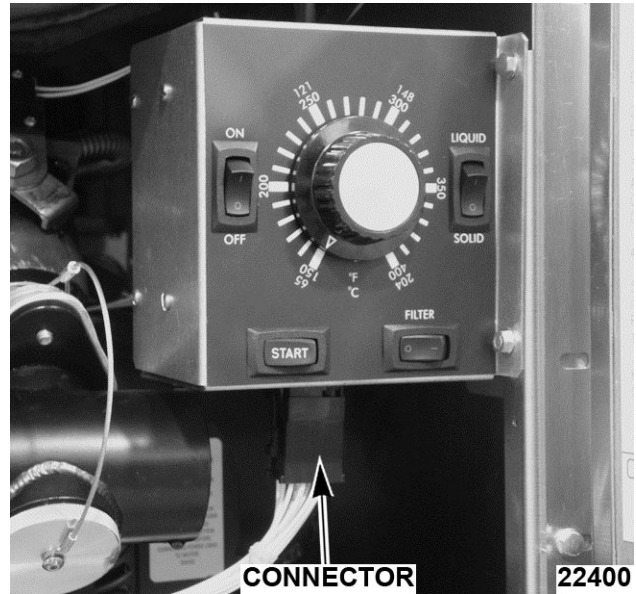

COOKING CONTROL ASSEMBLY

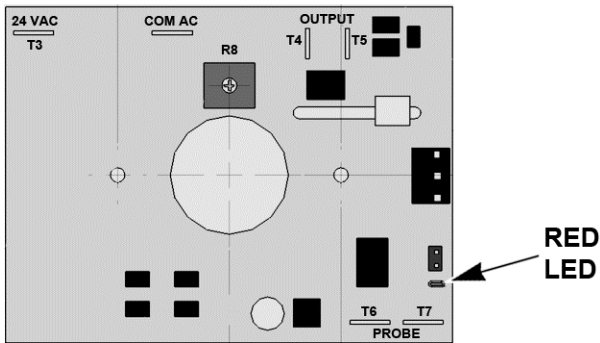

21341

To Check

1. Turn power switch off.
2. Disconnect cooking control connector.

3. Test the probe using a VOM to measure resistance. Connect the meter leads to pins 4 & 5 on the male connector.
 - A. If the measured resistance values are within the allowable range, the probe is functioning properly. Reverse procedure to install.
 - B. If the measured resistance values are outside the allowable range, install a replacement probe and check for proper operation.

Temperature (°F)	Resistance (Ω)
77	90K - 110K
212	5,016 - 6,130
275	1,804 - 2,204
300	1,254 - 1,534
350	646 - 790
392	391 - 478

COOKING CONTROL CALIBRATION

1. Verify condition of temperature probe as outlined under TEMPERATURE PROBE TEST.

2. Check the level of shortening in fry tank. The level must be between the MIN & MAX fill lines before proceeding.
3. Place clamp on type amp meter around any yellow lead wire of 2CON or 4CON.

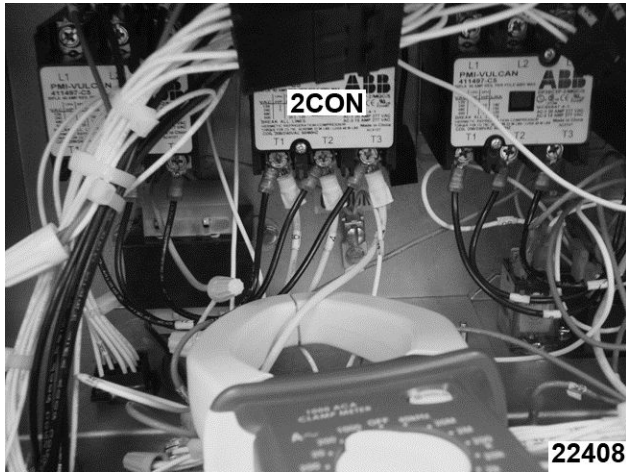

4. Allow shortening to cool below 300°F.
5. Place a thermocouple in the geometric center of the fry tank one inch below the shortening surface.
6. Set the cooking control to 350°F and turn the fryer on.
7. Monitor the current as it cycles on and off.

NOTE: Stir shortening to eliminate any cold zones.

- A. Allow heat to cycle three times to stabilize shortening temperature.
 - B. Record meter reading from thermocouple when the current cycles off and on for at least two complete heating cycles.
8. Calculate the average temperature by adding the temperature reading when the heat goes off to the temperature reading when the heat comes on & divide this answer by 2.

$$[\text{Temp. (Heat off)} + \text{Temp. (Heat on)}] \div 2 = \text{Average Temp.}$$

Example: $360^{\circ} + 340^{\circ} \div 2 = 350^{\circ}\text{F}$. The average temperature should be $350^{\circ}\text{F} (\pm 5^{\circ}\text{F})$.

- A. If the average temperature reading is within tolerance, cooking control is properly calibrated.
- B. If the average temperature reading is out of tolerance, loosen set screw to remove temperature knob and adjust calibration potentiometer.

NOTE: Ensure that the shaft and knob position does not change when loosening set screw and removing temperature knob, as this could affect calibration.

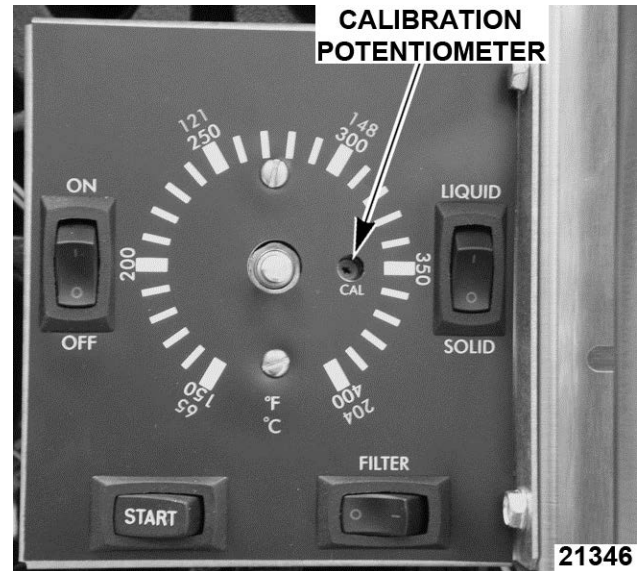

- Adjust calibration potentiometer clockwise to increase temperature.
- Adjust calibration potentiometer counterclockwise to decrease temperature.

C. If over 25° of adjustment is necessary, replace cooking control.

9. Repeat the average temperature calculation for up to three attempts. Allow the cooking control to cycle at least two times between adjustments before performing the calculation.
10. If calibration is unsuccessful, the cooking control may be malfunctioning and cannot be adjusted properly. Install a replacement cooking control and check calibration.

LIFT ASSIST SPRING ADJUSTMENT

1. Turn power switch off.
2. Check spring tension:
 - A. Raise heating elements to the full up position.
 - B. Lower heating elements to the full down position. Elements should remain in place.
 - C. If the elements remain in place as described, then no adjustment is necessary. If the elements do not remain in place, continue with procedure for adjustment.

3. Lower heating elements to the down position.
4. Loosen stop nut on all eye bolts.

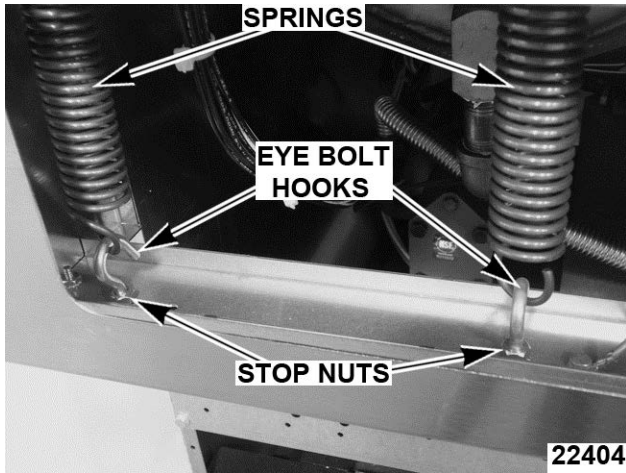

5. Adjust eye bolt mounting nuts as necessary, but equally on all springs to achieve the best spring tension to hold elements in place.

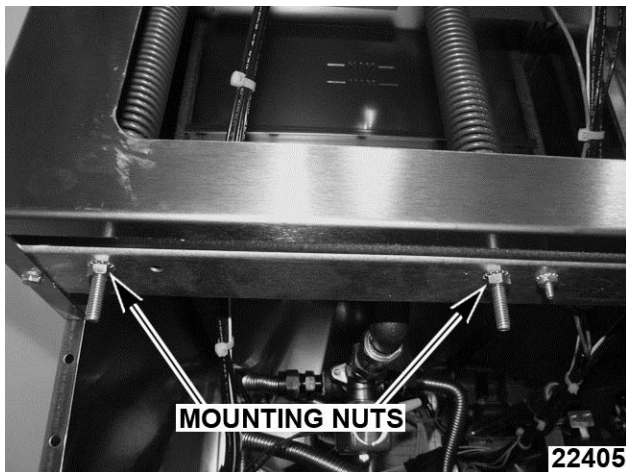

6. Perform spring tension check.
7. Repeat spring tension adjustment if necessary.
8. Tighten stop nut on all eye bolts.

HEATING ELEMENT TEST

CAUTION

Heating elements must remain submerged in shortening while performing this test or damage may occur.

1. Remove element head cover as outlined under COVERS AND PANELS.
2. Access heating element lead wire connections at wire nuts.
3. Re-connect power, turn power switch on and set cooking control to call for heat.

4. Measure voltage at heating element connections and verify against data plate voltage.

- A. If voltage is incorrect, see ALL MODELS.
- B. If voltage is correct, check current draw (amps) through the heating element lead wires. See table below for proper values.

NOTE: This method is preferred over a resistance check when a clamp on type amp meter is available.

- 1) If current draw is correct then heating element is functioning properly.
- 2) If current draw is not correct, turn power switch off and disconnect power to the machine.
 - a. Install a replacement heating element.
 - b. Proceed to last step.

- C. If unable to check current draw, a resistance check may indicate a malfunctioning element. See table for proper values.

- 1) Turn power switch off and disconnect power to the machine.
- 2) Remove wire nuts from heating element lead wire connections and separate lead wires.
- 3) Check resistance (ohms)

5. Check for proper operation.

VOLTAGE	TOTAL KW	AMPS PER ELEMENT	OHMS PER ELEMENT
208	14	11	18.4
	17	13.5	15.5
	24	19.2	10.8
240	14	9.6	25.1
	17	11.6	20.5
	24	16.7	14.4
480	14	4.8	100.1
	17	5.8	82.3
	21	7.3	65.8
	24	8.3	57.6

NOTE:

Values in the table are nominal. Tolerance is +5/-10%.

Resistance values (ohms) are @ room temperature.

There are 3 elements per firebar, 6 elements per tank.

ELECTRICAL OPERATION

COMPONENT FUNCTION

FRYER CONTROLS	
Cooking Control	Monitors and evaluates input signals to the control: Activates heat output signal to maintain shortening temperature; and activates filter output signal to power the fill solenoid valve.
Transformer	Supplies 24VAC to the cooking control circuit. Transformer is energized when power switch is turned on.
Power Switch	Supplies power to control circuit for fryer operation and filtering.
Melt Select Switch	Controls heating circuit operation during melt cycle based on type of shortening being used (liquid/ solid).
High Limit Thermostat	Prevents the shortening from reaching temperatures over 450°F (manual reset).
Temperature Probe	Senses temperature of shortening. Converts the temperature into a resistance which is monitored by the cooking control. The probe is an RTD (resistance temperature device) of the Thermistor type. As temperature increases the resistance value decreases.
Drain Valve Interlock Switch (DVI)	A magnetic reed switch mounted on the manual drain valve that supplies a drain valve position signal (open/ closed) to the cooking control. When drain valve is open, the drain interlock input to the control is removed (magnetic reed switch contacts open). This prevents heating elements from being energized with the fry tank empty.
Tilt Switch	A magnetic reed switch (N.O.) mounted underneath the element head assembly. Remove power from 1CON and 3CON to de-energize the heating elements when the elements are raised.
1CON, 3CON and 2CON, 4CON Contactors	Supplies line voltage to heating elements.
Heating Elements	Produces heat that is transferred to the shortening.
R1 Heat Relay	Supplies power to 2CON and 4CON contactor coils.
R2 Power Relay	Supplies power to cooking control.

KLEENSCREEN FILTER CONTROLS	
Fill Solenoid Valve	When energized by filter switch, the solenoid valve opens to allow the flow of shortening thru filtering system.
Pump Motor	Operates pump to circulate shortening through filtering system.

KLEENSCREEN FILTER CONTROLS	
Start Switch	Supplies start heating function to the temperature control at the beginning of a cooking cycle or after the vat has been filled from the filter process.
Filter Switch	Energizes pump motor to filter the shortening when switch is closed (valve handle extended). Filter power switch must be turned on.
Discard Valve Switch	A magnetic reed switch mounted on the mechanical discard valve that closes when discard valve handle is extended to discard the shortening. Prevents R4 solenoid relay N.C. contacts from supplying power to the fill solenoid valve when filter key is pressed.
R3 Filter Relay	Supplies power to pump motor and solenoid.
R4 Solenoid Relay	Removes power to solenoid if discard valve switch is operated.

COMPONENT LOCATION

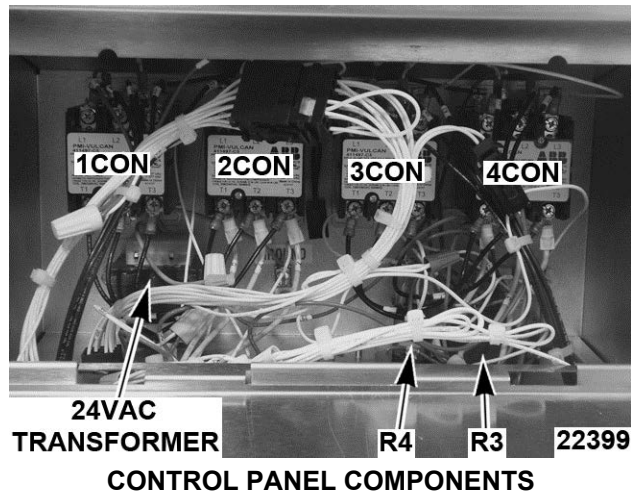
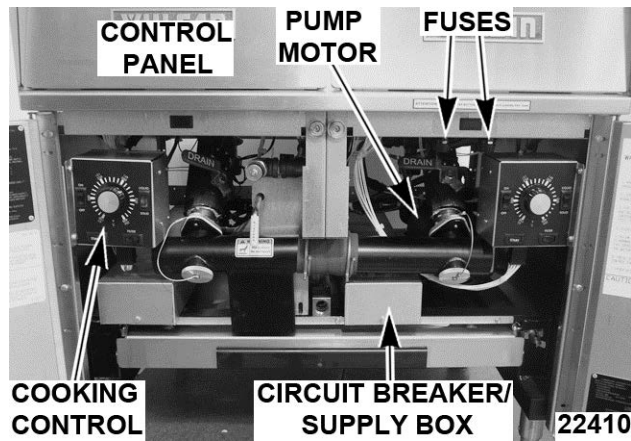

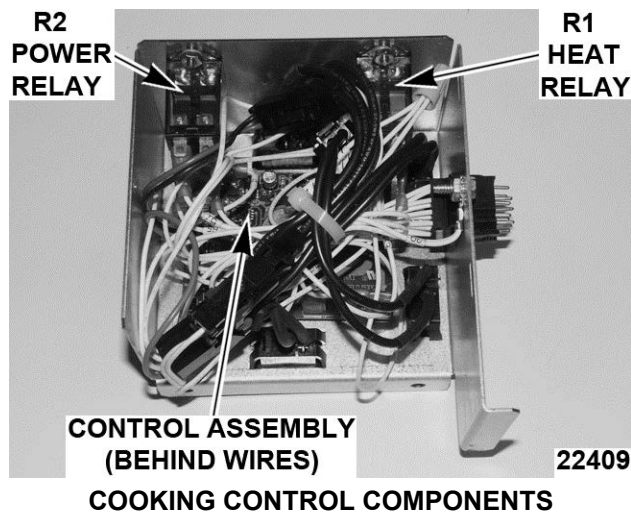

SEQUENCE OF OPERATION

Fryer

1. Conditions.
 - Fryer connected to correct supply voltage and is properly grounded. Separate connections are required for each section of the battery.
 - 120/24VAC transformer energized.
 - Internal fryer circuit breaker ON (24kW, 208-240V units only).
 - Power switch off.
 - Shortening at proper level in fry tank and below last set point temperature used.
 - Cooking control is setup properly and ready to use.
 - Manual drain valve closed (drain valve interlock switch N.O. is closed).
 - Tilt switch contacts closed (N.O. - held closed with heating elements lowered).
 - High limit thermostat closed.
2. Turn power switch on. Supply voltage energizes:
 - 1CON and 3CON thru high limit thermostat and tilt switch.
 - R2 power relay coil and R2 N.O. contacts close.
 - Cooking control thru DVI switch.
3. Press start momentary switch. If shortening temperature is below set point:
 - A. J5 outputs 24VDC to R1 thru wire 56.
 - B. R1 heat relay coil energized and R1 N.O. contacts close.
 - C. 2CON and 4CON are energized and heating elements are powered.
 4. Shortening reaches set temperature.
 - A. Cooking control de-activates the heat demand output (24VDC) at J5.
 - B. With power removed from J5, R1 is de-energized thru wire 56.
 - C. 2CON and 4CON are de-energized and power is removed from heating elements.
 5. Cooking control cycles heat output on shortening temperature until power switch is turned off, heating elements are raised or a high limit condition occurs.
 - A. If shortening reaches 460°F
 - The high limit thermostat opens
 - 1CON and 3CON are de-energized
 - Power is removed from heating elements.
 - B. 1CON and 3CON remain deenergized until:
 - Shortening temperature drops below 460°F.
 - Manual reset button is pressed.
 - Start button is actuated.

Filtering System

The discard valve handle is connected to a mechanical valve and switch assembly to route the flow of shortening (electrically and mechanically) in the filtering system.

Refer to Installation & Operation manual for specific instructions on filtering.

1. Conditions

- Fryer connected to correct supply voltage and is properly grounded.
- Power switch to the fryer section off.
- Shortening between 300°F and 350°F.
- Filter drawer assembly installed properly.
- Filter power switch off.
- Discard valve handle (yellow) retracted.
- Discard valve switch N.O. contacts open.
- Mechanical discard valve closed.

2. Turn power switch on, to the fryer section to be filtered.

NOTE: Shortening should not be filtered outside of this temperature range. At lower temperatures the shortening is thicker which may increase filtering time and place a greater load on the pump. At higher shortening temperatures, the pump seal life is decreased.

3. Set cooking control between 300°F (minimum) and 350°F (maximum).

NOTE: If using solid shortening, once it has melted, stir the shortening to eliminate any solid shortening in cold zone of the fry tank.

4. Allow shortening to cycle at set temperature for approximately 10 minutes.

NOTE: If using solid shortening, allow hot shortening to stand in filter tank for approximately 6 minutes prior to filtering.

5. Open the manual drain valve to the fryer section in need of and drain the shortening into filter tank. (Heat circuit will be disabled).

6. Turn filter power switch on

- R3 filter relay coil energized.
- R3 N.O. contacts close.
- Power supplied to pump motor and fill solenoid.

7. Pump motor circulates shortening through filter and solenoid to tank until power is removed.

NOTE: If using solid shortening, when all filtered shortening is returned to the fry tank and filter power switch is off, open the filter drawer approximately one inch. Allow the remaining shortening in the line to drain into the filter tank to prevent possible clogging after the shortening cools and solidifies.

8. When filtering process is completed and the tank is full, turn off filtering switch.

- Power is removed from pump motor and solenoid closes.

9. Close the filter drawer when complete.

10. To restart the cooking process, press the start button.

Discarding Shortening

The discard valve handle is connected to a mechanical valve and switch assembly to route the flow of shortening (electrically and mechanically) out discard hose.

Refer to Installation & Operation manual for specific instructions on draining.

1. Conditions

- Fryer connected to correct supply voltage and is properly grounded.
- Power switch to the fryer section off.
- Shortening between 300°F and 350°F.
- Filter drawer assembly installed properly.
- Filter power switch off.
- Discard valve handle (yellow) retracted.
- Discard valve switch N.O. contacts open.
- Mechanical discard valve closed.

2. Turn power switch on, to the fryer section to be drained.

NOTE: Shortening should not be drained outside of this temperature range. At lower temperatures the shortening is thicker which may increase draining time and place a greater load on the pump. At higher shortening temperatures, the pump seal life is decreased.

3. Set cooking control between 300°F (minimum) and 350°F (maximum).

NOTE: If using solid shortening, once it has melted, stir the shortening to eliminate any solid shortening in cold zone of the fry tank.

4. Allow shortening to cycle at set temperature for approximately 10 minutes.

NOTE: If using solid shortening, allow hot shortening to stand in filter tank for approximately 6 minutes prior to discarding.

5. Open the manual drain valve to the fryer section in need of discarding and drain the shortening into filter tank. (Heat circuit will be disabled).

6. Connect discard hose. Place other end of discard hose in appropriately-sized receptacle.

7. Pull out discard handle.
 - Discard switch N.O. contacts close.
 - R4 solenoid relay coil energized.
 - R4 N.C. contacts open.
8. Turn filter power switch on.
 - A. R3 filter relay coil energized.
 - B. R3 N.O. contacts close.
 - C. Power supplied to pump motor.
9. Pump motor circulates shortening out discard hose and into receptacle. If discard receptacle is not large enough to hold entire shortening amount
 - A. Turn filter switch off to stop pump motor.
 - B. Empty receptacle.
 - C. Resume discard operation by turning filter switch on.
10. When discard process is complete, turn off filter switch.
 - Power is removed from pump motor.
11. Push in discard handle.

SCHEMATIC DIAGRAMS

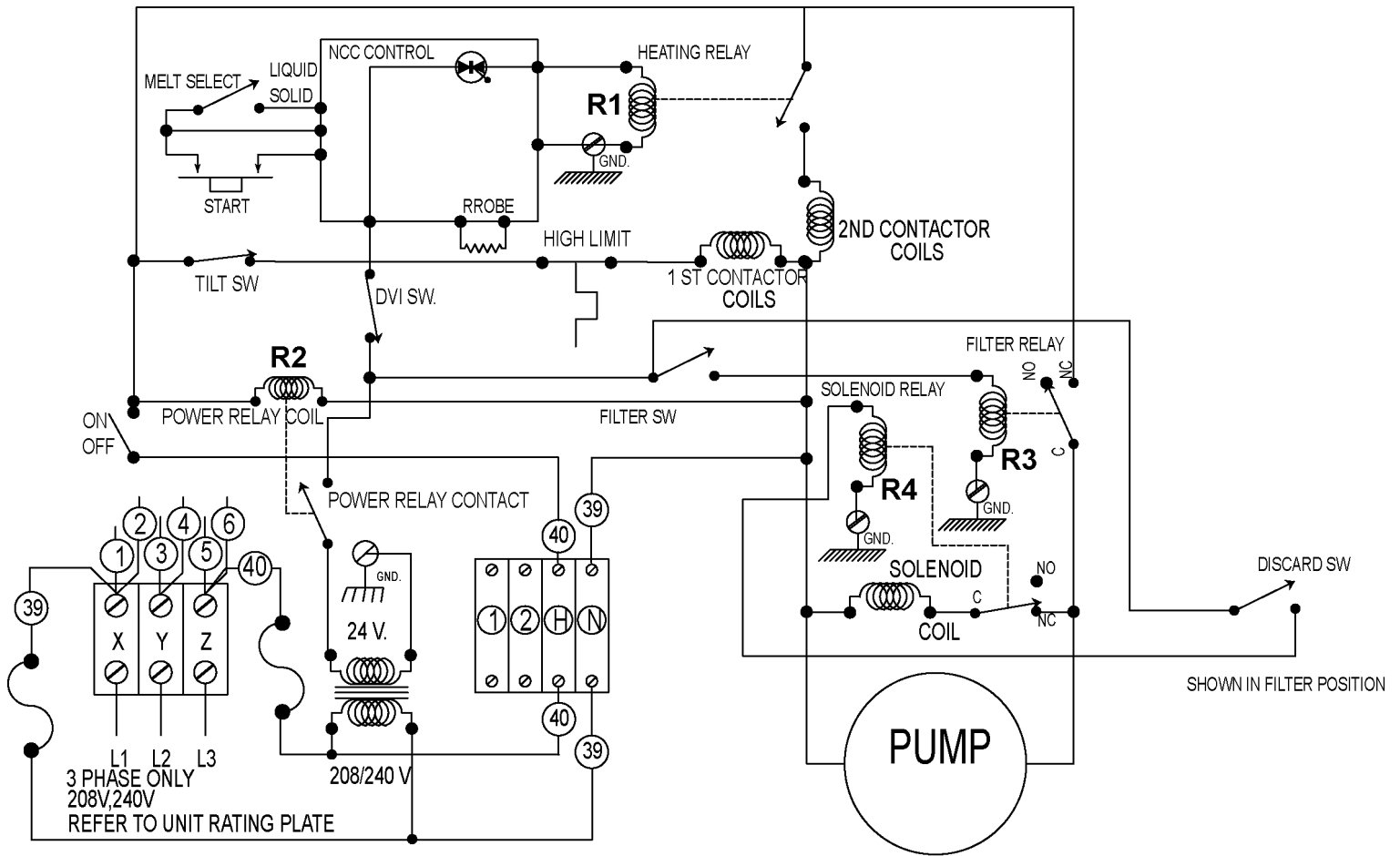

CHECK UNIT RATING
PLATE FOR THIS UNIT'S
KILOWATT POWER INPUT.

208-240 VOLT PHASE LOAD

TOTAL KW	KW/PHASE		
	X-Y	X-Z	Y-Z
24	8.0	8.0	8.0
17	5.6	5.6	5.6
14	4.6	4.6	4.6
AMPS PER LINE 208 VOLT			
	X	Y	Z
24	67	67	67
17	47	47	47
14	39	39	39
AMPS PER LINE 240 VOLT			
	X	Y	Z
24	58	58	58
17	41	41	41
14	34	34	34

**DERIVED FROM
957331-2 REV C**

AI 2858

208V & 240V Fryers Shown With KleenScreen Filtration System

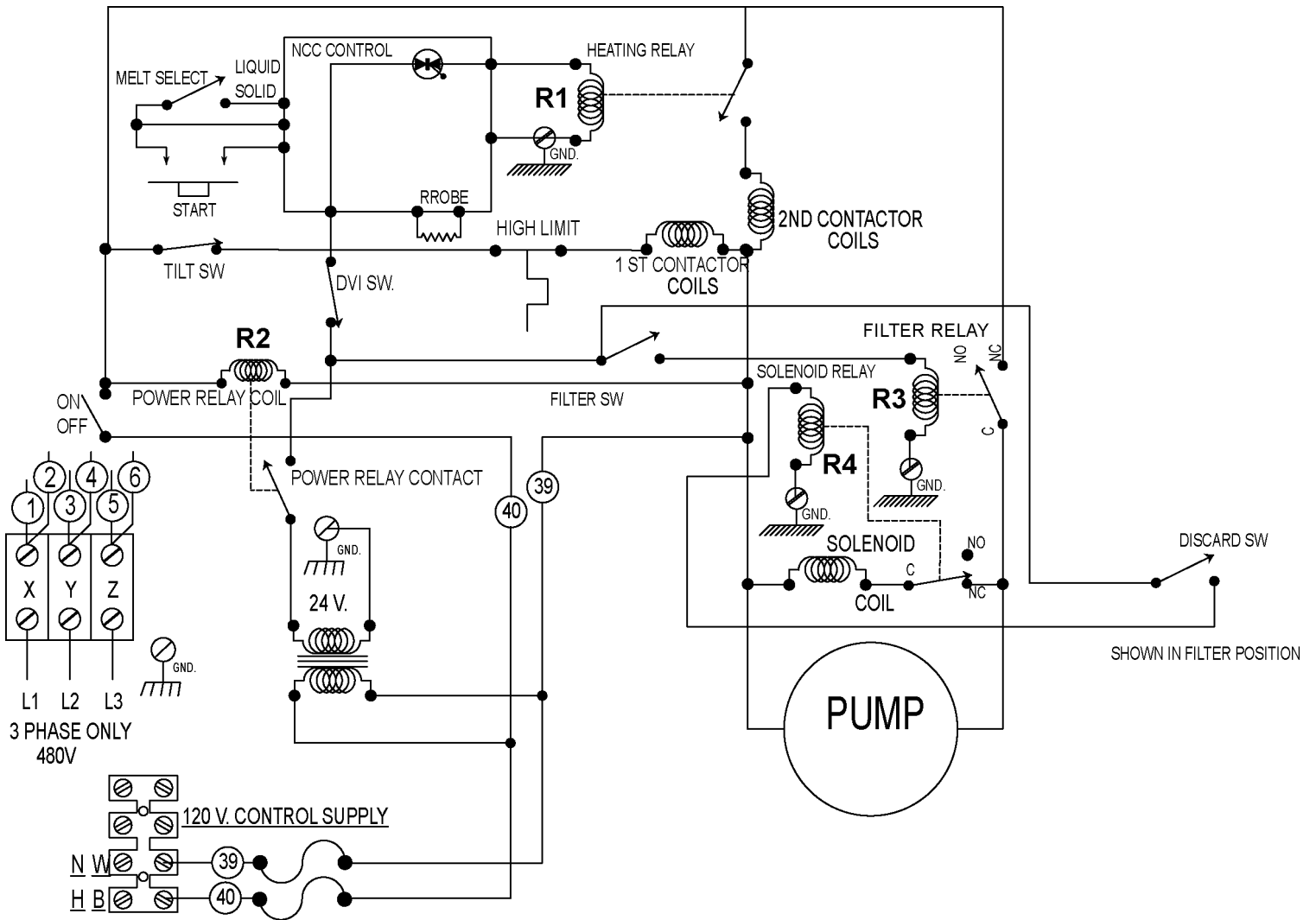

UNIT CONTAINS 2 SOURCES OF SUPPLY
ENSURE BOTH ARE OFF BEFORE SERVICING

CHECK UNIT RATING
 PLATE FOR THIS UNIT'S
 KILOWATT POWER INPUT.

480 VOLT PHASE LOAD

TOTAL KW	KW/PHASE		
	X-Y	X-Z	Y-Z
24	8	8	8
17	5.66	5.66	5.66
14	4.66	4.66	4.66
	AMPS PER LINE		
	X	Y	Z
24	29	29	29
17	20	20	20
14	17	17	17

**DERIVED FROM
 957332-2 REV C**

AI 2859

480V Fryers Shown With KleenScreen Filtration System

WIRING DIAGRAMS

Refer to: Diagrams (11 x 17 pdf file)

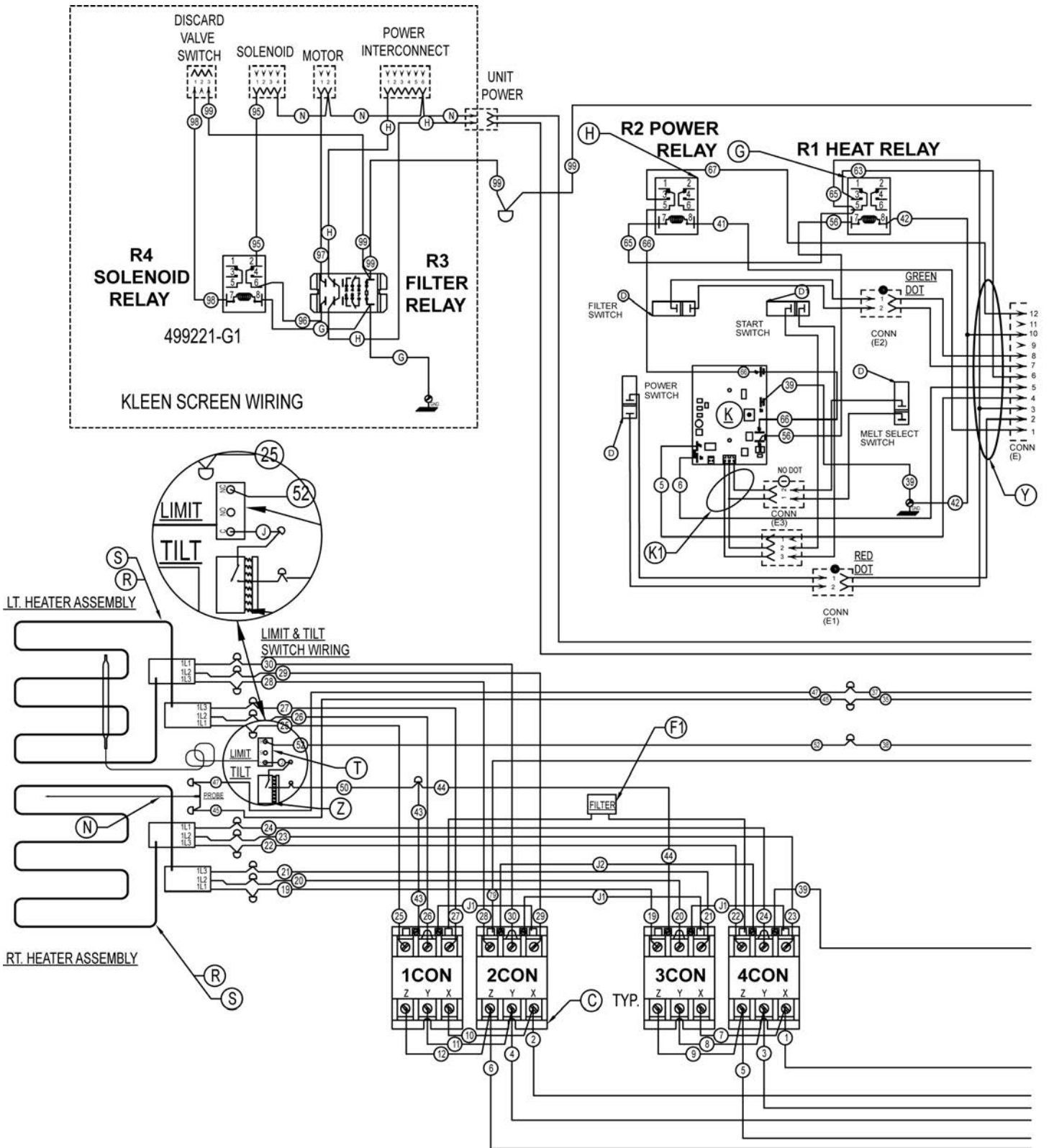

AI 2860

208V & 240V (14, 17 kW) Fryers Shown With KleenScreen Filtration System (Sheet 1)

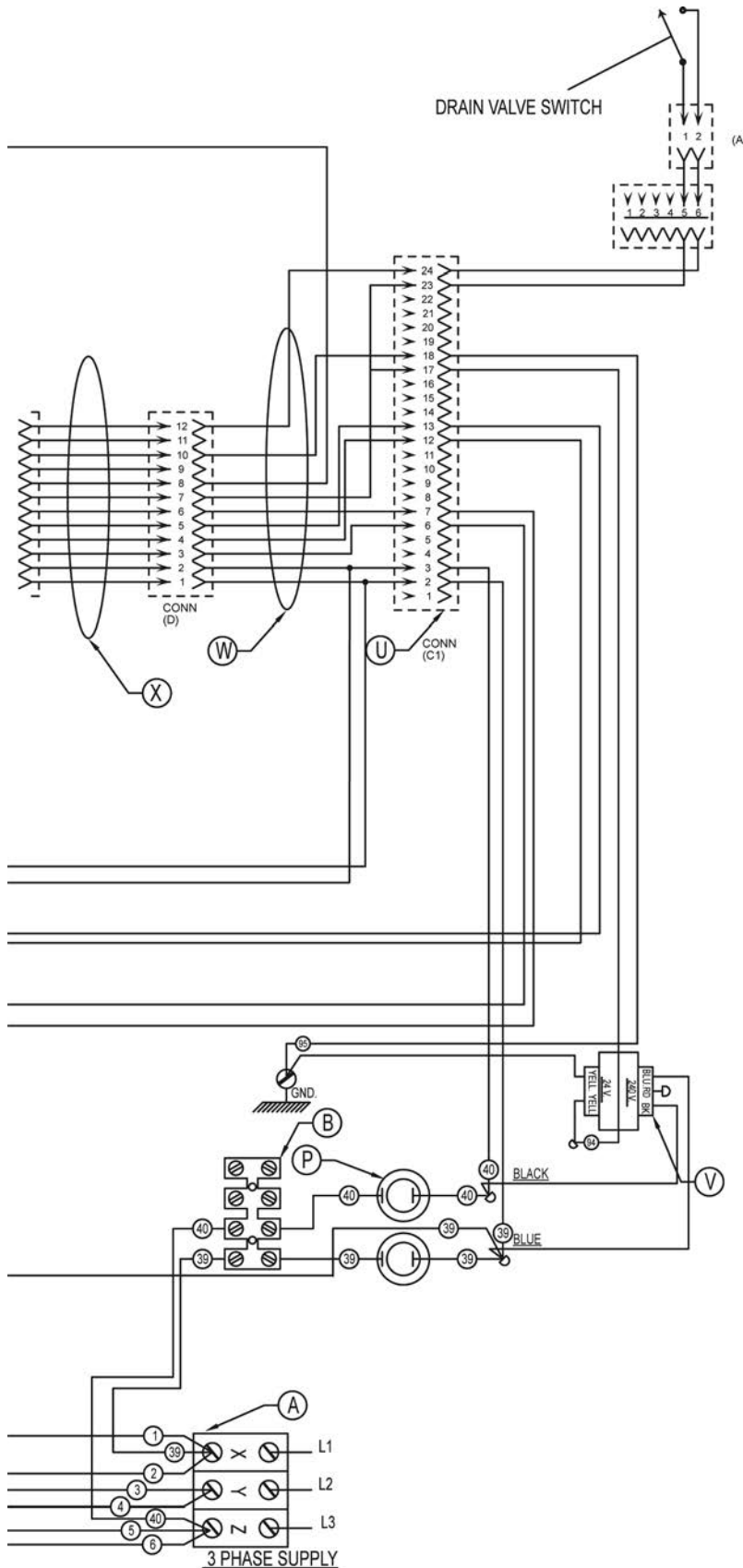

208-240 VOLT PHASE LOAD

TOTAL KW	KW/PHASE		
	X-Y	X-Z	Y-Z
17	5.6	5.6	5.6
14	4.6	4.6	4.6
AMPS PER LINE 208 VOLT			
	X	Y	Z
17	47	47	47
14	39	39	39
AMPS PER LINE 240 VOLT			
	X	Y	Z
17	41	41	41
14	34	34	34

1	1	F1	FILTER ASSEMBLY SINGLE	
1	1	Z	SWITCH, LIMIT	WIRED MAGNET
1	1	Y	HARNESS-CONTROL BOX	
1	1	X	HARNESS-POWER TO CONTROL BOX	
1	1	V	TRANSFORMER 40 VA. 240V/24V.	
1	-	W	HARNESS-POWER DISTRIBUTION	
1	1	U	HARNESS-CABLE ASSEMBLY	
1	1	T	2ED HIGH LIMIT 460 F	
2	-	S	ELEMENT, FIREBAR 8.5KW	208 V. 240 V.
-	2	R	ELEMENT, FIREBAR 7KW	208 V. 240 V.
2	2	P	FUSE & HOLDER	HOLDER FUSE
1	1	N	THERMISTOR PROBE	
1	1	K1	NCC CONTROL HARNESS	
1	1	K	NCC TEMPERATURE CONTROL	
1	1	H	RELAY, DPDT 240V COIL	
1	1	G	RELAY, DPDT 24V COIL	
1	1	D1	ROCKER SWITCH ASSEMBLY- START	
2	2	D	ROCKER SWITCH ASSEMBLY	
4	4	C	CONTACTOR 3P 40A 230V COIL	
1	1	B	STRIP-TERMINAL BARRIER	
1	1	A	TERMINAL BLOCK	

DERIVED FROM
956934-2 REV. C

AI 2861

208V & 240V (14, 17 kW) Fryers Shown With KleenScreen Filtration System (Sheet 2)

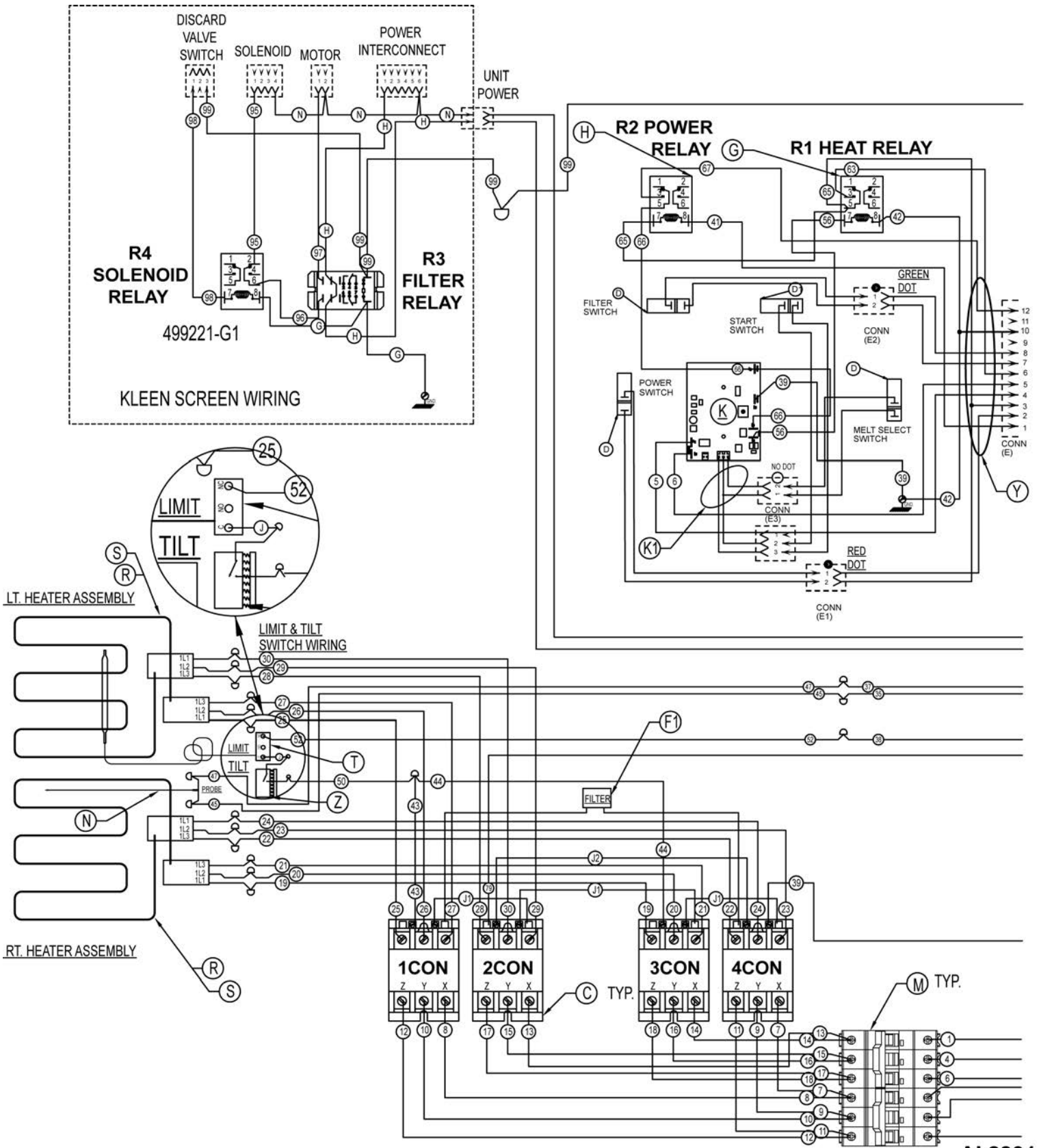

AI 2891

208V & 240V (24 kW) Fryers Shown With KleenScreen Filtration System (Sheet 1)

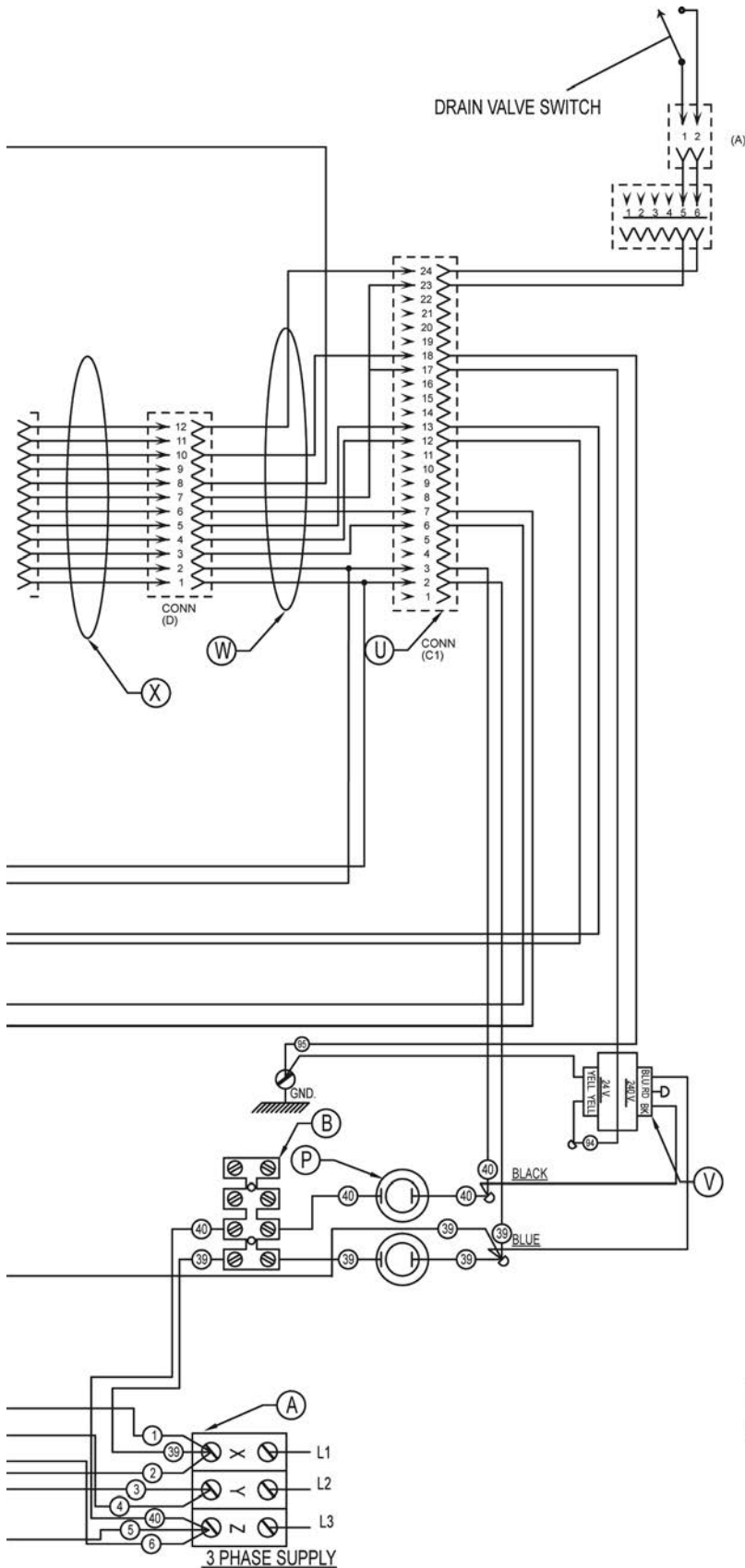

208-240 VOLT PHASE LOAD

TOTAL KW	KW/PHASE		
	X-Y	X-Z	Y-Z
24	8	8	8
AMPS PER LINE 208 VOLT			
	X	Y	Z
24	67	67	67
AMPS PER LINE 240 VOLT			
	X	Y	Z
24	58	58	58

1	-	F1	FILTER ASSEMBLY SINGLE	
1	-	Z	SWITCH, LIMIT	WIRED MAGNET
1	-	Y	HARNES-CONTROL BOX	
1	-	X	HARNES-POWER TO CONTROL BOX	
1	-	W	HARNES-POWER DISTRIBUTION	
1	-	V	TRANSFORMER, 40 VA 240V/24V.	
1	-	U	HARNES-CABLE ASSEMBLY	
1	-	T	2ED HIGH LIMIT 460 F	
2	-	S	ELEMENT, FIREBAR 12KW	208 V. 240 V.
2	-	P	FUSE & HOLDER	HOLDER FUSE
1	-	N	THERMISTOR PROBE	
2	-	M	CIRCUIT BREAKER 50A 3 POLE	
1	-	L	RELAY, TYCO T92S11 DPDT 24V COIL	
1	-	K1	NCC CONTROL HARNES	
1	-	K	NCC TEMPERATURE CONTROL	
1	-	H	RELAY, DPDT 240V COIL	
2	-	G	RELAY, DPDT 24V COIL	
1	-	D1	ROCKER SWITCH ASSEMBLY- START	
3	-	D	ROCKER SWITCH ASSEMBLY	
4	-	C	CONTACTOR 3P 40A 230V COIL	
1	-	B	STRIP-TERMINAL BARRIER	
1	-	A	TERMINAL BLOCK	

DERIVED FROM
956933-2 REV. C

AI 2892

208V & 240V (24 kW) Fryers Shown With KleenScreen Filtration System (Sheet 2)

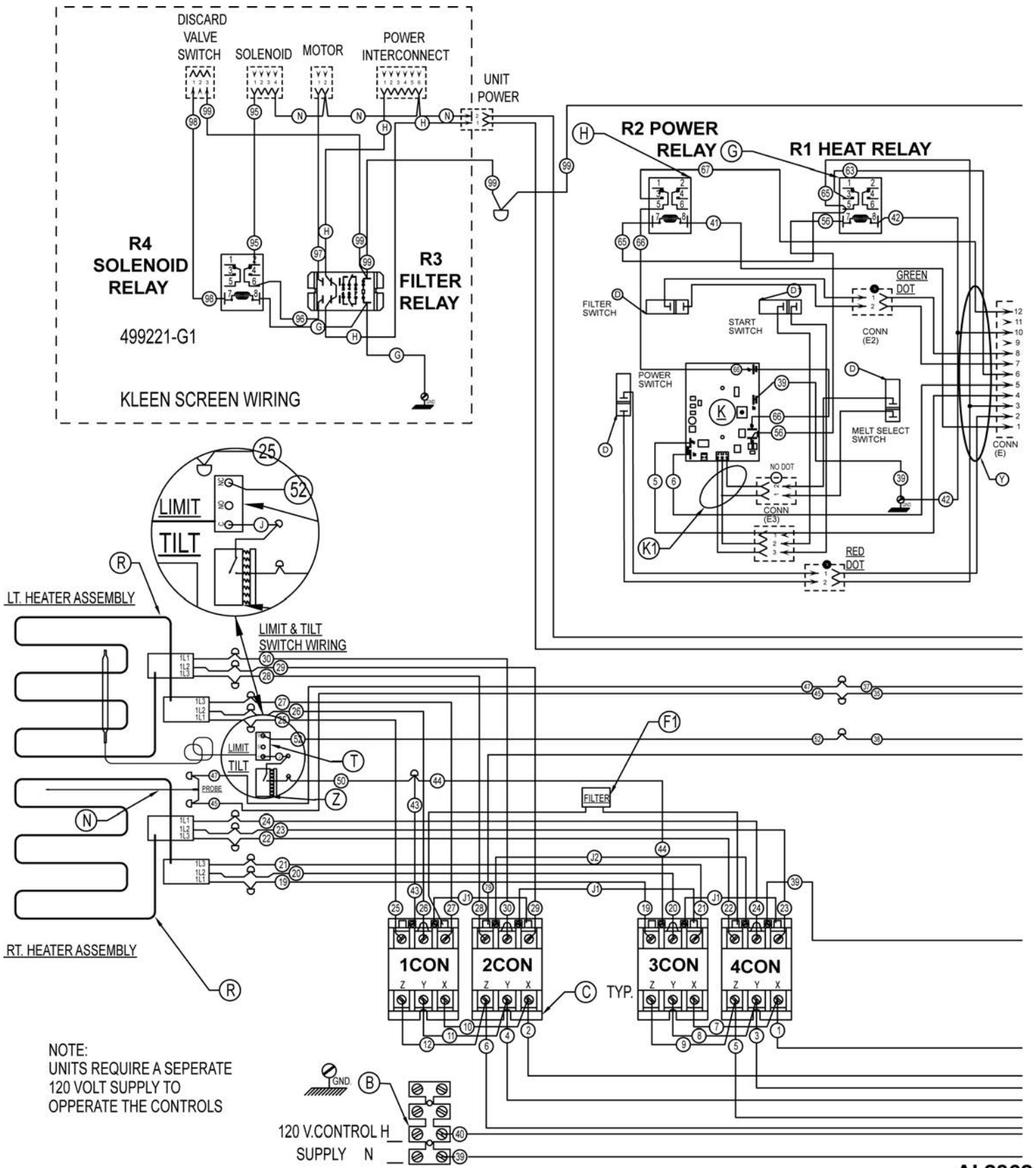

NOTE:
UNITS REQUIRE A SEPARATE
120 VOLT SUPPLY TO
OPERATE THE CONTROLS

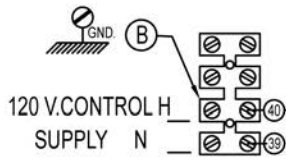

AI 2862

480V Fryers Shown With KleenScreen Filtration System (Sheet 1)

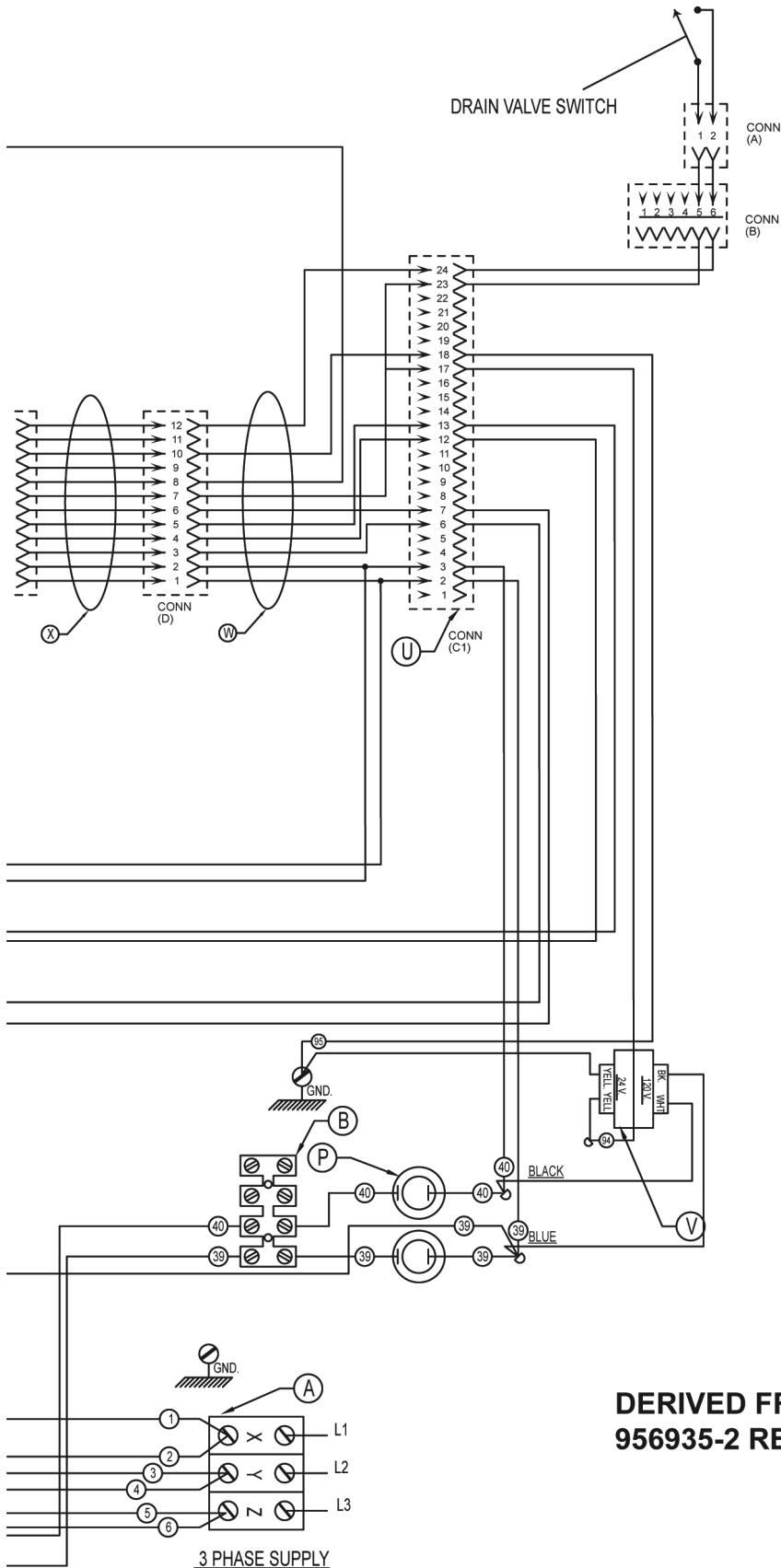

480 VOLT PHASE LOAD

TOTAL KW	KW/PHASE		
	X-Y	X-Z	Y-Z
24	8	8	8
17	5.66	5.66	5.66
14	4.66	4.66	4.66
AMPS PER LINE			
	X	Y	Z
24	29	29	29
17	20	20	20
14	17	17	17

1	1	1	-	F1	FILTER ASSEMBLY SINGLE	
1	1	1	-	Z	SWITCH, LIMIT	WIRED MAGNET
1	1	1	-	Y	HARNES-CONTROL BOX	
1	1	1	-	X	HARNES-POWER TO CONTROL BOX	
1	1	1	-	W	HARNES-POWER DISTRIBUTION	
1	1	1	1	V	TRANSFORMER, 40VA 120/24VAC	
1	1	1	1	T	2ED HIGH LIMIT 460F	
2	-	-	-	R3	ELEMENT, FIREBAR 480V. 12 KW.	
-	2	-	-	R3	ELEMENT, FIREBAR 480V. 10.5 KW.	
-	-	2	-	R2	ELEMENT, FIREBAR 480V. 8.5 KW.	
-	-	-	2	R1	ELEMENT, FIREBAR 480V. 7 KW.	
2	2	2	2	P	FUSE & HOLDER	HOLDER FUSE
1	1	1	1	N	THERMISTOR PROBE	
1	1	1	1	K1	NCC CONTROL HARNES	
1	1	1	1	K	NCC TEMPERATURE CONTROL	
1	1	1	1	H	RELAY DPDT 120V COIL	
1	1	1	1	G	RELAY, DPDT 24V COIL	
1	1	1	1	D1	ROCKER SWITCH ASSEMBLY - START	
2	2	2	2	D	ROCKER SWITCH ASSEMBLY	
4	4	4	4	C	CONTACTOR 3P 40A 120V COIL	
2	2	2	2	B	STRIP-TERMINAL BARRIER	
1	1	1	1	A	TERMINAL BLOCK	

DERIVED FROM
956935-2 REV. D

AI 2863

480V Fryers Shown With KleenScreen Filtration System (Sheet 2)

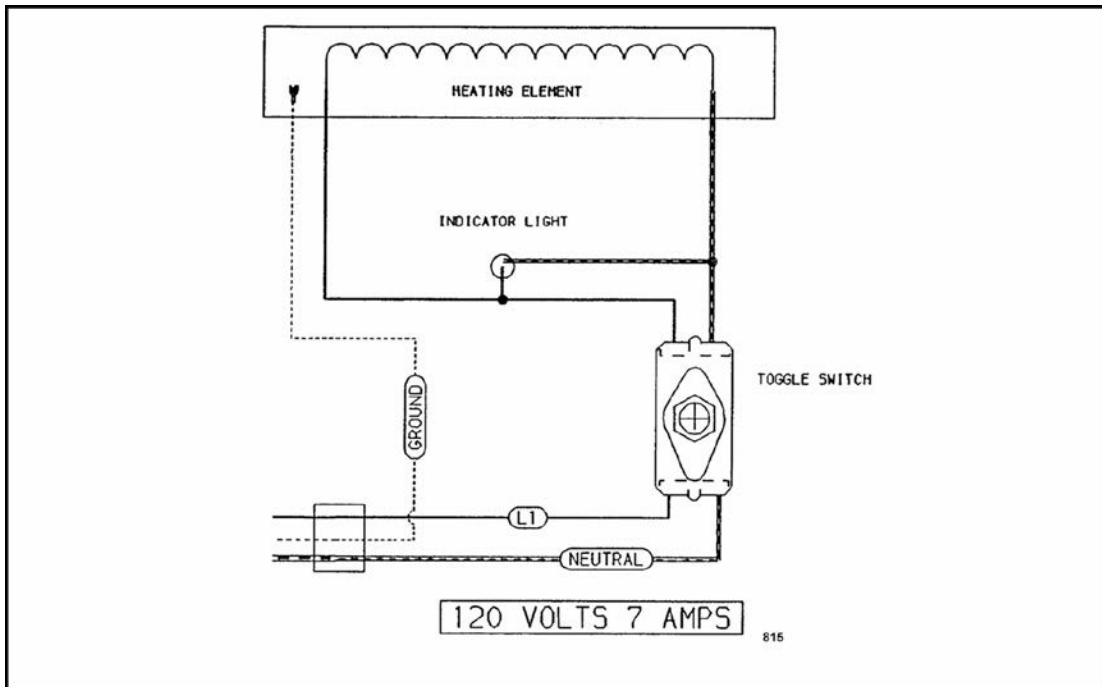

Frymate (Dump Station)

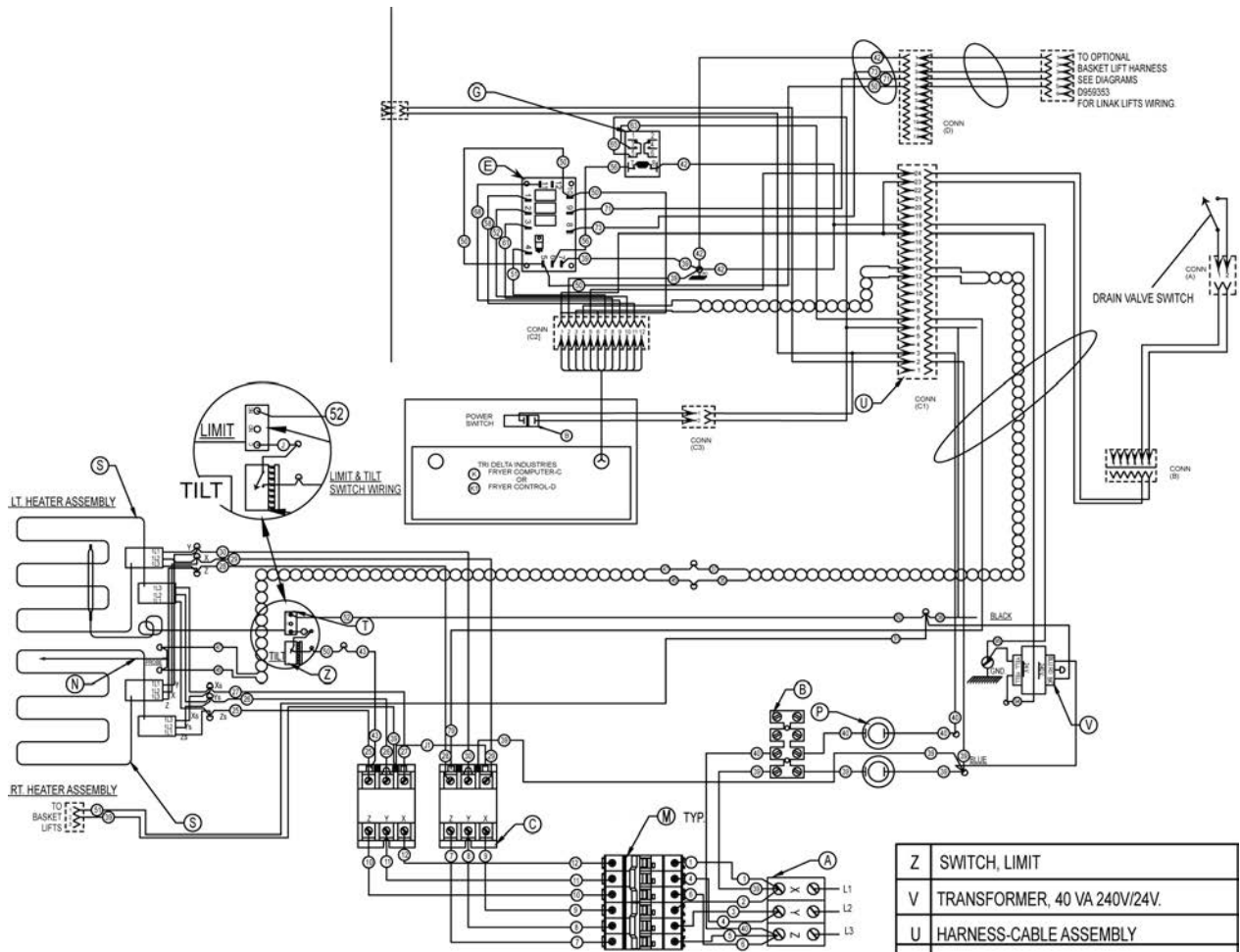

208-240 VOLT PHASE LOAD

TOTAL KW	KW/PHASE		
	X-Y	X-Z	Y-Z
24	8	8	8
AMPS PER LINE 208 VOLT			
	X	Y	Z
24	67	67	67
AMPS PER LINE 240 VOLT			
	X	Y	Z
24	58	58	58

WIRING DIA. 208 & 240 VOLT DIGITAL
 24 KW. STAND ALONE SOLID STATE SWITCHING
 3 PHASE SUPPLY

Z	SWITCH, LIMIT
V	TRANSFORMER, 40 VA 240V/24V.
U	HARNESS-CABLE ASSEMBLY
T	2ED HIGH LIMIT 460 F
S	ELEMENT, FIREBAR 12KW
P	FUSE & HOLDER
N	THERMISTOR PROBE
M	CIRCUIT BREAKER 50A 3 POLE
K1	NCC CONTROL W/TIMER(S)
K	NCC COMPUTER
G	RELAY, DPDT 24V COIL
E	CONTROL, INTERFACE TRIDELTA
D	ROCKER SWITCH ASSEMBLY
C	CONTACTOR 3P 50A 230V COIL
B	STRIP-TERMINAL BARRIER
A	TERMINAL BLOCK

DERIVED FROM 00-959321-1 Rev B Refer to Schematic 428281-1

AI4996

Fig. 45

ERA / EBD ELECTRIC FRYER - ELECTRICAL OPERATION

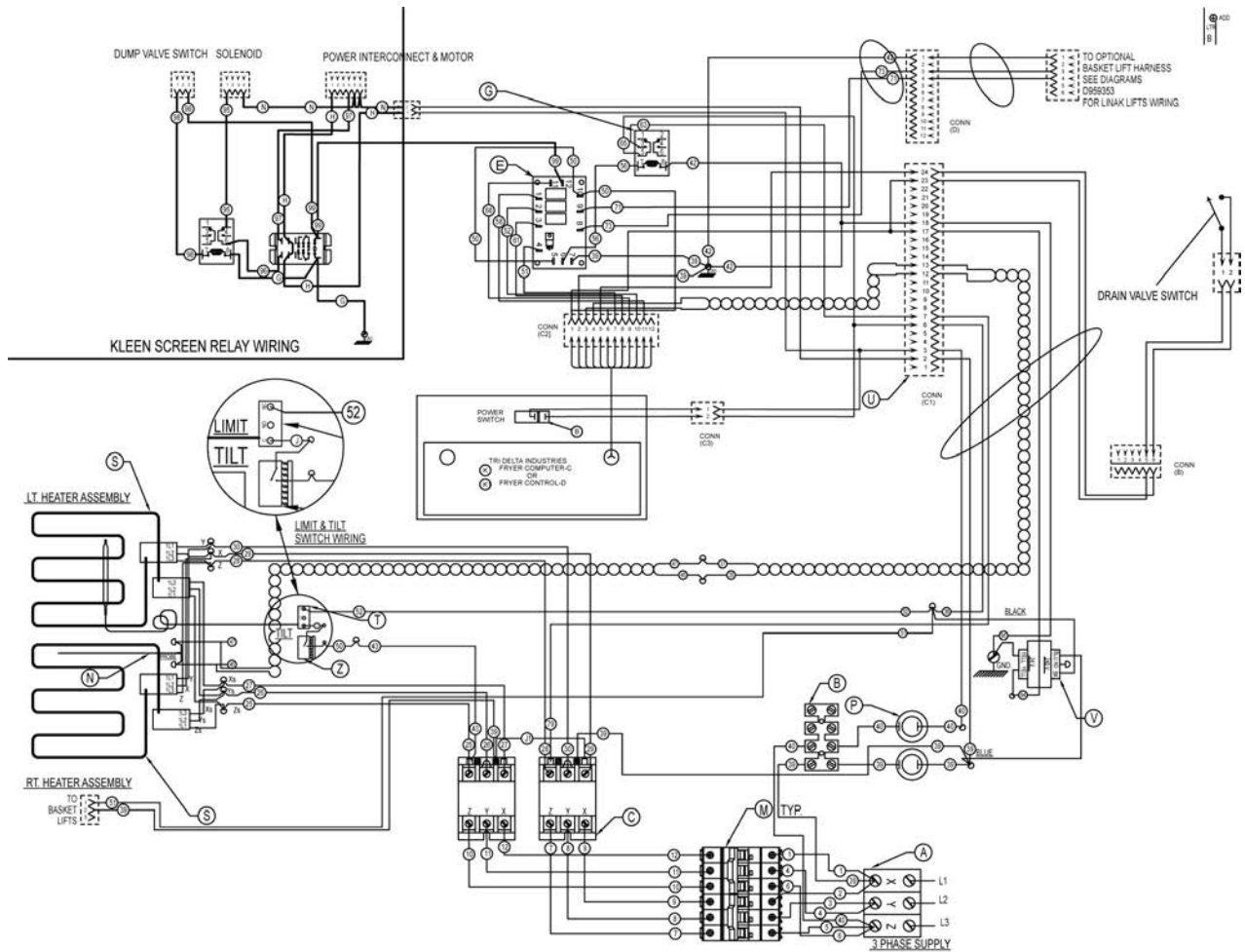

208-240 VOLT PHASE LOAD

TOTAL KW	KW/PHASE		
	X-Y	X-Z	Y-Z
24	8	8	8
AMPS PER LINE 208 VOLT			
24	67	67	67
AMPS PER LINE 240 VOLT			
24	58	58	58

Z	SWITCH, LIMIT
V	TRANSFORMER 40 VA. 240V./24V.
U	HARNES-CABLE ASSEMBLY
T	2ED HIGH LIMIT 460 F
S	ELEMENT, FIREBAR 12KW
P	FUSE & HOLDER
N	THERMISTOR PROBE
M	CIRCUIT BREAKER 50A 3 POLE
K1	NCCC CONTROL W/ TIMER(S)
K	NCCC COMPUTER
G	RELAY, DPDT 24V COIL
E	CONTROL, INTERFACE TRIDELTA
D1	ROCKER SWITCH ASSEMBLY- START
D	ROCKER SWITCH ASSEMBLY
C	CONTACTOR 3P 50A 230V COIL
B	STRIP-TERMINAL BLOCK
A	TERMINAL BLOCK

WIRING DIA. 208 & 240 VOLT DIGITAL
 24 KW. MASTER SOLID STATE SWITCHING

DERIVED FROM 00959321-2 Rev B Refer to Schematic 428281-1

A14997

Fig. 46

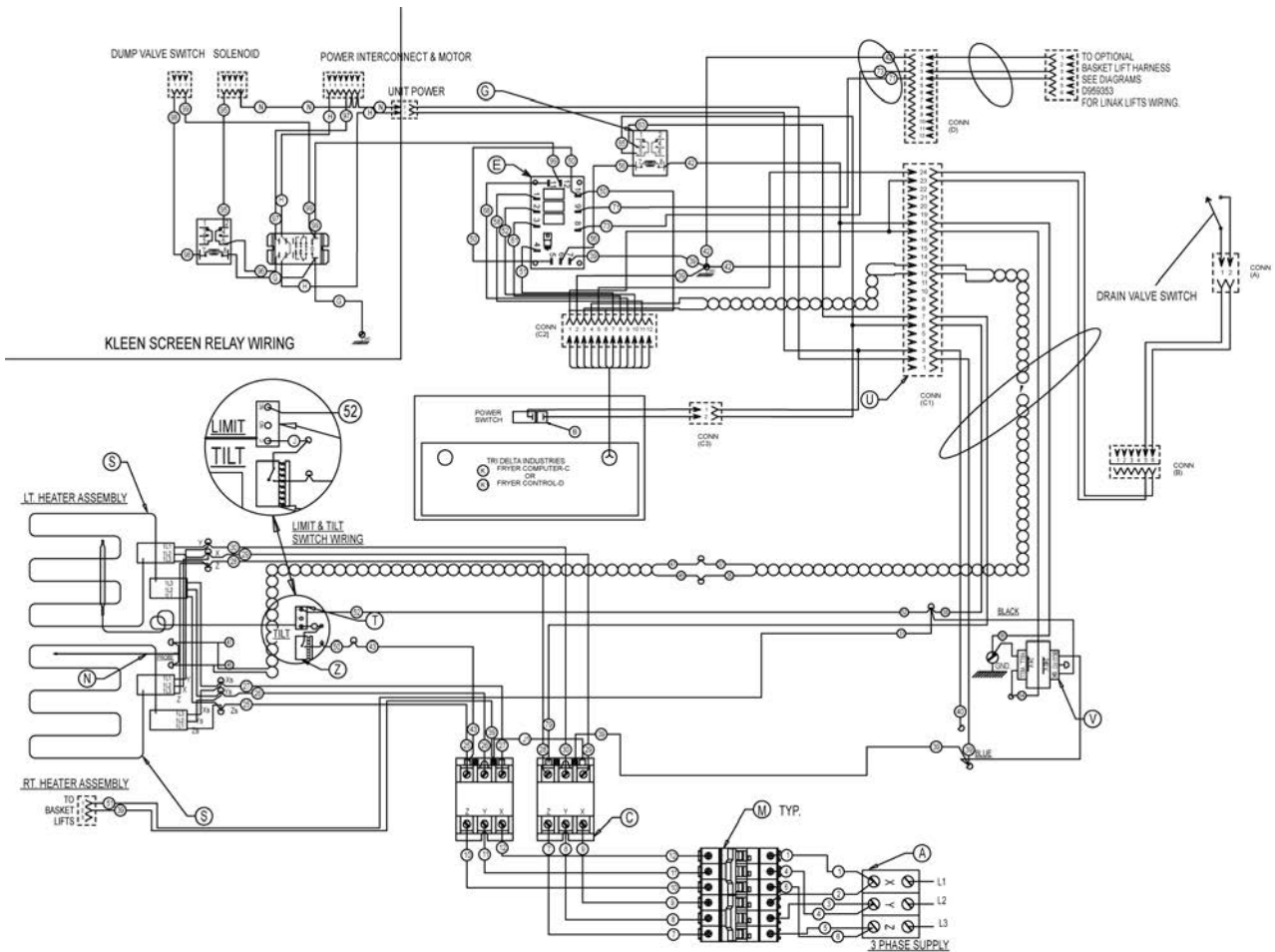

208-240 VOLT PHASE LOAD

TOTAL KW	KW/PHASE		
	X-Y	X-Z	Y-Z
24	8	8	8
AMPS PER LINE 208 VOLT			
	X	Y	Z
24	67	67	67
AMPS PER LINE 240 VOLT			
	X	Y	Z
24	58	58	58

Z	SWITCH, LIMIT
V	TRANSFORMER 40 VA. 240V./24V.
U	HARNES-CABLE ASSEMBLY
T	2ED HIGH LIMIT 460 F
S	ELEMENT, FIREBAR 12KW
N	THERMISTOR PROBE
M	CIRCUIT BREAKER 50A 3 POLE
K1	NCC CONTROL W / TIMER(S)
K	NCC COMPUTER
G	RELAY, DPDT 24V COIL
E	CONTROL, INTERFACE TRIDELTA
D	ROCKER SWITCH ASSEMBLY
C	CONTACTOR 3P 50A 230V COIL
A	TERMINAL BLOCK

WIRING DIA. 208 & 240 VOLT DIGITAL

24 KW. SLAVE SOLID STATE SWITCHING

DERIVED FROM 00959321-3 Rev B Refer to Schematic 428281-1

AI4998

Fig. 47

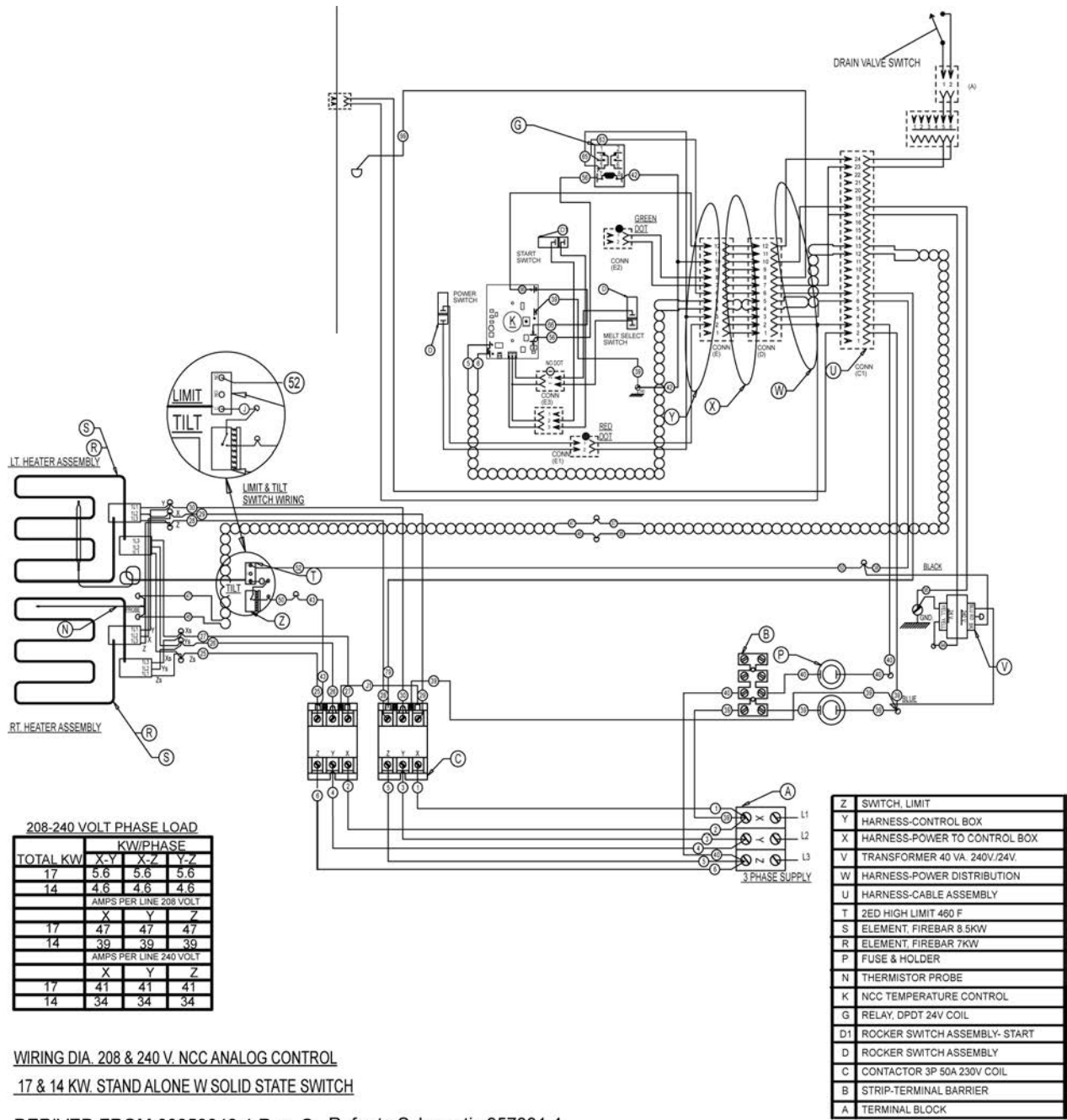

WIRING DIA. 208 & 240 V. NCC ANALOG CONTROL
 17 & 14 KW. STAND ALONE W SOLID STATE SWITCH

DERIVED FROM 00959348-1 Rev C Refer to Schematic 957331-1

AI4999

Fig. 48

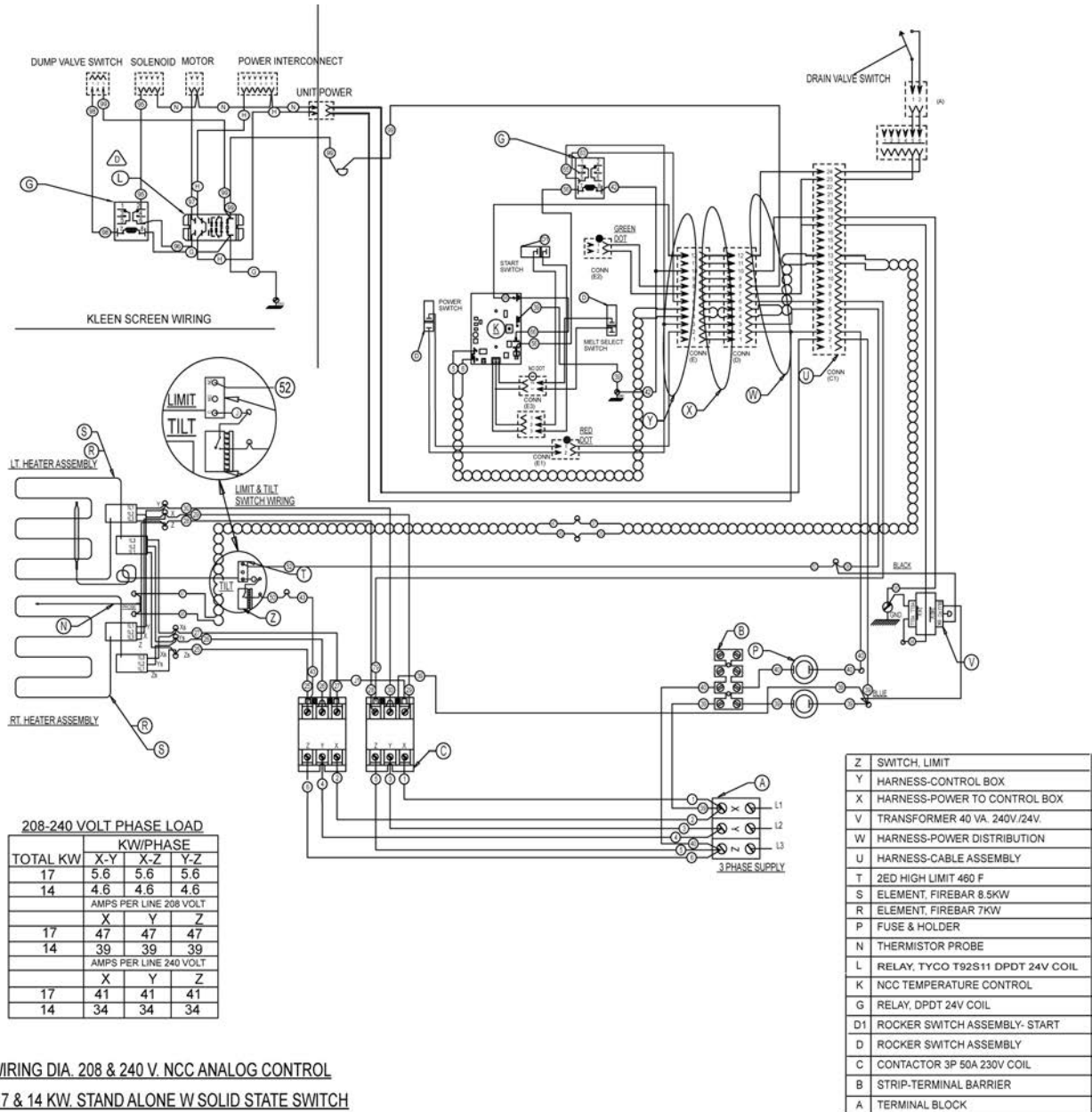

WIRING DIA. 208 & 240 V. NCC ANALOG CONTROL
 17 & 14 KW. STAND ALONE W SOLID STATE SWITCH

DERIVED FROM 00959348-2 Rev C Refer to Schematic 957331-2

AI5000

Fig. 49

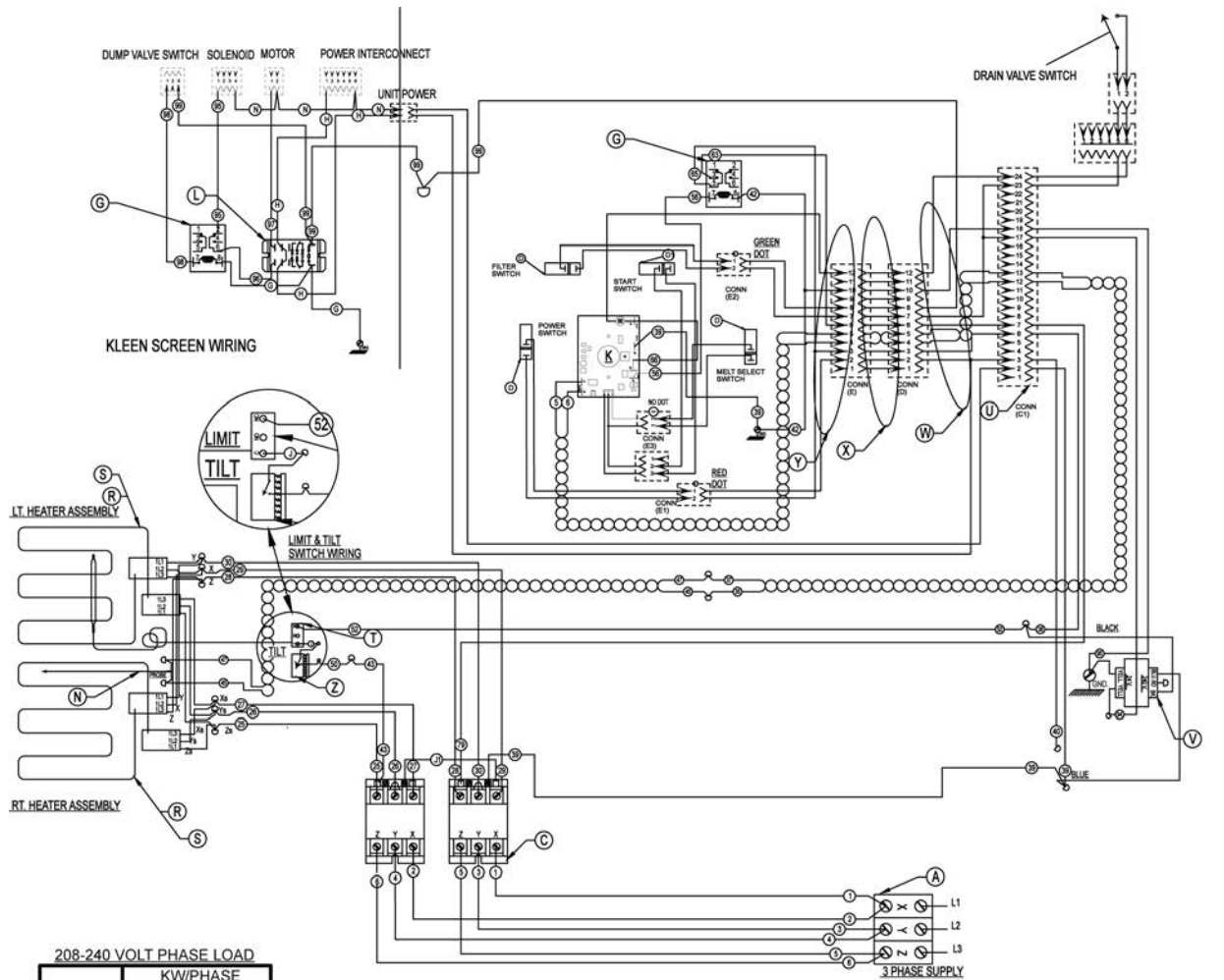

208-240 VOLT PHASE LOAD

TOTAL KW	KW/PHASE		
	X-Y	X-Z	Y-Z
17	5.6	5.6	5.6
14	4.6	4.6	4.6
AMPS PER LINE 208 VOLT			
	X	Y	Z
17	47	47	47
14	39	39	39
AMPS PER LINE 240 VOLT			
	X	Y	Z
17	41	41	41
14	34	34	34

Z	SWITCH, LIMIT
Y	HARNES-CONTROL BOX
X	HARNES-POWER TO CONTROL BOX
V	TRANSFORMER 40 VA. 240V./24V.
W	HARNES-POWER DISTRIBUTION
U	HARNES-CABLE ASSEMBLY
T	2ED HIGH LIMIT 480 F
S	ELEMENT, FIREBAR 8.5KW
R	ELEMENT, FIREBAR 7KW
N	THERMISTOR PROBE
L	RELAY, TYCO T92S11 DPDT 24V COIL
K	NCC TEMPERATURE CONTROL
G	RELAY, DPDT 24V COIL
D1	ROCKER SWITCH ASSEMBLY- START
D	ROCKER SWITCH ASSEMBLY
C	CONTACTOR 3P 50A 230V COIL
A	TERMINAL BLOCK

WIRING DIA. 208 & 240 V. NCC ANALOG CONTROL

17 & 14 KW. SLAVE SOLID STATE SWITCHING

DERIVED FROM 00959348-3 Rev C Refer to Schmatic 957331-2

A15001

Fig. 50

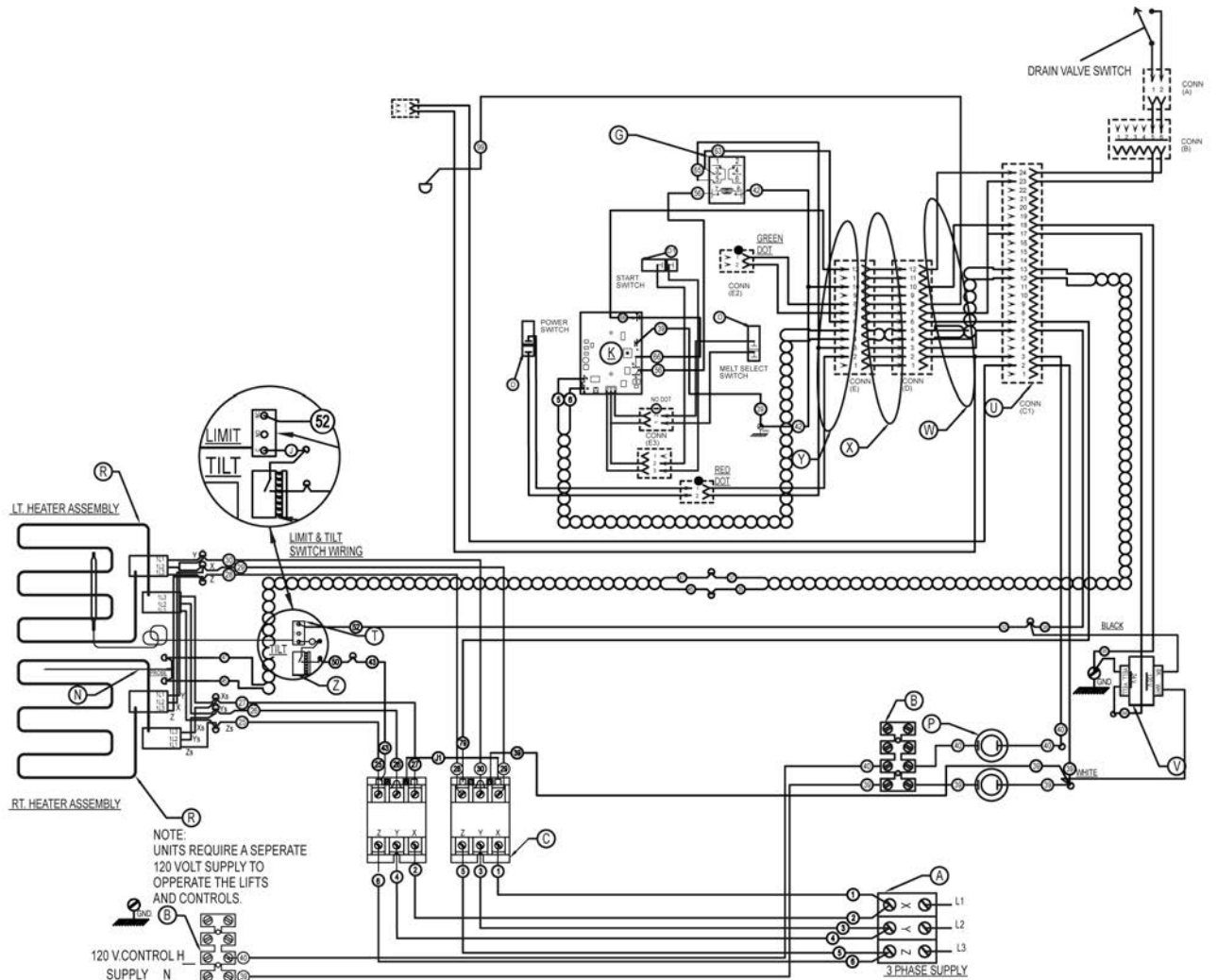

NOTE:
UNITS REQUIRE A SEPARATE
120 VOLT SUPPLY TO
OPERATE THE LIFTS
AND CONTROLS.

120 V CONTROL H
SUPPLY N

480 VOLT PHASE LOAD

TOTAL KW	KW/PHASE		
	X-Y	X-Z	Y-Z
24	8	8	8
17	5.66	5.66	5.66
14	4.66	4.66	4.66
AMPS PER LINE			
	X	Y	Z
24	29	29	29
17	20	20	20
14	17	17	17

Z	SWITCH, LIMIT
Y	HARNES-CONTROL BOX
X	HARNES-POWER TO CONTROL BOX
V	TRANSFORMER 40 VA. 240V./24V.
W	HARNES-POWER DISTRIBUTION
U	HARNES-CABLE ASSEMBLY
T	2ED HIGH LIMIT 480 F
S	ELEMENT, FIREBAR 8.5KW
R3	ELEMENT, FIREBAR 480V. 12KW
R3	ELEMENT, FIREBAR 480V. 10.5KW
R2	ELEMENT, FIREBAR 480V. 8.5KW
R1	ELEMENT, FIREBAR 480V. 7KW.
P	FUSE & HOLDER
N	THERMISTOR PROBE
N	THERMISTOR PROBE
K	NCC TEMPERATURE CONTROL
G	RELAY, DPDT 24V COIL
D1	ROCKER SWITCH ASSEMBLY- START
D	ROCKER SWITCH ASSEMBLY
C	CONTACTOR 3P 50A 230V COIL
B	STRIP-TERMINAL BARRIER
A	TERMINAL BLOCK

WIRING DIA. 480V NCC ANALOG CONTROL
 24,21.17 & 14KW. STAND ALONE W SS SWITCHING
 DERIVED FROM 00959349-1 Rev B Refer to Schematic 957332-1

AI5003

Fig. 51

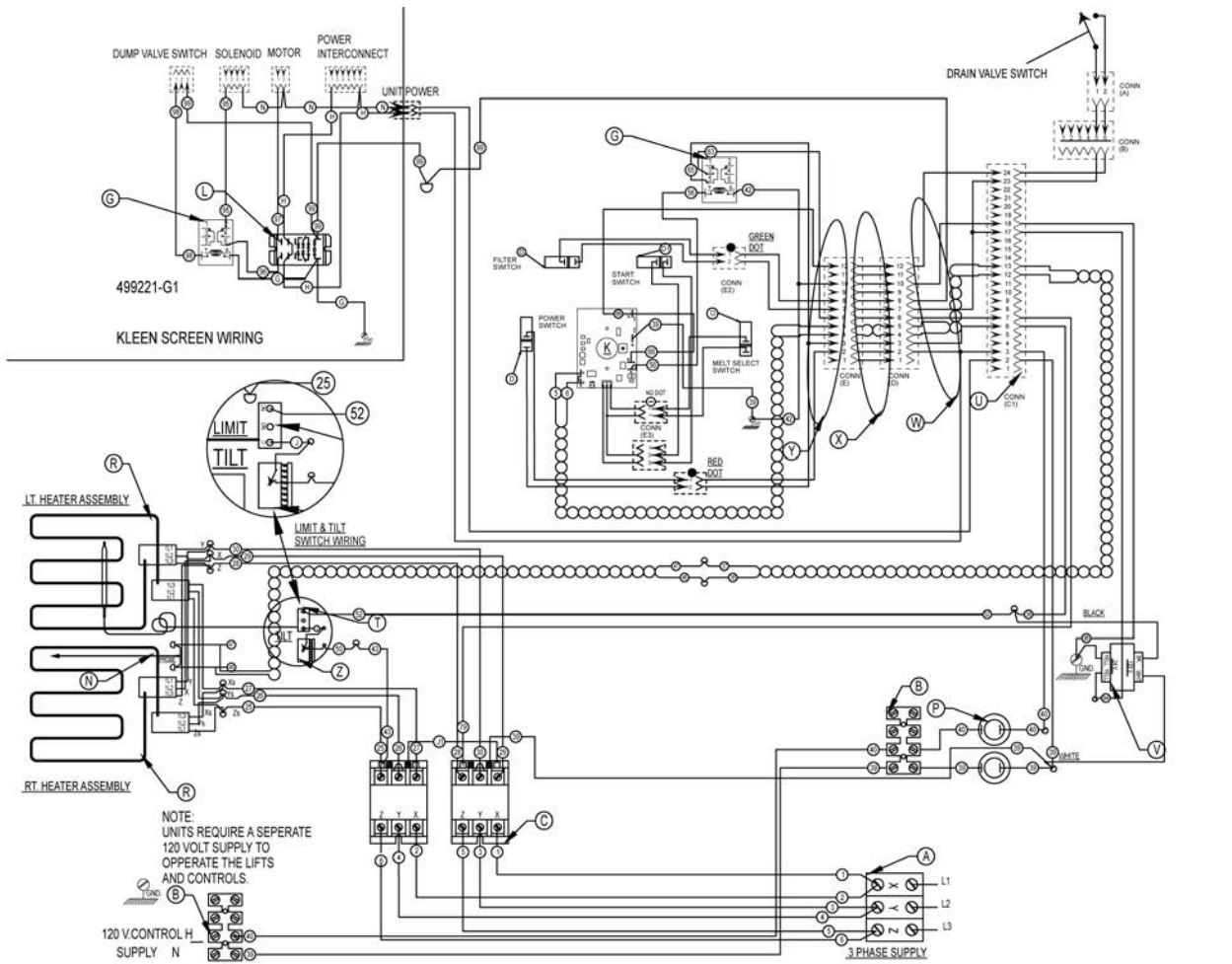

480 VOLT PHASE LOAD

TOTAL KW	KW/PHASE		
	X-Y	X-Z	Y-Z
24	8	8	8
17	5.66	5.66	5.66
14	4.66	4.66	4.66
AMPS PER LINE			
	X	Y	Z
24	29	29	29
17	20	20	20
14	17	17	17

Z	SWITCH, LIMIT
Y	HARNESS-CONTROL BOX
X	HARNESS-POWER TO CONTROL BOX
W	HARNESS-POWER DISTRIBUTION
V	TRANSFORMER 40 VA. 240V./24V.
U	HARNESS-CABLE ASSEMBLY
T	2ED HIGH LIMIT 460 F
R3	ELEMENT, FIREBAR 480V 12 KW.
R3	ELEMENT, FIRBAR 480V 10.5 KW.
R2	ELEMENT, FIRBAR 480V 8.5 KW.
R1	ELEMENT, FIRBAR 480V 7 KW.
P	FUSE & HOLDER
N	THERMISTOR PROBE
N	THERMISTOR PROBE
L	RELAY, TYCO T92S11 DPDT 24V COIL
K	NCC TEMPERATURE CONTROL
H	RELAY, DPDT 120V COIL
G	RELAY, DPDT 24V COIL
D1	ROCKER SWITCH ASSEMBLY- START
D	ROCKER SWITCH ASSEMBLY
C	CONTACTOR 3P 50A 230V COIL
B	STRIP-TERMINAL BARRIER
A	TERMINAL BLOCK

24.21.17 & 14KW. MASTER W SS SWITCHING

WIRING DIA. 480V NCC ANALOG CONTROL

DERIVED FROM 0959349-2 Rev B Refer to Schematic 957332-2

AI5002

Fig. 52

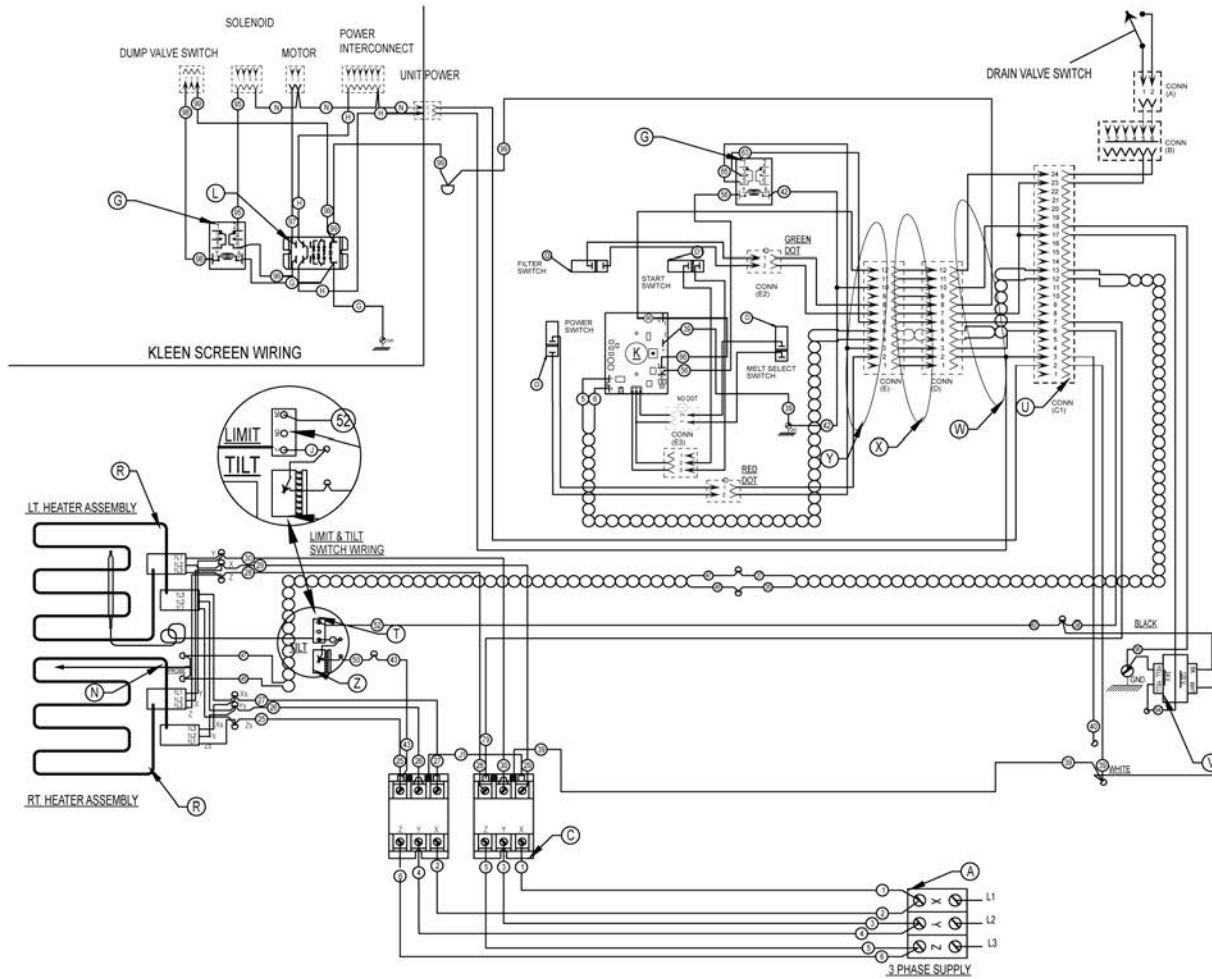

480 VOLT PHASE LOAD

TOTAL KW	KW/PHASE		
	X-Y	X-Z	Y-Z
24	8	8	8
17	5.66	5.66	5.66
14	4.66	4.66	4.66
AMPS PER LINE			
	X	Y	Z
24	29	29	29
17	20	20	20
14	17	17	17

24,21,17 & 14KW. SLAVE W SS SWITCHING
 WIRING DIA. 480V NCC ANALOG CONTROL

DERIVED FROM 00959349-3 Rev B Refer to Schematic 957332-2

Z	SWITCH, LIMIT
Y	HARNES-CONTROL BOX
X	HARNES-POWER TO CONTROL BOX
V	TRANSFORMER 40 VA. 240V./24V.
W	HARNES-POWER DISTRIBUTION
U	HARNES-CABLE ASSEMBLY
T	2ED HIGH LIMIT 460 F
R3	ELEMENT, FIREBAR 480V. 12KW
R3	ELEMENT, FIREBAR 480V. 10.5KW
R2	ELEMENT, FIREBAR 480V. 8.5KW
R1	ELEMENT, FIREBAR 480V. 7KW.
N	THERMISTOR PROBE
N	THERMISTOR PROBE
K	NCC TEMPERATURE CONTROL
L	RELY, TYCO T92S11 DPDT 24V COIL
H	RELY, DPDT 120V.
G	RELY, DPDT 24V COIL
D1	ROCKER SWITCH ASSEMBLY- START
D	ROCKER SWITCH ASSEMBLY
C	CONTACTOR 3P 50A 230V COIL
A	TERMINAL BLOCK

AI5006

Fig. 53

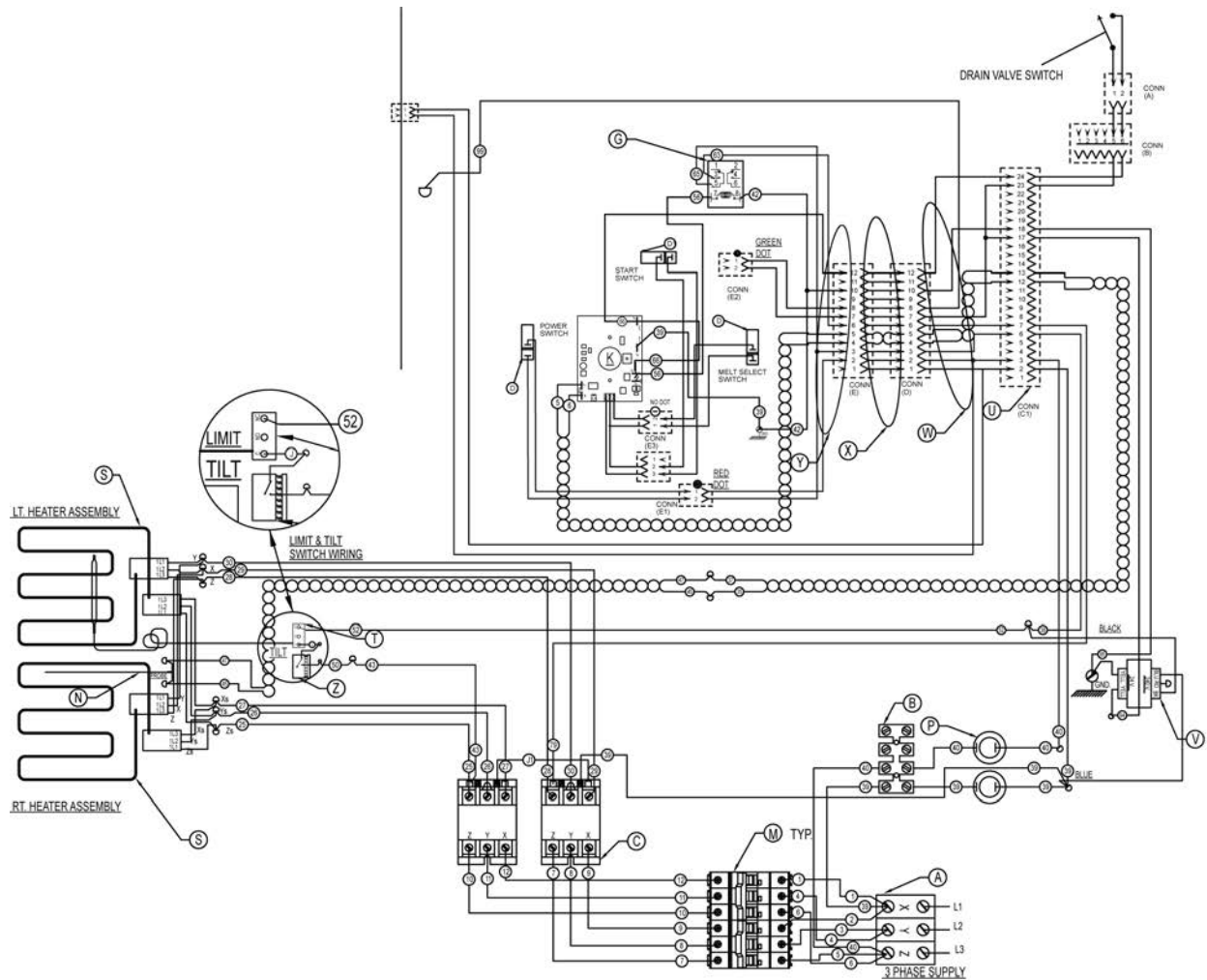

208-240 VOLT PHASE LOAD

TOTAL KW	KW/PHASE		
	X-Y	X-Z	Y-Z
24	8	8	8
AMPS PER LINE 208 VOLT			
	X	Y	Z
24	67	67	67
AMPS PER LINE 240 VOLT			
	X	Y	Z
24	58	58	58

Z	SWITCH, LIMIT
Y	HARNESS-CONTROL BOX
X	HARNESS-POWER TO CONTROL BOX
V	TRANSFORMER 40 VA. 240V./24V.
W	HARNESS-POWER DISTRIBUTION
U	HARNESS-CABLE ASSEMBLY
T	2ED HIGH LIMIT 460 F
S	ELEMENT, FIREBAR 12KW
P	FUSE & HOLDER
N	THERMISTOR PROBE
M	CIRCUIT BREAKER 50A 3 POLE
K	NCC TEMPERATURE CONTROL
G	RELAY, DPDT 24V COIL
F1	FILTER ASSEMBLY SINGLE
D1	ROCKER SWITCH ASSEMBLY- START
D	ROCKER SWITCH ASSEMBLY
C	CONTACTOR 3P 50A 230V COIL
B	STRIP-TERMINAL BLOCK
A	TERMINAL BLOCK

WIRING DIA. 208 & 240 VOLT ANALOG

24 KW. STAND ALONE WITH SOLID STATE SWITHING

DERIVED FROM 00959347-1 Rev B Refer to Schematic 957332-1

A15007

Fig. 54

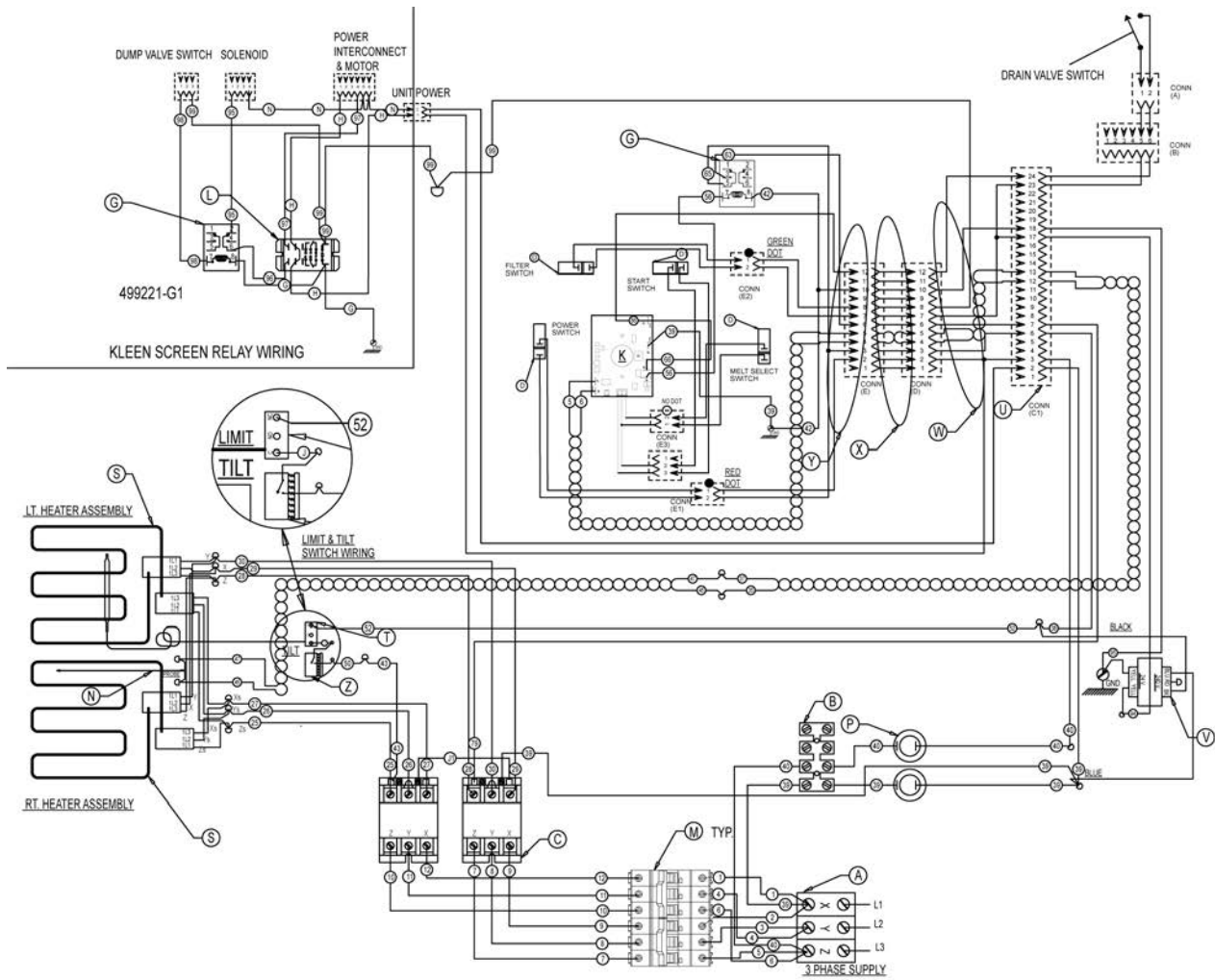

208-240 VOLT PHASE LOAD

TOTAL KW	KW/PHASE		
	X-Y	X-Z	Y-Z
24	8	8	8
AMPS PER LINE 208 VOLT			
24	67	67	67
AMPS PER LINE 240 VOLT			
24	58	58	58

WIRING DIA. 208 & 240 V. NCC ANALOG CONTROL

24 KW. MASTER WITH SOLID STATE SWITCHING

DERIVED FROM 00959347-2 Rev B Refer to Schematic 957331-2

Z	SWITCH, LIMIT
Y	HARNES-CONTROL BOX
X	HARNES-POWER TO CONTROL BOX
W	HARNES-POWER DISTRIBUTION
V	TRANSFORMER 40 VA. 240V./24V.
U	HARNES-CABLE ASSEMBLY
T	2ED HIGH LIMIT 460 F
S	ELEMENT, FIREBAR 12KW
P	FUSE & HOLDER
N	THERMISTOR PROBE
M	CIRCUIT BREAKER 50A 3 POLE
L	RELAY, TYCO T92S11 DPDT 24V COIL
K	NCC TEMPERATURE CONTROL
G	RELAY, DPDT 24V COIL
D1	ROCKER SWITCH ASSEMBLY- START
D	ROCKER SWITCH ASSEMBLY
C	CONTACTOR 3P 50A 230V COIL
B	STRIP-TERMINAL BARRIER
A	TERMINAL BLOCK

A15004

Fig. 55

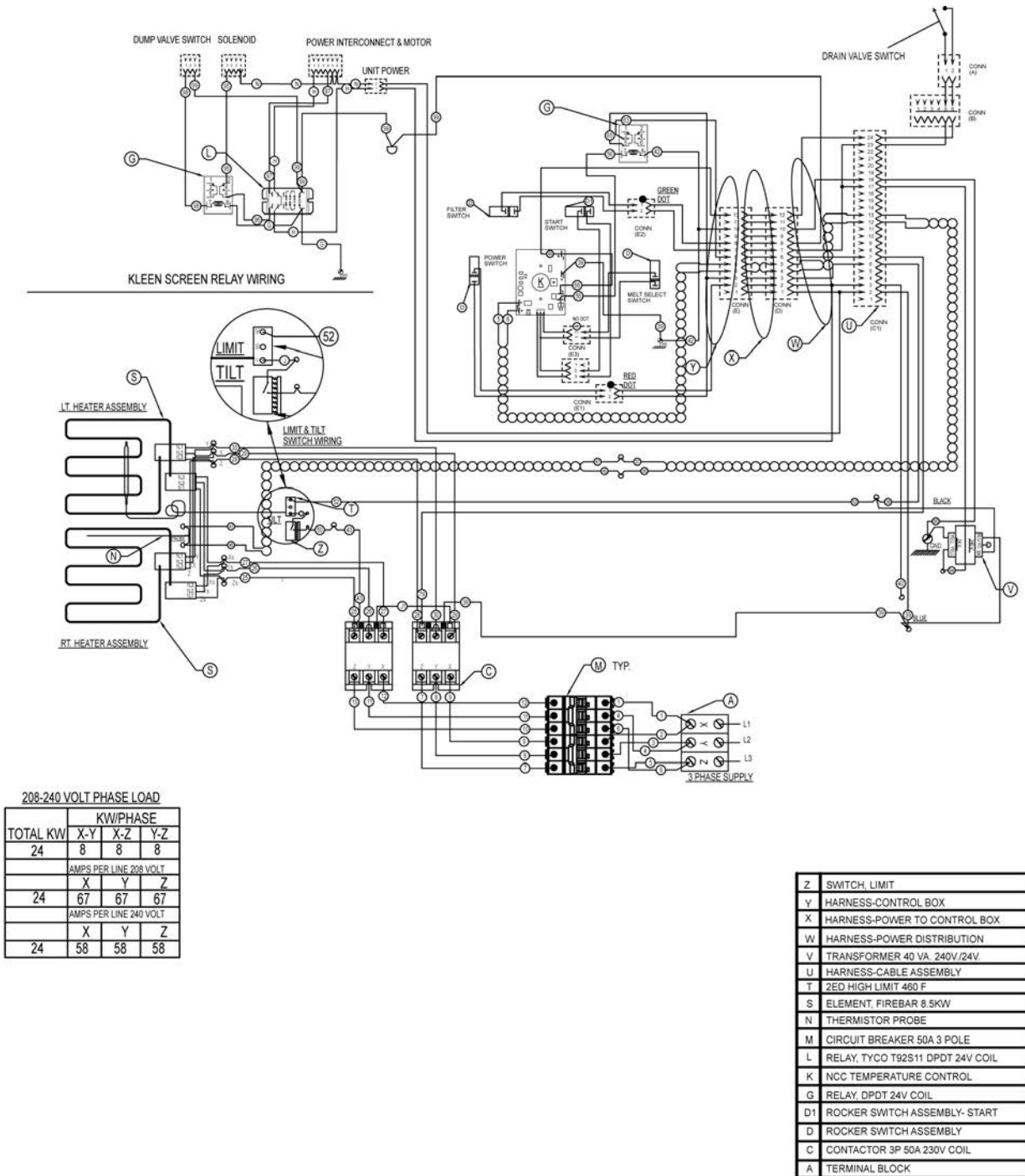

DERIVED FROM 00959347-3 Rev B Refer to Schematic 957331-2

AI5005

Fig. 56

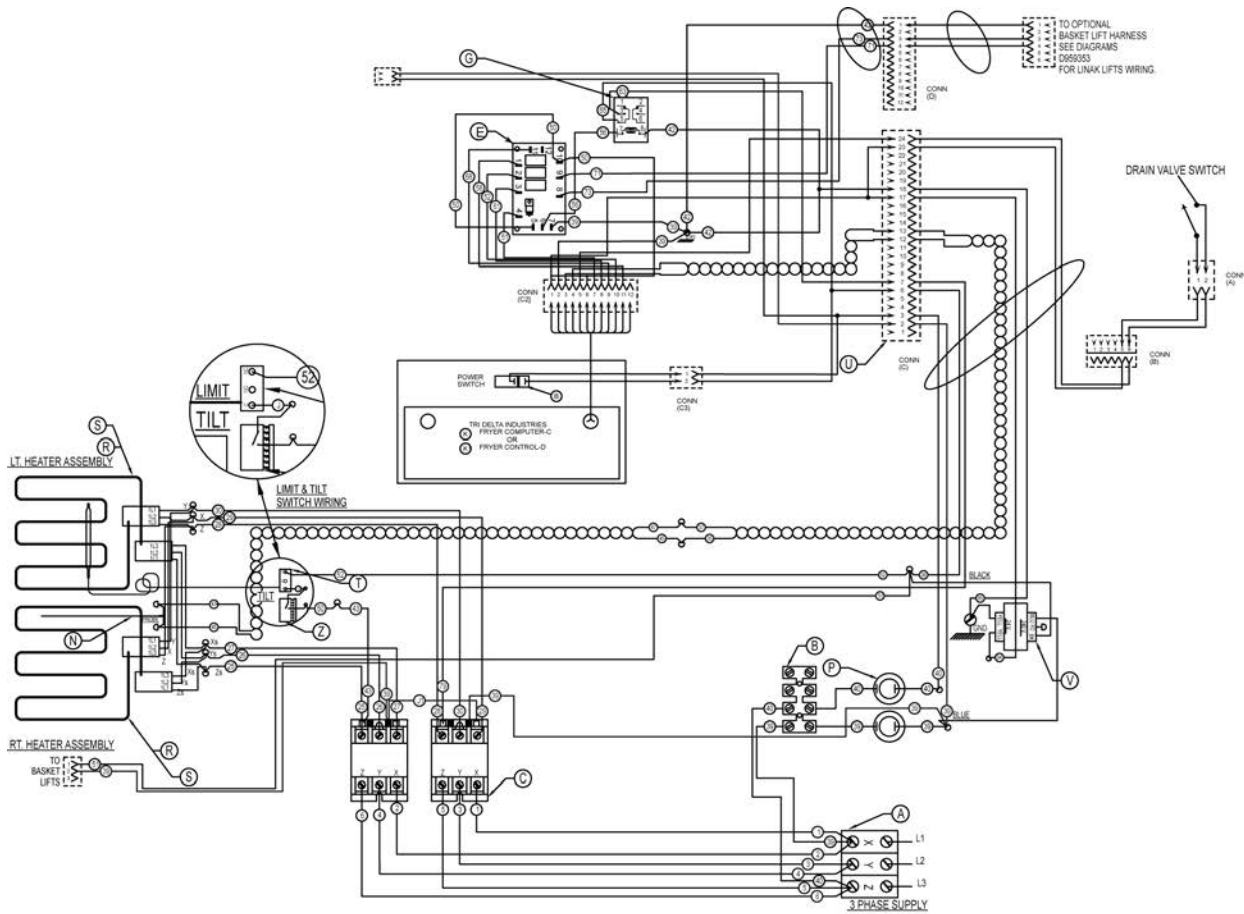

208-240 VOLT PHASE LOAD

TOTAL KW	KW/PHASE		
	X-Y	X-Z	Y-Z
17	5.6	5.6	5.6
14	4.6	4.6	4.6
AMPS PER LINE 208 VOLT			
	X	Y	Z
17	47	47	47
14	39	39	39
AMPS PER LINE 240 VOLT			
	X	Y	Z
17	41	41	41
14	34	34	34

WIRING DIA. 208 & 240 VOLT NCC CONTROL

17 & 14 KW. FULL-VAT FRYERS STAND ALONE

Z	SWITCH, LIMIT
V	TRANSFORMER 40 VA. 240V./24V.
U	HARNES-CABLE ASSEMBLY
T	2ED HIGH LIMIT 480 F
S	ELEMENT, FIREBAR 8.5KW
R	ELEMENT, FIREBAR 7KW
P	FUSE & HOLDER
N	THERMISTOR PROBE
K1	NCC CONTROL W / TIMER(S)
K	NCC TEMPERATURE CONTROL
G	RELAY, DPDT 24V COIL
E	CONTROL, INTERFACE TRIDELTA
D	ROCKER SWITCH ASSEMBLY
C	CONTACTOR 3P 50A 230V COIL
B	STRIP-TERMINAL BARRIER
A	TERMINAL BLOCK

DERIVED FROM 00959322-1 Rev B Refer to Schematic 428281-1

AI5014

Fig. 57

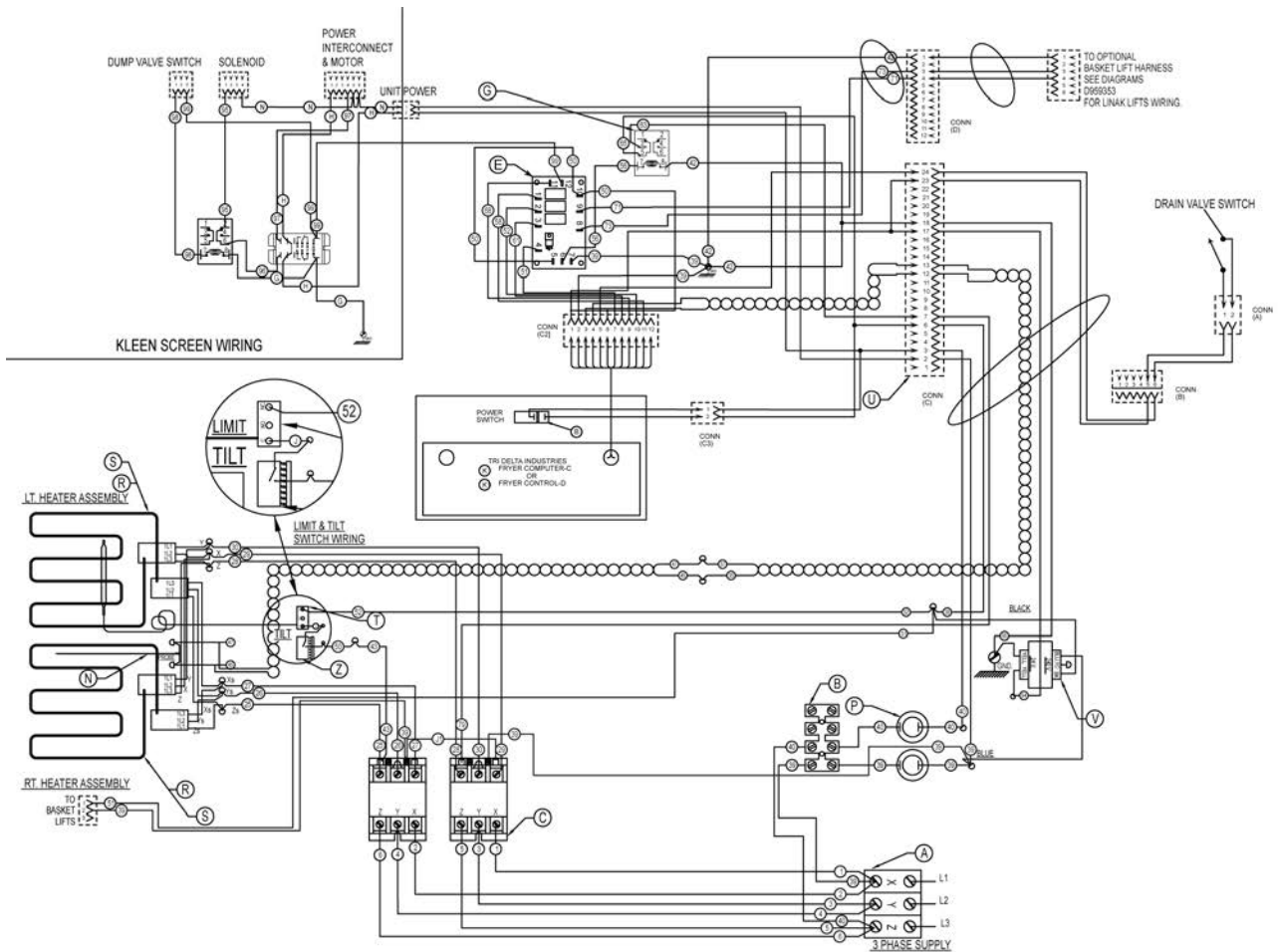

208-240 VOLT PHASE LOAD

TOTAL KW	KW/PHASE		
	X	Y	Z
17	5.6	5.6	5.6
14	4.6	4.6	4.6
AMPS PER LINE 208 VOLT			
	X	Y	Z
17	47	47	47
14	39	39	39
AMPS PER LINE 240 VOLT			
	X	Y	Z
17	41	41	41
14	34	34	34

Z	SWITCH, LIMIT
Y	HARNESS-CONTROL BOX
V	TRANSFORMER 40 VA. 240V./24V.
U	HARNESS-CABLE ASSEMBLY
T	2ED HIGH LIMIT 460 F
S	ELEMENT, FIREBAR 12KW
R	ELEMENT, FIREBAR 7KW
P	FUSE & HOLDER
N	THERMISTOR PROBE
K1	NCC CONTROL W/TIMER(S)
K	NCC COMPUTER
G	RELAY, DPDT 24V COIL
E	CONTROL, INTERFACE TRIDELTA
D	ROCKER SWITCH ASSEMBLY
C	CONTACTOR 3P 50A 230V COIL
B	STRIP-TERMINAL BARRIER
A	TERMINAL BLOCK

WIRING DIA. 208 & 240 VOLT DIGITAL
17 & 14 KW. MASTER SOLID STATE SWITCHING

DERIVED FROM 00959322-2 Rev B Refer to Schematic 428281-1

AI5015

Fig. 58

ERA / EBD ELECTRIC FRYER - ELECTRICAL OPERATION

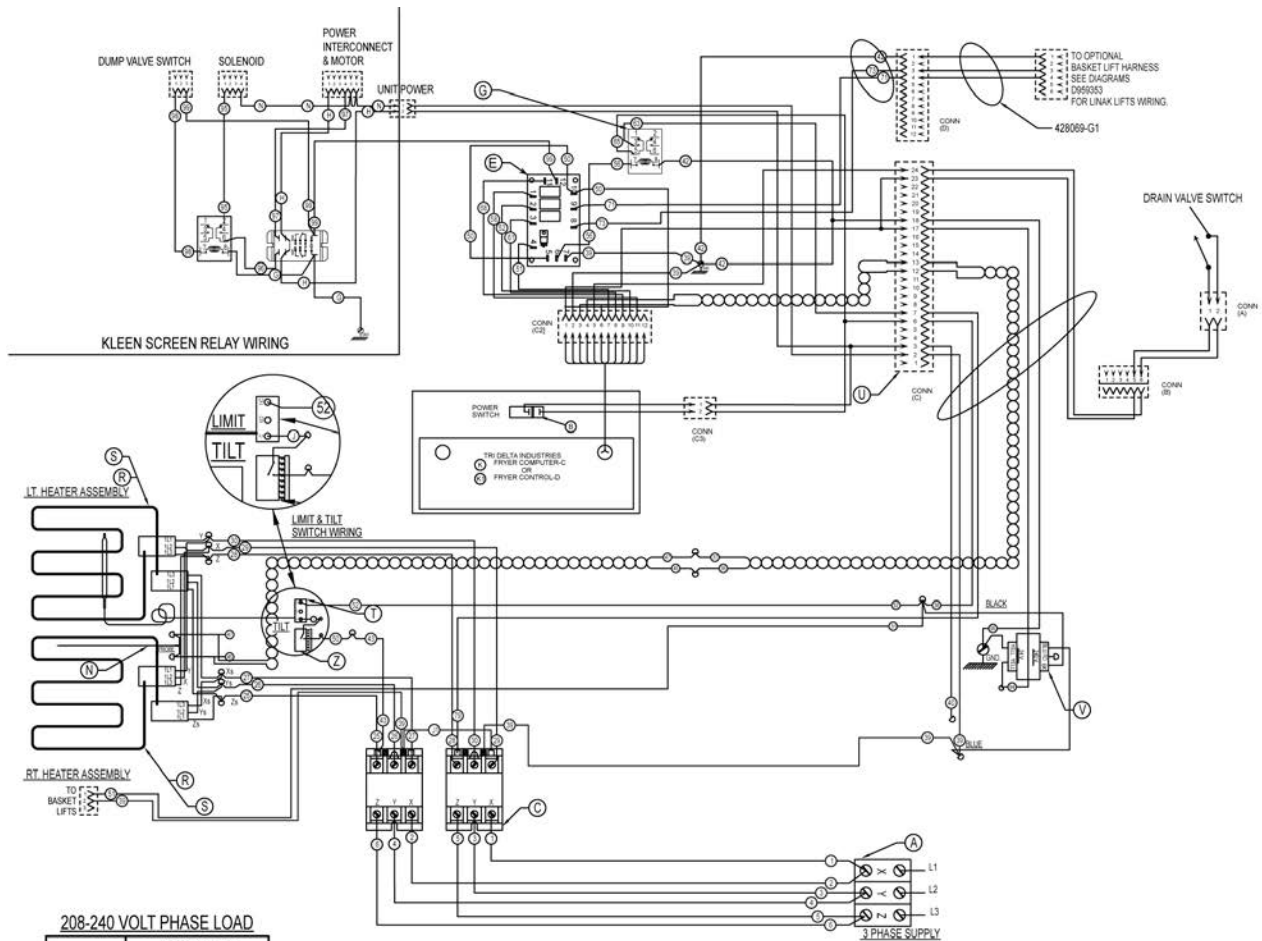

208-240 VOLT PHASE LOAD

TOTAL KW	KW/PHASE		
	X-Y	X-Z	Y-Z
17	5.6	5.6	5.6
14	4.6	4.6	4.6
AMPS PER LINE 208 VOLT			
	X	Y	Z
17	47	47	47
14	39	39	39
AMPS PER LINE 240 VOLT			
	X	Y	Z
17	41	41	41
14	34	34	34

Z	SWITCH, LIMIT
V	TRANSFORMER 40 VA. 240V./24V.
U	HARNESS-CABLE ASSEMBLY
T	2ED HIGH LIMIT 460 F
S	ELEMENT, FIREBAR 12KW
R	ELEMENT, FIREBAR 7KW
N	THERMISTOR PROBE
K1	NCC CONTROL W/TIMER(S)
K	NCC COMPUTER
G	RELAY, DPDT 24V COIL
E	CONTROL, INTERFACE TRIDELTA
D	ROCKER SWITCH ASSEMBLY
C	CONTACTOR 3P 50A 230V COIL
A	TERMINAL BLOCK

WIRING DIA. 208 & 240 VOLT DIGITAL

17 & 14 KW. SLAVE SOLID STATE SWITCHING

DERIVED FROM 00959322-3 Rev B Refer to Schematic 428281-1

AI5016

Fig. 59

TROUBLESHOOTING

ALL MODELS

SYMPTOMS	POSSIBLE CAUSES
Fryer does not heat, but voltage is present between J2 and J9.	<ol style="list-style-type: none"> 1. Tilt switch covered with debris or malfunction (heating elements are lowered). 2. High limit thermostat open. 3. Contactor(s) malfunction. 4. Cooking control malfunction (no output from terminal J5). 5. R1 heat relay malfunction. 6. Interconnecting wiring malfunction.
Fryer does not heat, voltage not present between J2 and J9.	<ol style="list-style-type: none"> 1. Check main power to unit. 2. Internal circuit breaker OFF (24kW, 208-240V units only). 3. Power switch off or malfunction. 4. Transformer inoperative. 5. R2 power relay malfunction. 6. Drain valve switch open or switch malfunction. 7. Interconnecting wiring malfunction.
Excessive time to melt solid shortening (more than 45 minutes).	<ol style="list-style-type: none"> 1. Melt cycle timing incorrect. 2. Incorrect supply voltage. 3. Temperature probe malfunction. 4. Cooking control malfunction.
Excessive or low heat.	<ol style="list-style-type: none"> 1. Incorrect supply voltage. 2. Temperature probe malfunction. 3. Contactor(s) malfunction. 4. R1 heat relay malfunction. 5. Heating element malfunction (low heat). 6. Cooking control malfunction.
Intermittent problems.	<ol style="list-style-type: none"> 1. High ambient temperatures. 2. Wiring connections loose.

FRYMATE (DUMP STATION) WITH OPTIONAL HEATER

SYMPTOMS	POSSIBLE CAUSES
Fryer does not heat, but voltage is present between J2 and J9.	<ol style="list-style-type: none"> 1. Unplugged. 2. Power switch off or inoperative. 3. Main circuit breaker off or open. 4. Malfunctioning heater assembly.

KLEENSCREEN FILTERING SYSTEM

SYMPTOMS	POSSIBLE CAUSES
Shortening not filtering, pump motor is energized.	<ol style="list-style-type: none"> 1. Clog in filter system lines. NOTE: If using solid shortening, when all filtered shortening is returned to the fry tank and filter power switch is off, open the filter drawer approximately one inch. Allow the remaining shortening in the line to drain into the filter tank to prevent possible clogging after the shortening cools and solidifies. Close the filter drawer when complete. 2. Shortening below 300°F to thick. 3. Fill solenoid valve malfunction. 4. Interconnecting wiring malfunction. 5. Pump is inoperative.
Shortening not discarding, pump motor energized.	<ol style="list-style-type: none"> 1. Filter screen plugged. NOTE: If using solid shortening, when all filtered shortening is returned to the fry tank and filter power switch is off, open the filter drawer approximately one inch. Allow the remaining shortening in the line to drain into the filter tank to prevent possible clogging after the shortening cools and solidifies. Close the filter drawer when complete. 2. Clog in filter system lines. 3. Shortening below 300°F to thick. 4. Discard valve switch malfunction (N.O. contacts not closing to energize R3 filter relay coil). NOTE: The fill solenoid valve should not be energized during discard operation so that shortening will flow thru manual discard valve only. 5. R3 fill relay malfunction (contacts remain closed). 6. Discard valve mechanical malfunction. 7. Discard hose connection not fully engaged. 8. Pump is inoperative.

SYMPTOMS	POSSIBLE CAUSES
Pump motor is not energized to circulate shortening thru filtering system.	<ol style="list-style-type: none"> 1. Filter switch on cooking controls not turned on. 2. Pump needs reset. (Reset button located on pump.) 3. R3 filter relay malfunction. 4. Interconnecting wiring malfunction. 5. Pump motor inoperative.
Pump motor is not energized to discard shortening. 1	<ol style="list-style-type: none"> 1. Filter switch on cooking controls not turned on. 2. Pump needs reset. (Reset button located on pump) 3. Discard handle (yellow) not extended. 4. R3 filter relay malfunction. 5. Interconnecting wiring malfunction. 6. Pump motor inoperative.

Z	SWITCH, LIMIT
V	TRANSFORMER, 40 VA 240V/24V.
U	HARNESS-CABLE ASSEMBLY
T	2ED HIGH LIMIT 460 F
S	ELEMENT, FIREBAR 12KW
P	FUSE & HOLDER
N	THERMISTOR PROBE
M	CIRCUIT BREAKER 50A 3 POLE
K1	NCC CONTROL W/TIMER(S)
K	NCC COMPUTER
G	RELAY, DPDT 24V COIL
E	CONTROL, INTERFACE TRIDELTA
D	ROCKER SWITCH ASSEMBLY
C	CONTACTOR 3P 50A 230V COIL
B	STRIP-TERMINAL BARRIER
A	TERMINAL BLOCK

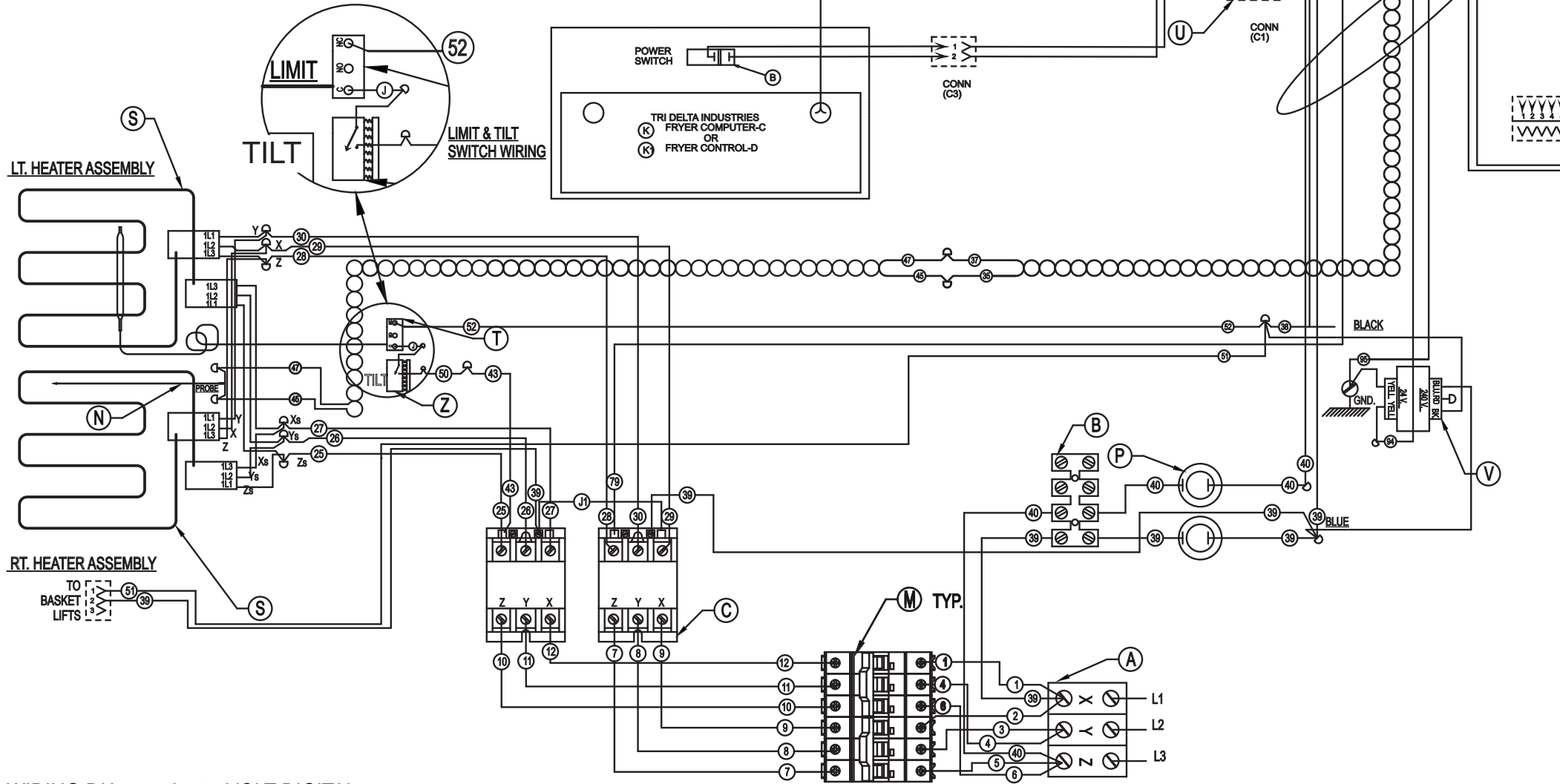

TO OPTIONAL BASKET LIFT HARNESS SEE DIAGRAMS D959353 FOR LINAK LIFTS WIRING.

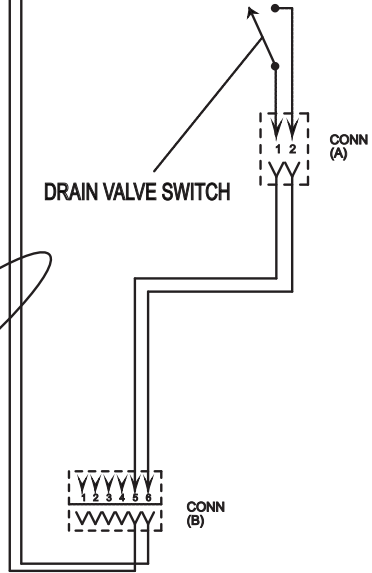
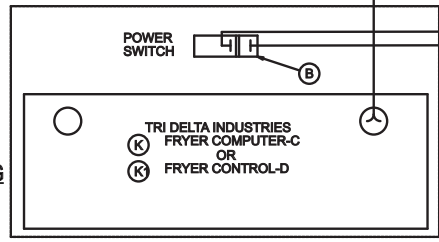
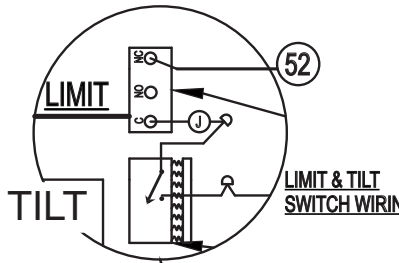

208-240 VOLT PHASE LOAD

TOTAL KW	KW/PHASE		
	X-Y	X-Z	Y-Z
24	8	8	8
AMPS PER LINE 208 VOLT			
	X	Y	Z
24	67	67	67
AMPS PER LINE 240 VOLT			
	X	Y	Z
24	58	58	58

WIRING DIA. 208 & 240 VOLT DIGITAL
 24 KW. STAND ALONE SOLID STATE SWITCHING
 3 PHASE SUPPLY

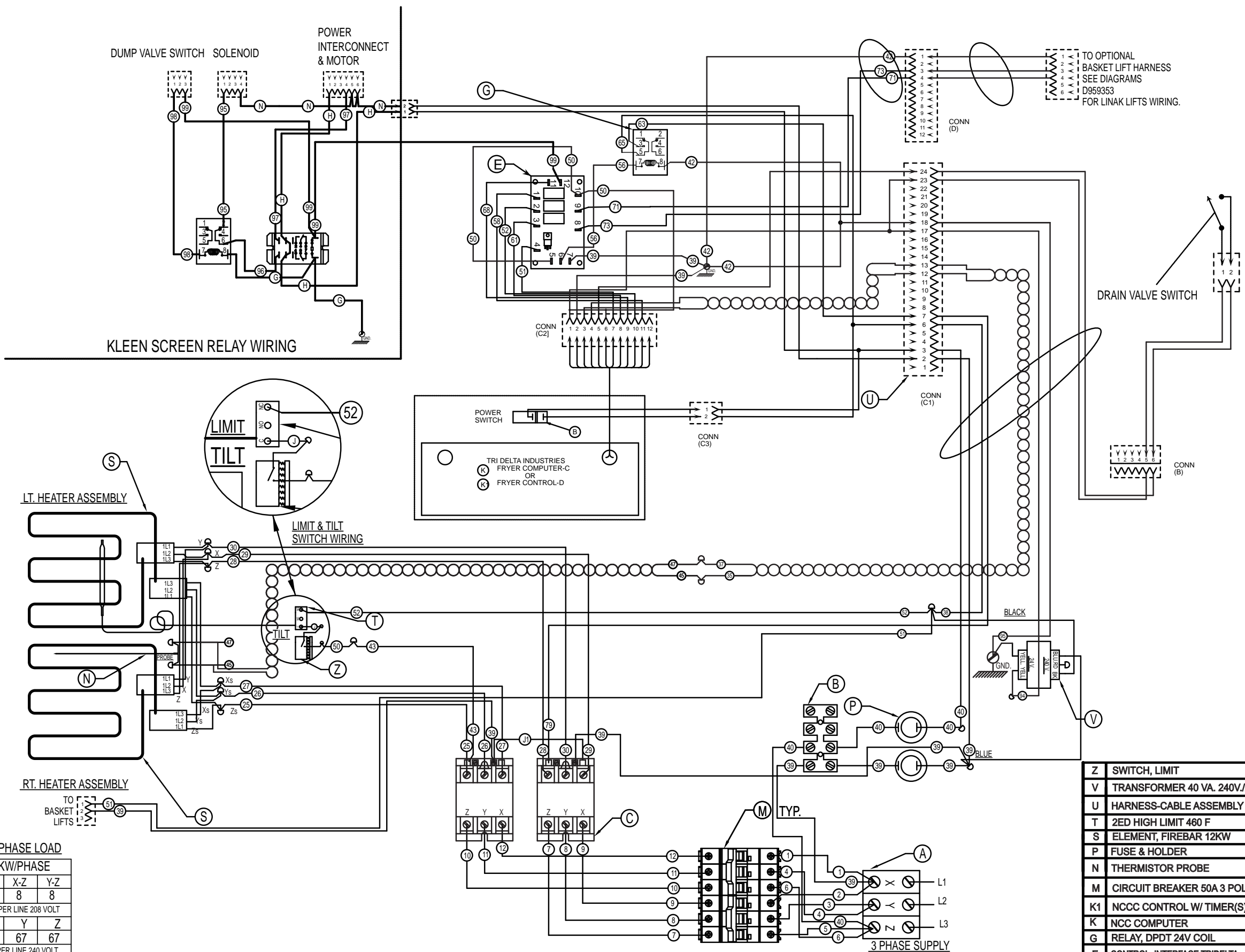

TO OPTIONAL BASKET LIFT HARNESS SEE DIAGRAMS D959353 FOR LINAK LIFTS WIRING.

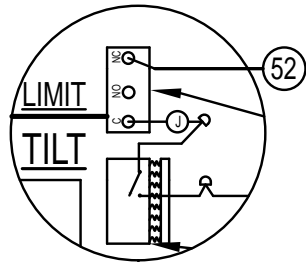

208-240 VOLT PHASE LOAD

TOTAL KW	KW/PHASE		
	X-Y	X-Z	Y-Z
24	8	8	8
AMPS PER LINE 208 VOLT			
	X	Y	Z
24	67	67	67
AMPS PER LINE 240 VOLT			
	X	Y	Z
24	58	58	58

Z	SWITCH, LIMIT
V	TRANSFORMER 40 VA. 240V/24V.
U	HARNES-CABLE ASSEMBLY
T	2ED HIGH LIMIT 460 F
S	ELEMENT, FIREBAR 12KW
P	FUSE & HOLDER
N	THERMISTOR PROBE
M	CIRCUIT BREAKER 50A 3 POLE
K1	NCCC CONTROL W/ TIMER(S)
K	NCC COMPUTER
G	RELAY, DPDT 24V COIL
E	CONTROL, INTERFACE TRIDELTA
D1	ROCKER SWITCH ASSEMBLY- START
D	ROCKER SWITCH ASSEMBLY
C	CONTACTOR 3P 50A 230V COIL
B	STRIP-TERMINAL BLOCK
A	TERMINAL BLOCK

WIRING DIA. 208 & 240 VOLT DIGITAL
24 KW. MASTER SOLID STATE SWITCHING

DERIVED FROM 00959321-2 Rev B Refer to Schematic 428281-1

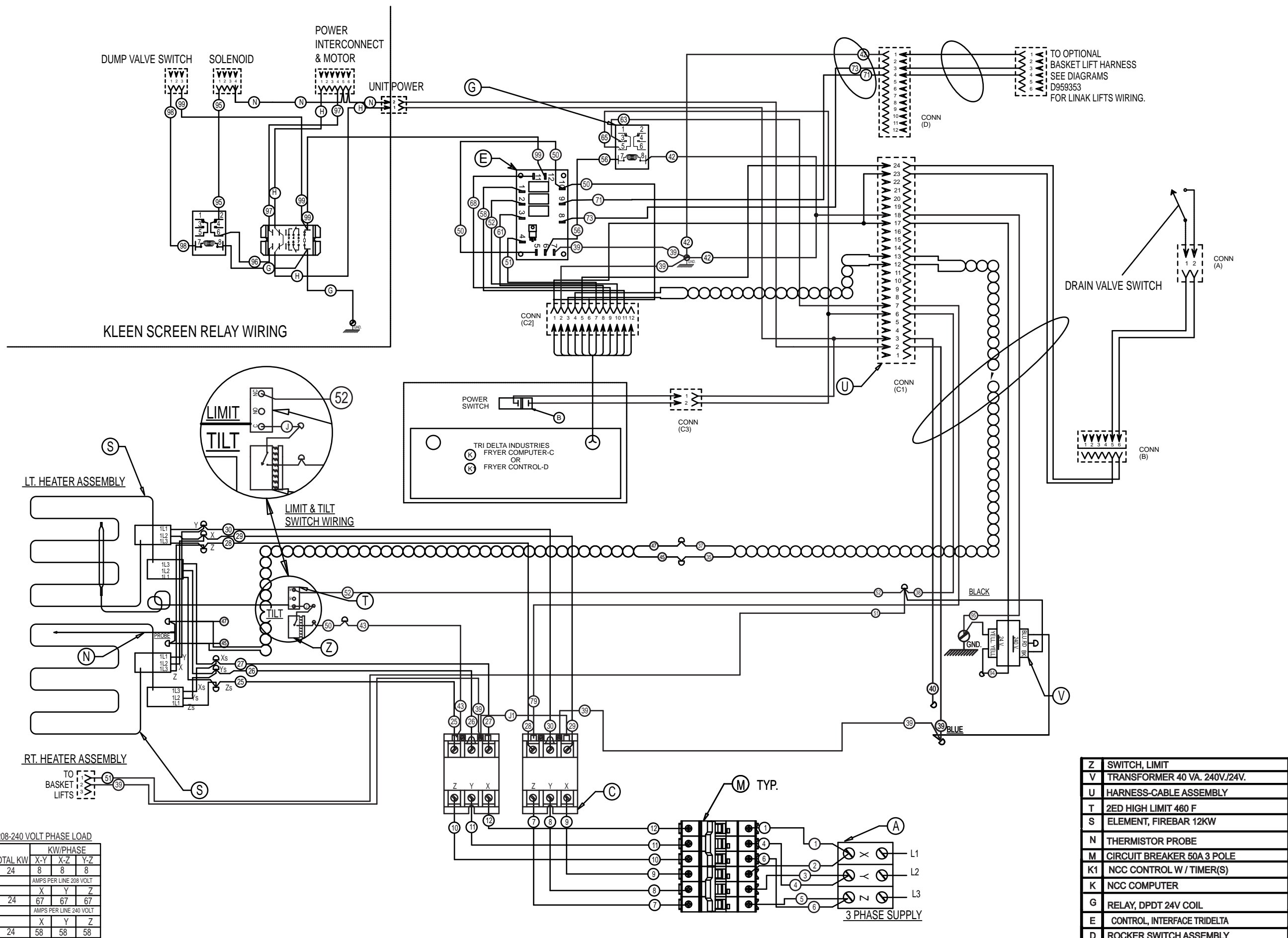

WIRING DIA. 208 & 240 VOLT DIGITAL

24 KW. SLAVE SOLID STATE SWITCHING

DERIVED FROM 00959321-3 Rev B Refer to Schematic 428281-1

Z	SWITCH, LIMIT
Y	HARNESS-CONTROL BOX
X	HARNESS-POWER TO CONTROL BOX
V	TRANSFORMER 40 VA. 240V./24V.
W	HARNESS-POWER DISTRIBUTION
U	HARNESS-CABLE ASSEMBLY
T	2ED HIGH LIMIT 460 F
S	ELEMENT, FIREBAR 8.5KW
R	ELEMENT, FIREBAR 7KW
P	FUSE & HOLDER
N	THERMISTOR PROBE
K	NCC TEMPERATURE CONTROL
G	RELAY, DPDT 24V COIL
D1	ROCKER SWITCH ASSEMBLY- START
D	ROCKER SWITCH ASSEMBLY
C	CONTACTOR 3P 50A 230V COIL
B	STRIP-TERMINAL BARRIER
A	TERMINAL BLOCK

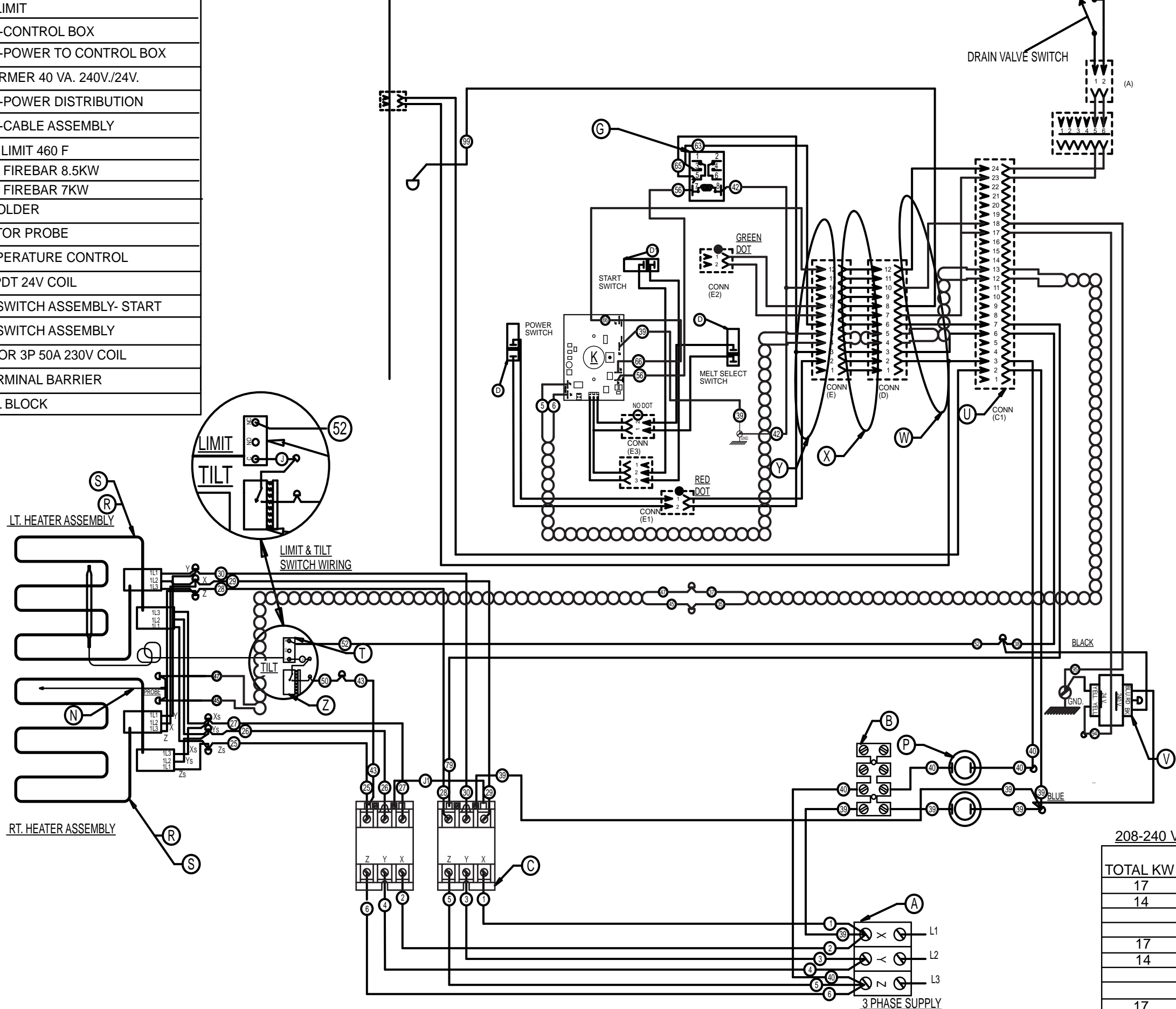

208-240 VOLT PHASE LOAD

TOTAL KW	KW/PHASE		
	X-Y	X-Z	Y-Z
17	5.6	5.6	5.6
14	4.6	4.6	4.6
AMPS PER LINE 208 VOLT			
	X	Y	Z
17	47	47	47
14	39	39	39
AMPS PER LINE 240 VOLT			
	X	Y	Z
17	41	41	41
14	34	34	34

WIRING DIA. 208 & 240 V. NCC ANALOG CONTROL
 17 & 14 KW. STAND ALONE W SOLID STATE SWITCH
 DERIVED FROM 00959348-1 Rev C Refer to Schematic 957331-1

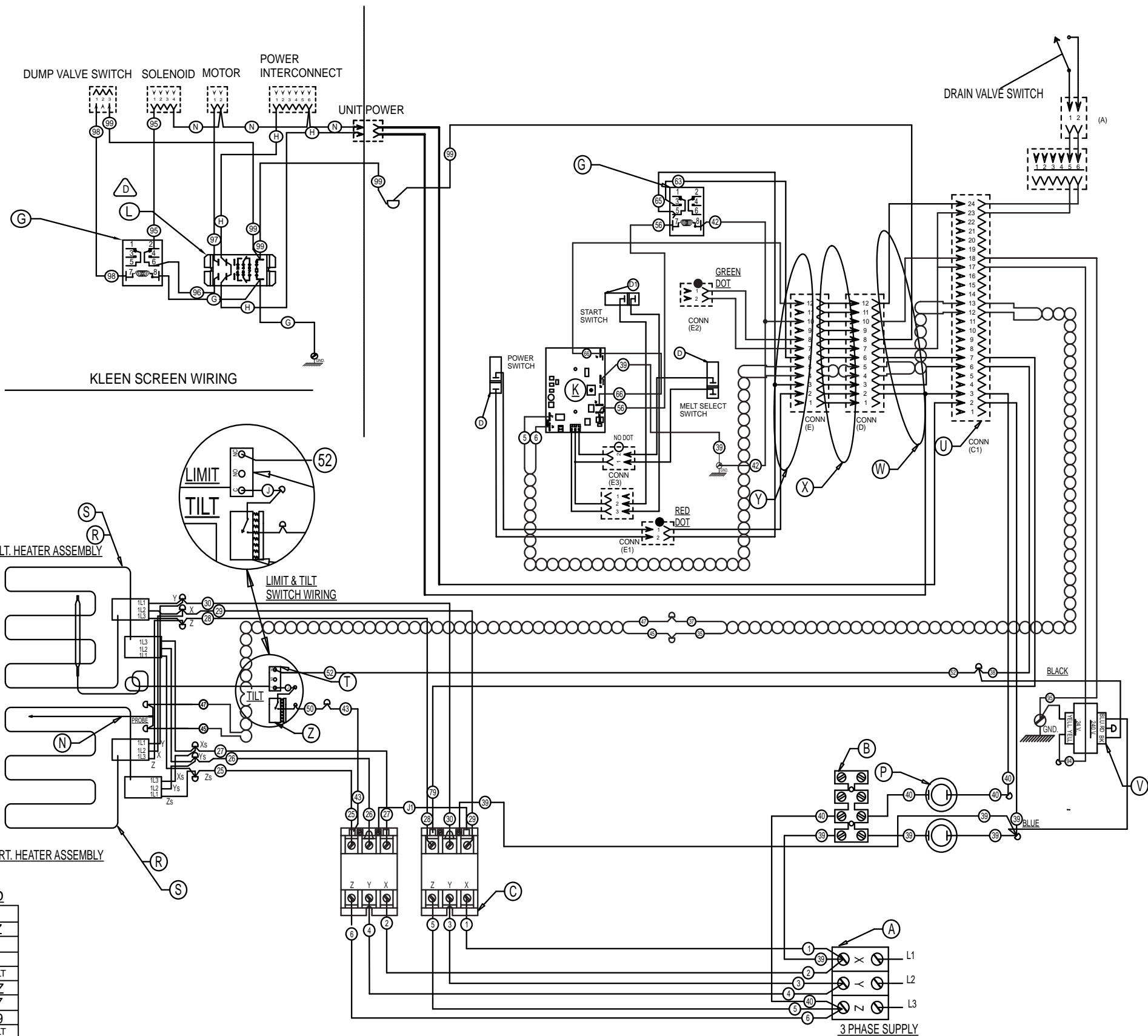

208-240 VOLT PHASE LOAD

TOTAL KW	KW/PHASE		
	X-Y	X-Z	Y-Z
17	5.6	5.6	5.6
14	4.6	4.6	4.6
AMPS PER LINE 208 VOLT			
	X	Y	Z
17	47	47	47
14	39	39	39
AMPS PER LINE 240 VOLT			
	X	Y	Z
17	41	41	41
14	34	34	34

Z	SWITCH, LIMIT
Y	HARNESS-CONTROL BOX
X	HARNESS-POWER TO CONTROL BOX
V	TRANSFORMER 40 VA. 240V./24V.
W	HARNESS-POWER DISTRIBUTION
U	HARNESS-CABLE ASSEMBLY
T	2ED HIGH LIMIT 460 F
S	ELEMENT, FIREBAR 8.5KW
R	ELEMENT, FIREBAR 7KW
P	FUSE & HOLDER
N	THERMISTOR PROBE
L	RELAY, TYCO T92S11 DPDT 24V COIL
K	NCC TEMPERATURE CONTROL
G	RELAY, DPDT 24V COIL
D1	ROCKER SWITCH ASSEMBLY- START
D	ROCKER SWITCH ASSEMBLY
C	CONTACTOR 3P 50A 230V COIL
B	STRIP-TERMINAL BARRIER
A	TERMINAL BLOCK

WIRING DIA. 208 & 240 V. NCC ANALOG CONTROL

17 & 14 KW. STAND ALONE W SOLID STATE SWITCH

DERIVED FROM 00959348-2 Rev C Refer to Schematic 957331-2

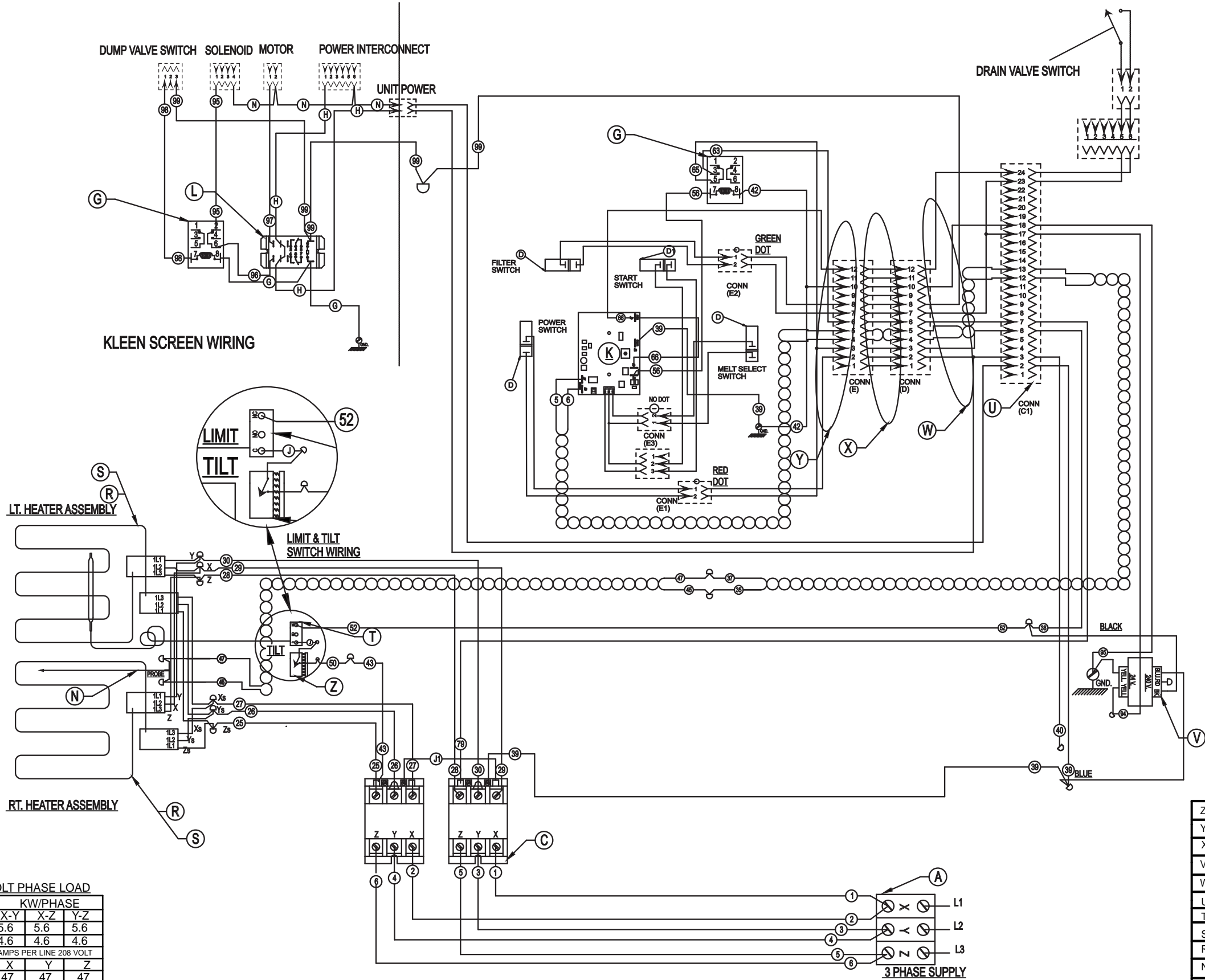

DUMP VALVE SWITCH SOLENOID MOTOR POWER INTERCONNECT

DRAIN VALVE SWITCH

KLEEN SCREEN WIRING

LT. HEATER ASSEMBLY

RT. HEATER ASSEMBLY

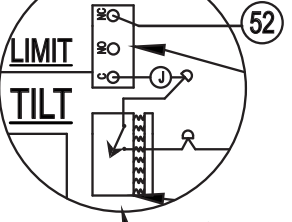

LIMIT & TILT SWITCH WIRING

208-240 VOLT PHASE LOAD			
TOTAL KW	KW/PHASE		
	X-Y	X-Z	Y-Z
17	5.6	5.6	5.6
14	4.6	4.6	4.6
AMPS PER LINE 208 VOLT			
	X	Y	Z
17	47	47	47
14	39	39	39
AMPS PER LINE 240 VOLT			
	X	Y	Z
17	41	41	41
14	34	34	34

Z	SWITCH, LIMIT
Y	HARNESS-CONTROL BOX
X	HARNESS-POWER TO CONTROL BOX
V	TRANSFORMER 40 VA. 240V./24V.
W	HARNESS-POWER DISTRIBUTION
U	HARNESS-CABLE ASSEMBLY
T	2ED HIGH LIMIT 460 F
S	ELEMENT, FIREBAR 8.5KW
R	ELEMENT, FIREBAR 7KW
N	THERMISTOR PROBE
L	RELAY, TYCO T92S11 DPDT 24V COIL
K	NCC TEMPERATURE CONTROL
G	RELAY, DPDT 24V COIL
D1	ROCKER SWITCH ASSEMBLY- START
D	ROCKER SWITCH ASSEMBLY
C	CONTACTOR 3P 50A 230V COIL
A	TERMINAL BLOCK

WIRING DIA. 208 & 240 V. NCC ANALOG CONTROL

17 & 14 KW. SLAVE SOLID STATE SWITCHING

DERIVED FROM 00959348-3 Rev C Refer to Schematic 957331-2

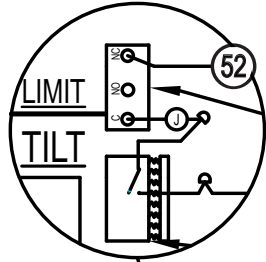
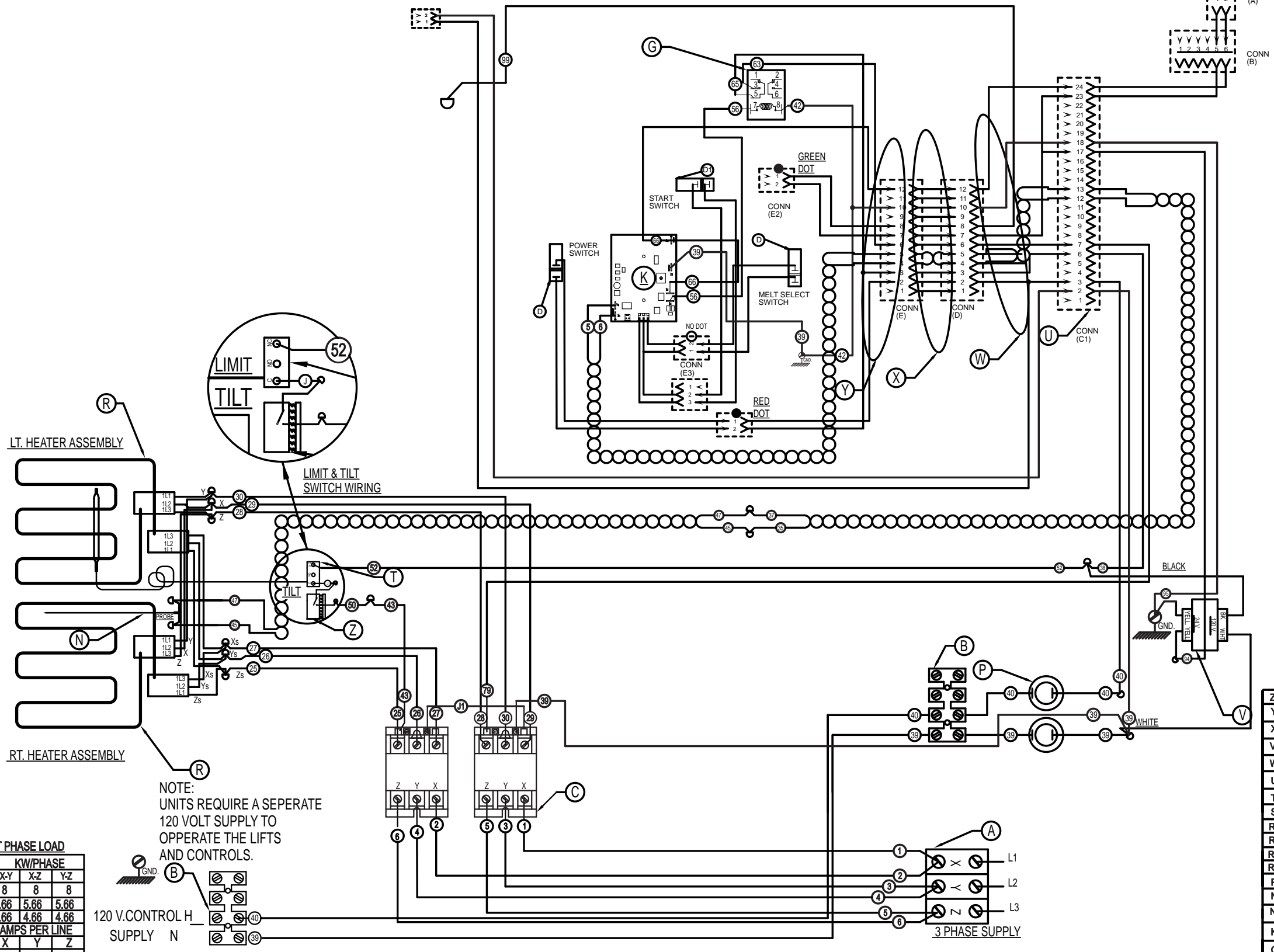

NOTE:
UNITS REQUIRE A SEPERATE
120 VOLT SUPPLY TO
OPERATE THE LIFTS
AND CONTROLS.

480 VOLT PHASE LOAD

TOTAL KW	KW/PHASE		
	X-Y	X-Z	Y-Z
24	8	8	8
17	5.66	5.66	5.66
14	4.66	4.66	4.66
AMPS PER LINE			
	X	Y	Z
24	29	29	29
17	20	20	20
14	17	17	17

Z	SWITCH, LIMIT
Y	HARNES-CONTROL BOX
X	HARNES-POWER TO CONTROL BOX
V	TRANSFORMER 40 VA. 240V./24V.
W	HARNES-POWER DISTRIBUTION
U	HARNES-CABLE ASSEMBLY
T	2ED HIGH LIMIT 460 F
S	ELEMENT, FIREBAR 8.5KW
R3	ELEMENT, FIREBAR 480V. 12KW
R3	ELEMENT, FIREBAR 480V. 10.5KW
R2	ELEMENT, FIREBAR 480V. 8.5KW
R1	ELEMENT, FIREBAR 480V. 7KW.
P	FUSE & HOLDER
N	THERMISTOR PROBE
N	THERMISTOR PROBE
K	NCC TEMPERATURE CONTROL
G	RELAY, DPDT 24V COIL
D1	ROCKER SWITCH ASSEMBLY- START
D	ROCKER SWITCH ASSEMBLY
C	CONTACTOR 3P 50A 230V COIL
B	STRIP-TERMINAL BARRIER
A	TERMINAL BLOCK

WIRING DIA. 480V NCC ANALOG CONTROL

24,21,17 & 14KW. STAND ALONE W SS SWITCHING

DERIVED FROM 00959349-1 Rev B Refer to Schematic 957332-1

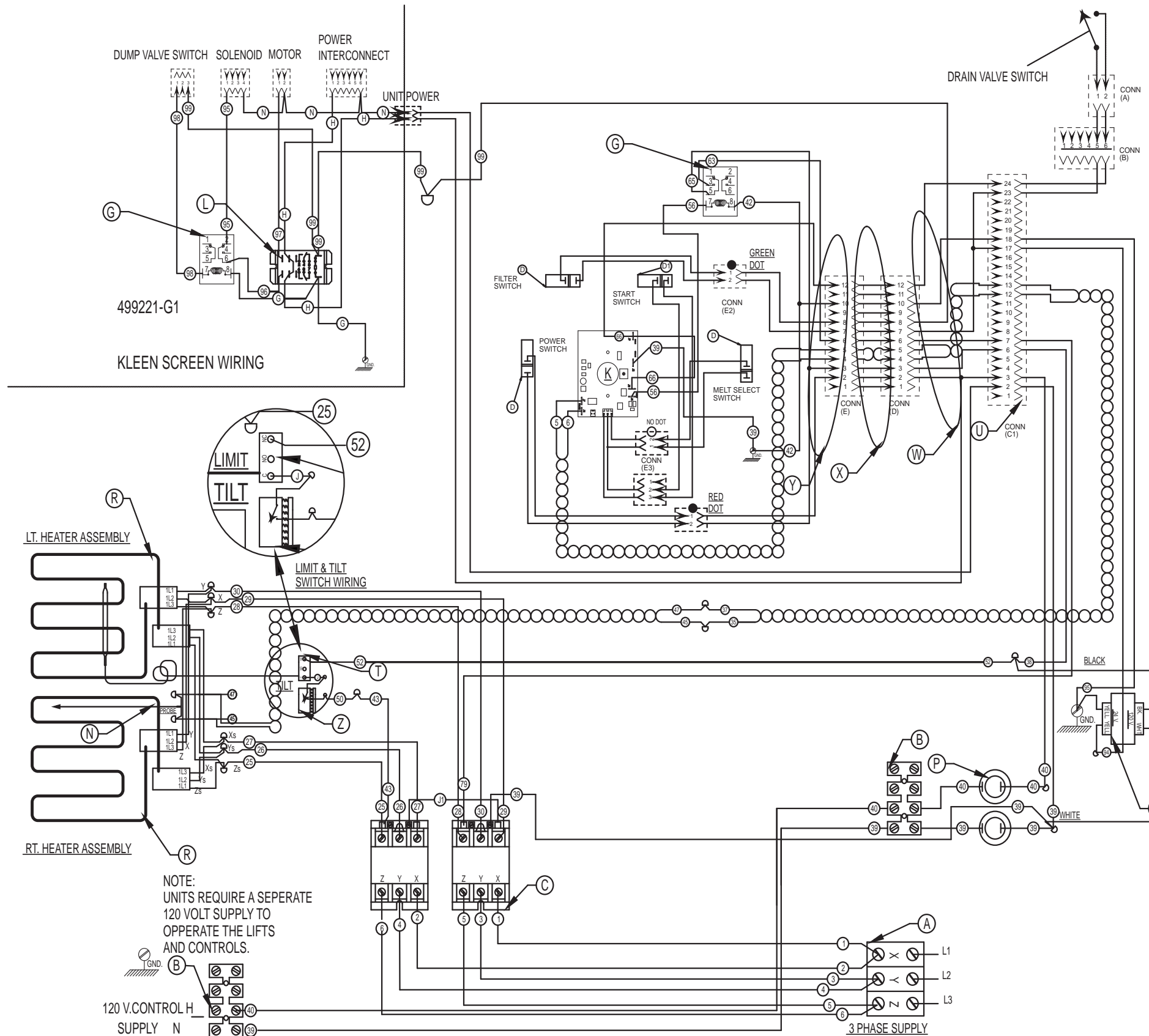

480 VOLT PHASE LOAD

TOTAL KW	KW/PHASE		
	X-Y	X-Z	Y-Z
24	8	8	8
17	5.66	5.66	5.66
14	4.66	4.66	4.66
AMPS PER LINE			
	X	Y	Z
24	29	29	29
17	20	20	20
14	17	17	17

NOTE:
UNITS REQUIRE A SEPERATE
120 VOLT SUPPLY TO
OPERATE THE LIFTS
AND CONTROLS.

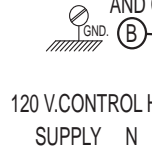

Z	SWITCH, LIMIT
Y	HARNES-CONTROL BOX
X	HARNES-POWER TO CONTROL BOX
W	HARNES-POWER DISTRIBUTION
V	TRANSFORMER 40 VA. 240V./24V.
U	HARNES-CABLE ASSEMBLY
T	2ED HIGH LIMIT 460 F
R3	ELEMENT, FIREBAR 480V 12 KW.
R3	ELEMENT, FIRBAR 480V 10.5 KW.
R2	ELEMENT, FIRBAR 480V 8.5 KW.
R1	ELEMENT, FIRBAR 480V 7 KW.
P	FUSE & HOLDER
N	THERMISTOR PROBE
N	THERMISTOR PROBE
L	RELAY, TYCO T92S11 DPDT 24V COIL
K	NCC TEMPERATURE CONTROL
H	RELAY, DPDT 120V COIL
G	RELAY, DPDT 24V COIL
D1	ROCKER SWITCH ASSEMBLY- START
D	ROCKER SWITCH ASSEMBLY
C	CONTACTOR 3P 50A 230V COIL
B	STRIP-TERMINAL BARRIER
A	TERMINAL BLOCK

24.21.17 & 14KW. MASTER W SS SWITCHING

WIRING DIA. 480V NCC ANALOG CONTROL

DERIVED FROM 0959349-2 Rev B Refer to Schematic 957332-2

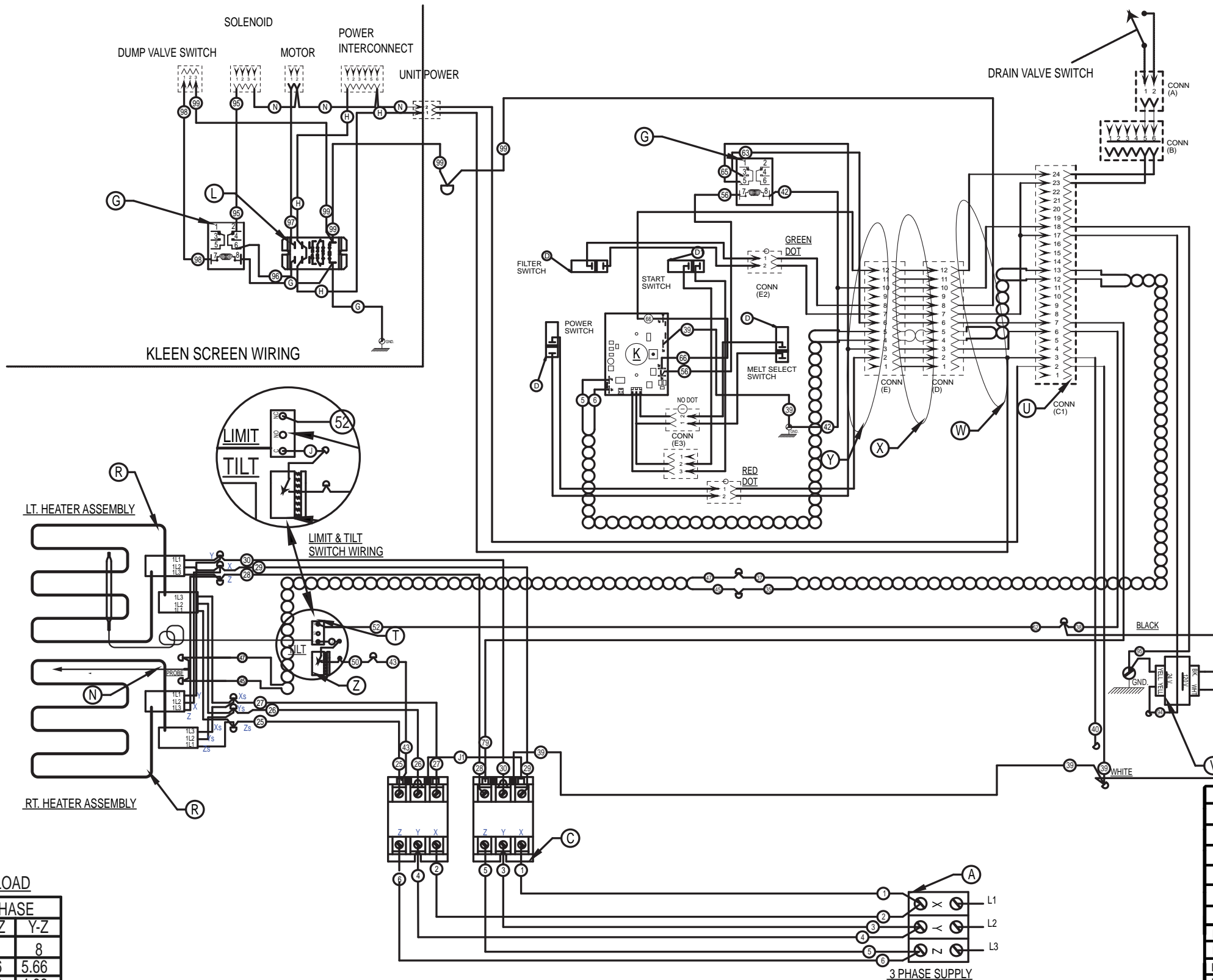

480 VOLT PHASE LOAD

TOTAL KW	KW/PHASE		
	X-Y	X-Z	Y-Z
24	8	8	8
17	5.66	5.66	5.66
14	4.66	4.66	4.66
AMPS PER LINE			
	X	Y	Z
24	29	29	29
17	20	20	20
14	17	17	17

Z	SWITCH, LIMIT
Y	HARNESS-CONTROL BOX
X	HARNESS-POWER TO CONTROL BOX
V	TRANSFORMER 40 VA. 240V./24V.
W	HARNESS-POWER DISTRIBUTION
U	HARNESS-CABLE ASSEMBLY
T	2ED HIGH LIMIT 460 F
R3	ELEMENT, FIREBAR 480V. 12KW
R3	ELEMENT, FIREBAR 480V. 10.5KW
R2	ELEMENT, FIREBAR 480V. 8.5KW
R1	ELEMENT, FIREBAR 480V. 7KW.
N	THERMISTOR PROBE
N	THERMISTOR PROBE
K	NCC TEMPERATURE CONTROL
L	RELAY, TYCO T92S11 DPDT 24V COIL
H	RELAY, DPDT 120V.
G	RELAY, DPDT 24V COIL
D1	ROCKER SWITCH ASSEMBLY- START
D	ROCKER SWITCH ASSEMBLY
C	CONTACTOR 3P 50A 230V COIL
A	TERMINAL BLOCK

24,21,17 & 14KW. SLAVE W SS SWITCHING
 WIRING DIA. 480V NCC ANALOG CONTROL

DERIVED FROM 00959349-3 Rev B Refer to Schematic 957332-2

DRAIN VALVE SWITCH

LT. HEATER ASSEMBLY

RT. HEATER ASSEMBLY

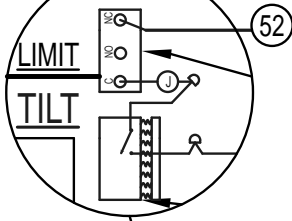

LIMIT & TILT SWITCH WIRING

208-240 VOLT PHASE LOAD

TOTAL KW	KW/PHASE		
	X-Y	X-Z	Y-Z
24	8	8	8
	AMPS PER LINE 208 VOLT		
	X	Y	Z
24	67	67	67
	AMPS PER LINE 240 VOLT		
	X	Y	Z
24	58	58	58

Z	SWITCH, LIMIT
Y	HARNESS-CONTROL BOX
X	HARNESS-POWER TO CONTROL BOX
V	TRANSFORMER 40 VA. 240V./24V.
W	HARNESS-POWER DISTRIBUTION
U	HARNESS-CABLE ASSEMBLY
T	2ED HIGH LIMIT 460 F
S	ELEMENT, FIREBAR 12KW
N	THERMISTOR PROBE
M	CIRCUIT BREAKER 50A 3 POLE
K	NCC TEMPERATURE CONTROL
G	RELAY, DPDT 24V COIL
F1	FILTER ASSEMBLY SINGLE
D1	ROCKER SWITCH ASSEMBLY- START
D	ROCKER SWITCH ASSEMBLY
C	CONTACTOR 3P 50A 230V COIL
B	STRIP-TERMINAL BLOCK
A	TERMINAL BLOCK

WIRING DIA. 208 & 240 VOLT ANALOG

24 KW. STAND ALONE WITH SOLID STATE SWITCHING

DERIVED FROM 00959347-1 Rev B Refer to Schematic 957332-1

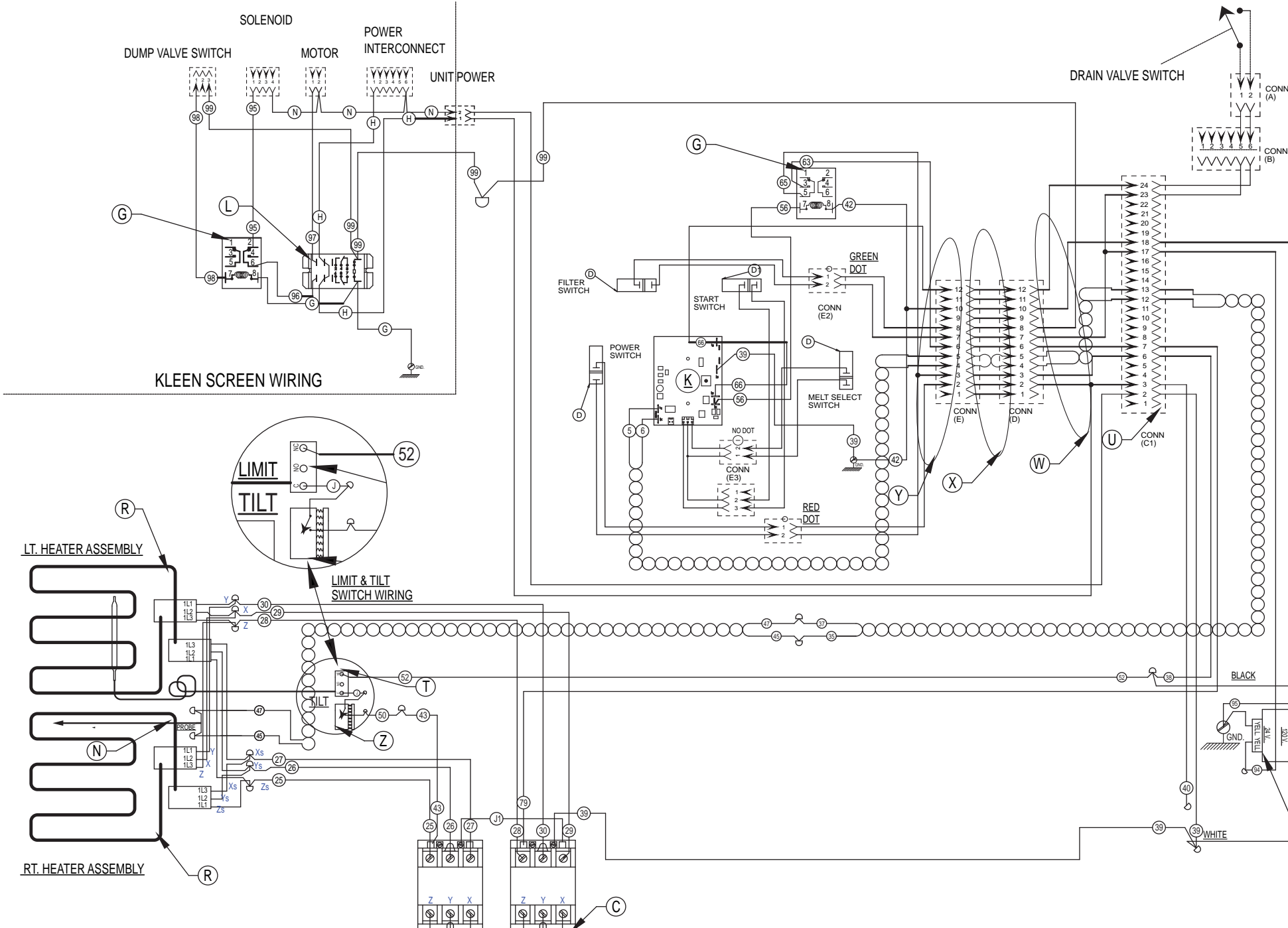

480 VOLT PHASE LOAD

TOTAL KW	KW/PHASE		
	X-Y	X-Z	Y-Z
24	8	8	8
17	5.66	5.66	5.66
14	4.66	4.66	4.66
AMPS PER LINE			
	X	Y	Z
24	29	29	29
17	20	20	20
14	17	17	17

Z	SWITCH, LIMIT
Y	HARNESS-CONTROL BOX
X	HARNESS-POWER TO CONTROL BOX
V	TRANSFORMER 40 VA. 240V./24V.
W	HARNESS-POWER DISTRIBUTION
U	HARNESS-CABLE ASSEMBLY
T	2ED HIGH LIMIT 460 F
R3	ELEMENT, FIREBAR 480V. 12KW
R3	ELEMENT, FIREBAR 480V. 10.5KW
R2	ELEMENT, FIREBAR 480V. 8.5KW
R1	ELEMENT, FIREBAR 480V. 7KW.
N	THERMISTOR PROBE
N	THERMISTOR PROBE
K	NCC TEMPERATURE CONTROL
L	RELY. TYCO T92S11 DPDT 24V COIL
H	RELAY, DPDT 120V.
G	RELAY, DPDT 24V COIL
D1	ROCKER SWITCH ASSEMBLY- START
D	ROCKER SWITCH ASSEMBLY
C	CONTACTOR 3P 50A 230V COIL
A	TERMINAL BLOCK

24,21,17 & 14KW. SLAVE W SS SWITCHING
 WIRING DIA. 480V NCC ANALOG CONTROL

DERIVED FROM 00959349-3 Rev B Refer to Schematic 957332-2

DUMP VALVE SWITCH SOLENOID POWER INTERCONNECT & MOTOR

DRAIN VALVE SWITCH

KLEEN SCREEN RELAY WIRING

LT. HEATER ASSEMBLY

RT. HEATER ASSEMBLY

LIMIT & TILT SWITCH WIRING

3 PHASE SUPPLY

Z	SWITCH, LIMIT
Y	HARNESS-CONTROL BOX
X	HARNESS-POWER TO CONTROL BOX
W	HARNESS-POWER DISTRIBUTION
V	TRANSFORMER 40 VA, 240V/24V.
U	HARNESS-CABLE ASSEMBLY
T	2ED HIGH LIMIT 460 F
S	ELEMENT, FIREBAR 8.5KW
N	THERMISTOR PROBE
M	CIRCUIT BREAKER 50A 3 POLE
K	RELAY, TYCO T92S11 DPDT 24V COIL
G	NCC TEMPERATURE CONTROL
L	RELAY, DPDT 24V COIL
D1	ROCKER SWITCH ASSEMBLY-START
D	ROCKER SWITCH ASSEMBLY
C	CONTACTOR 3P 50A 230V COIL
A	TERMINAL BLOCK

208-240 VOLT PHASE LOAD			
TOTAL KW	KW/PHASE		
	X-Y	X-Z	Y-Z
24	8	8	8
AMPS PER LINE 208 VOLT			
	X	Y	Z
24	67	67	67
AMPS PER LINE 240 VOLT			
	X	Y	Z
24	58	58	58

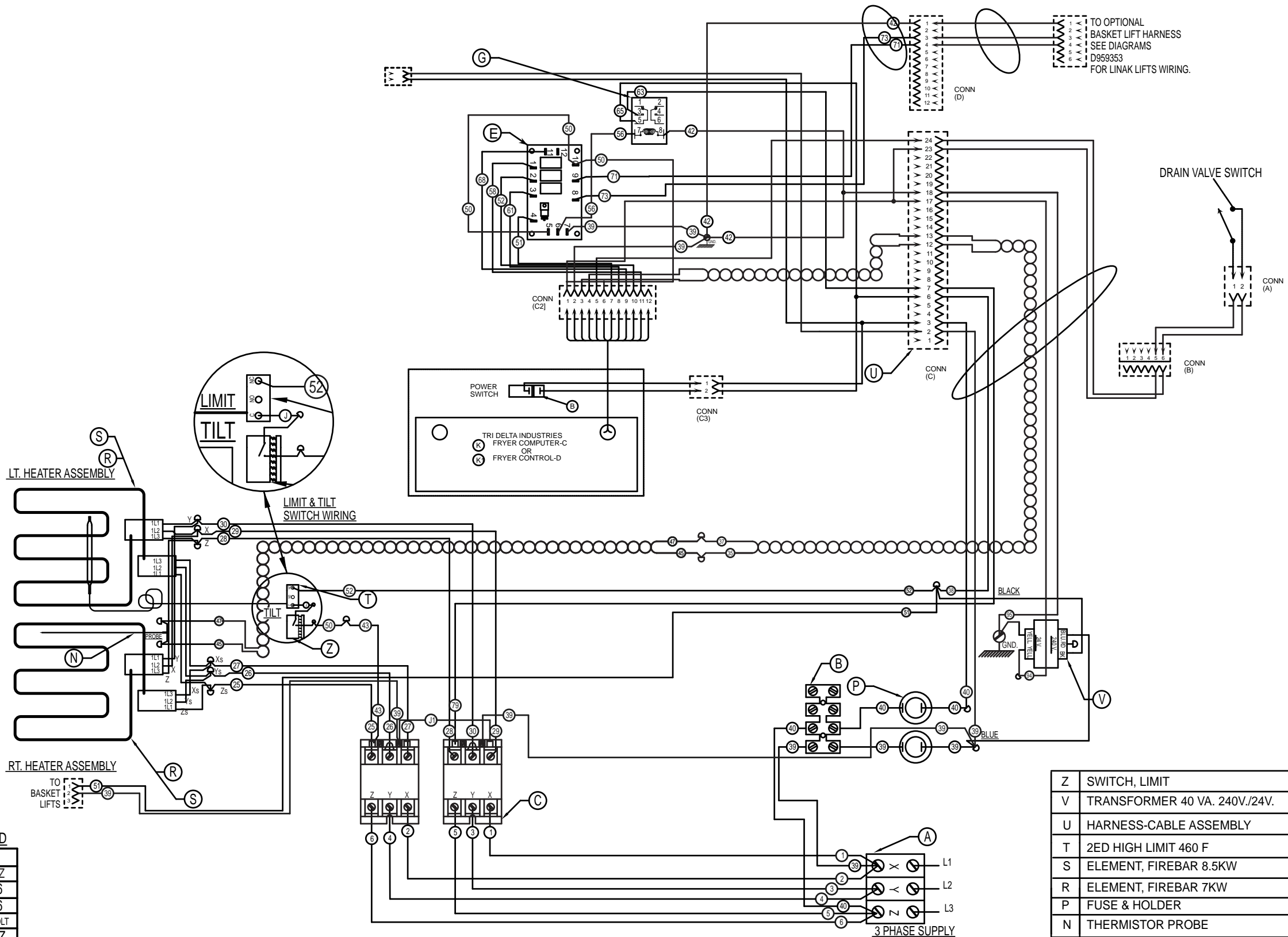

TO OPTIONAL BASKET LIFT HARNESS SEE DIAGRAMS D959353 FOR LINAK LIFTS WIRING.

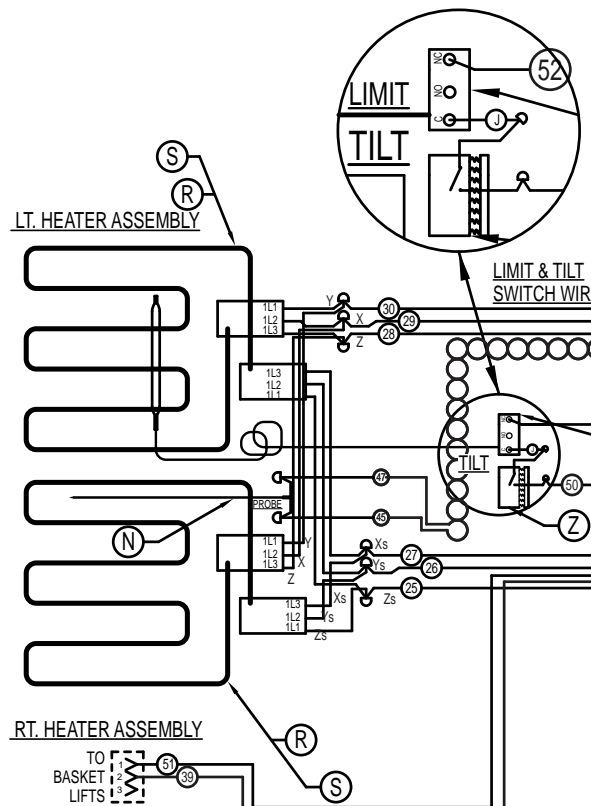

208-240 VOLT PHASE LOAD

TOTAL KW	KW/PHASE		
	X-Y	X-Z	Y-Z
17	5.6	5.6	5.6
14	4.6	4.6	4.6
AMPS PER LINE 208 VOLT			
	X	Y	Z
17	47	47	47
14	39	39	39
AMPS PER LINE 240 VOLT			
	X	Y	Z
17	41	41	41
14	34	34	34

Z	SWITCH, LIMIT
V	TRANSFORMER 40 VA. 240V./24V.
U	HARNESS-CABLE ASSEMBLY
T	2ED HIGH LIMIT 460 F
S	ELEMENT, FIREBAR 8.5KW
R	ELEMENT, FIREBAR 7KW
P	FUSE & HOLDER
N	THERMISTOR PROBE
K1	NCC CONTROL W / TIMER(S)
K	NCC TEMPERATURE CONTROL
G	RELAY, DPDT 24V COIL
E	CONTROL, INTERFACE TRIDELTA
D	ROCKER SWITCH ASSEMBLY
C	CONTACTOR 3P 50A 230V COIL
B	STRIP-TERMINAL BARRIER
A	TERMINAL BLOCK

WIRING DIA. 208 & 240 VOLT NCC CONTROL

17 & 14 KW. FULL-VAT FRYERS STAND ALONE

DERIVED FROM 00959322-1 Rev B Refer to Schematic 428281-1

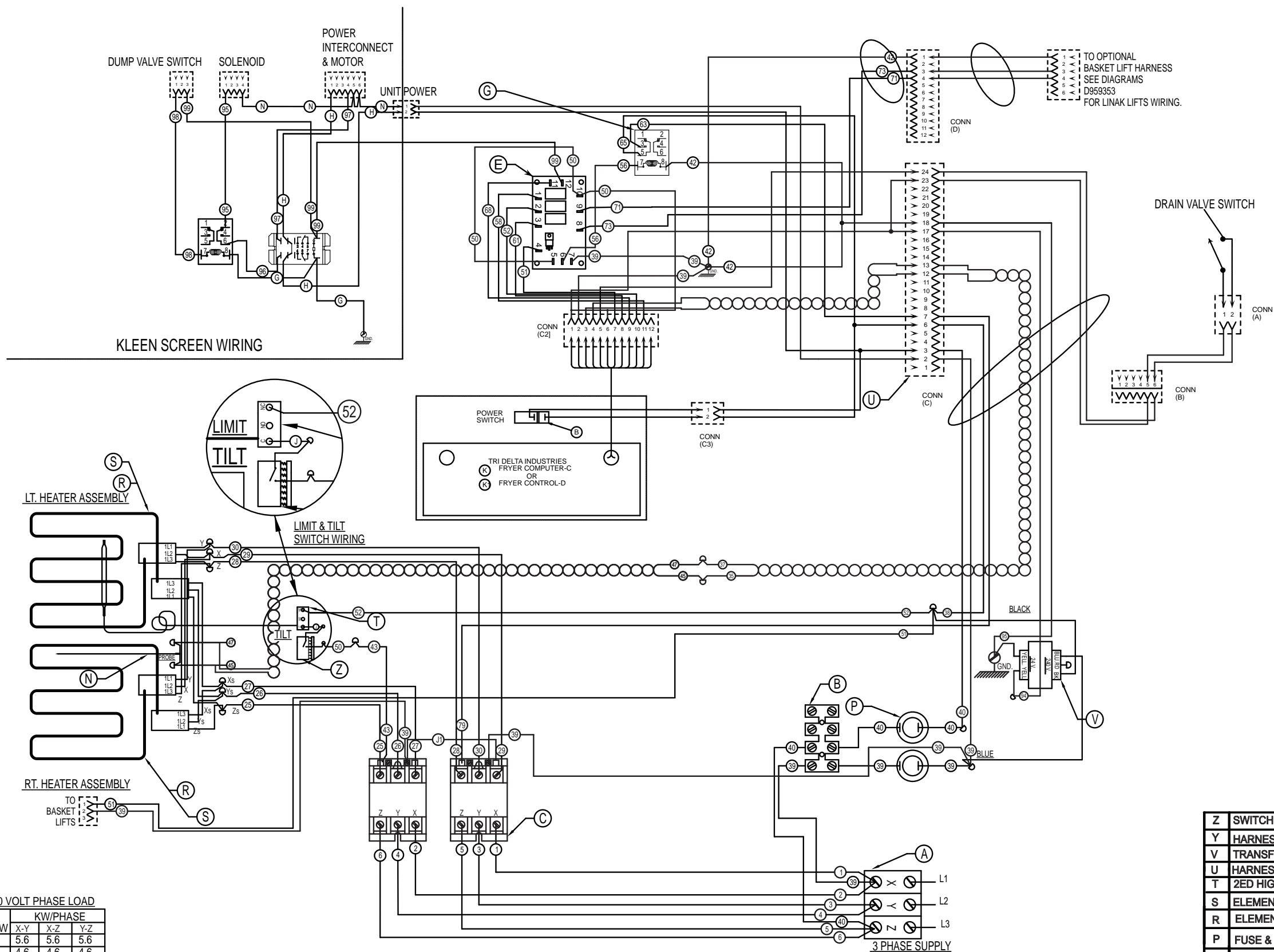

208-240 VOLT PHASE LOAD

TOTAL KW	KW/PHASE		
	X-Y	X-Z	Y-Z
17	5.6	5.6	5.6
14	4.6	4.6	4.6
AMPS PER LINE 208 VOLT			
	X	Y	Z
17	47	47	47
14	39	39	39
AMPS PER LINE 240 VOLT			
	X	Y	Z
17	41	41	41
14	34	34	34

Z	SWITCH, LIMIT
Y	HARNES-CONTROL BOX
V	TRANSFORMER 40 VA. 240V./24V.
U	HARNES-CABLE ASSEMBLY
T	2ED HIGH LIMIT 460 F
S	ELEMENT, FIREBAR 12KW
R	ELEMENT, FIREBAR 7KW
P	FUSE & HOLDER
N	THERMISTOR PROBE
K1	NCC CONTROL W/TIMER(S)
K	NCC COMPUTER
G	RELAY, DPDT 24V COIL
E	CONTROL, INTERFACE TRIDELTA
D	ROCKER SWITCH ASSEMBLY
C	CONTACTOR 3P 50A 230V COIL
B	STRIP-TERMINAL BARRIER
A	TERMINAL BLOCK

WIRING DIA. 208 & 240 VOLT DIGITAL
17 & 14 KW. MASTER SOLID STATE SWITCHING

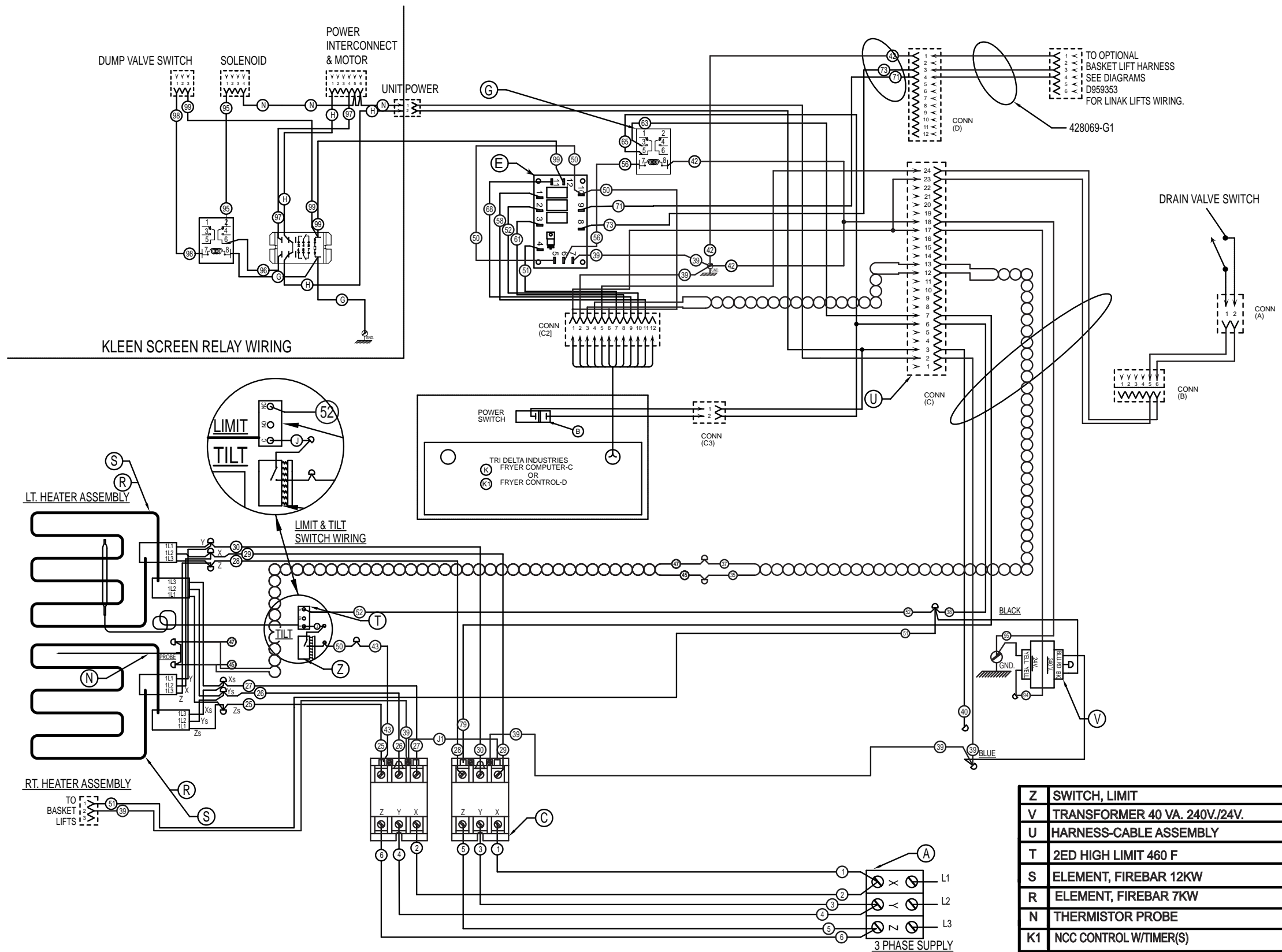

208-240 VOLT PHASE LOAD

TOTAL KW	KW/PHASE		
	X-Y	X-Z	Y-Z
17	5.6	5.6	5.6
14	4.6	4.6	4.6
AMPS PER LINE 208 VOLT			
	X	Y	Z
17	47	47	47
14	39	39	39
AMPS PER LINE 240 VOLT			
	X	Y	Z
17	41	41	41
14	34	34	34

Z	SWITCH, LIMIT
V	TRANSFORMER 40 VA. 240V./24V.
U	HARNES-CABLE ASSEMBLY
T	2ED HIGH LIMIT 460 F
S	ELEMENT, FIREBAR 12KW
R	ELEMENT, FIREBAR 7KW
N	THERMISTOR PROBE
K1	NCC CONTROL W/TIMER(S)
K	NCC COMPUTER
G	RELAY, DPDT 24V COIL
E	CONTROL, INTERFACE TRIDELTA
D	ROCKER SWITCH ASSEMBLY
C	CONTACTOR 3P 50A 230V COIL
A	TERMINAL BLOCK

WIRING DIA. 208 & 240 VOLT DIGITAL

17 & 14 KW. SLAVE SOLID STATE SWITCHING

DERIVED FROM 00959322-3 Rev B Refer to Schematic 428281-1