



# Operation Manual

---



MODEL  
OV310E (ELECTRIC)      ML-132516  
OV310G (GAS)            ML-132515

## OV310G & OV310E MINI ROTATING RACK OVENS

Model Number: \_\_\_\_\_

Serial Number: \_\_\_\_\_

Date of Installation: \_\_\_\_\_

## IMPORTANT FOR YOUR SAFETY

THIS MANUAL HAS BEEN PREPARED FOR PERSONNEL QUALIFIED TO INSTALL GAS EQUIPMENT, WHO SHOULD PERFORM THE INITIAL FIELD START-UP AND ADJUSTMENTS OF THE EQUIPMENT COVERED BY THIS MANUAL.

POST IN A PROMINENT LOCATION THE INSTRUCTIONS TO BE FOLLOWED IN THE EVENT THE SMELL OF GAS IS DETECTED. THIS INFORMATION CAN BE OBTAINED FROM THE LOCAL GAS SUPPLIER.

### IMPORTANT

IN THE EVENT A GAS ODOR IS DETECTED, SHUT DOWN UNITS AT MAIN SHUTOFF VALVE AND CONTACT THE LOCAL GAS COMPANY OR GAS SUPPLIER FOR SERVICE.

### FOR YOUR SAFETY

DO NOT STORE OR USE GASOLINE OR OTHER FLAMMABLE VAPORS OR LIQUIDS IN THE VICINITY OF THIS OR ANY OTHER APPLIANCE.

**⚠ WARNING** IMPROPER INSTALLATION, ADJUSTMENT, ALTERATION, SERVICE OR MAINTENANCE CAN CAUSE PROPERTY DAMAGE, INJURY OR DEATH. READ THE INSTALLATION, OPERATING AND MAINTENANCE INSTRUCTIONS THOROUGHLY BEFORE INSTALLING OR SERVICING THIS EQUIPMENT.

IN THE EVENT OF A POWER FAILURE, DO NOT ATTEMPT TO OPERATE THIS DEVICE.

KEEP AREA AROUND OVEN CLEAR OF COMBUSTIBLES. DO NOT OBSTRUCT COMBUSTION AND VENTILATION OPENINGS ON THE OVEN.

This manual has been prepared to provide information in accordance with ANSI Z83.11-2007 for gas equipment.

# TABLE OF CONTENTS

GENERAL.....	4
INSTALLATION .....	4
Unpacking.....	4
Location .....	5
Installation Codes and Standard .....	5
Assembly .....	5
Gas Connections .....	6
Testing the Gas Supply System.....	6
Ventilation .....	6
Plumbing Connections.....	6
Drain Connections .....	7
Electrical Connections .....	7
OPERATION .....	8
Controls .....	8
Food Service Steam Mode.....	13
Safety Alarm .....	13
Kosher Operation Mode (Ovens Equipped With Kosher Package).....	14
Programming the Oven .....	15
Customized Operation.....	20
Energy Saving Mode .....	23
Shutdown.....	24
Perform LED Display Test.....	24
CLEANING .....	24
MAINTENANCE .....	25
General.....	25
Service and Parts Information .....	25
Removing the Rack .....	26
Update Oven Application Firmware Via USB Drive (For Use on Ovens Supplied with USB Connection Package).....	28
TROUBLESHOOTING .....	29
Burners Will Not Light (Gas Ovens Only).....	29
Safety Alarm .....	29
Alarms and Display Messages .....	29
Circulation Motor .....	29
Rack Rotation .....	29
OWNER PREVENTIVE MAINTENANCE PROCEDURES.....	30
Introduction.....	30
Preventive Maintenance Procedures.....	30

# OPERATION AND CARE OF MODELS OV310G AND OV310E MINI ROTATING RACK OVENS

**SAVE THESE INSTRUCTIONS**

## GENERAL

Models OV310G (Gas) and OV310E (Electric) Mini Rotating Rack Ovens feature the choice of four rack configurations:

- Eight 18" x 26" (45.7 cm x 66 cm) pan capacity rack with 4" (10.2 cm) slide spacing
- Six 18" x 26" (45.7 cm x 66 cm) pan capacity rack with 5.31" (13.5 cm) slide spacing
- Ten 18" x 26" (45.7 cm x 66 cm) pan capacity rack with 3.2" (8.1 cm) slide spacing
- Twelve 18" x 26" (45.7 cm x 66 cm) pan capacity rack with 2.8" (7.1 cm) slide spacing

All oven rack options can be ordered in an end-load design. The six and eight pan options can be ordered in a side-load design. A mechanism in the ceiling rotates the rack during baking.

Model OV310G is rated at 95,000 BTU/hr (natural or propane gas). Model OV310E is rated at 18.0 kW (electric).

Baxter Mini Rotating Rack Ovens are produced with quality workmanship and material. Proper installation, usage and maintenance of the rack oven will result in years of satisfactory performance.

It is suggested that you thoroughly read this manual and carefully follow the instructions provided.

## INSTALLATION

In order to validate the warranty, the start-up must be performed by an Authorized Service Representative. Before installing, verify that the electrical service(s) and type of gas supply (natural or propane) agree with the specifications on the data plate located on top of the oven. If the supply and equipment requirements do not agree, do not proceed with the installation. Contact an authorized Bakery Systems service office immediately.

### UNPACKING

This oven was inspected before leaving the factory. The transportation company assumes full responsibility for safe delivery upon acceptance of the shipment. Immediately after unpacking, check for possible shipping damage. If the oven is found to be damaged, save the packaging material and contact the carrier within 15 days of delivery.

Carefully unpack the oven and place it in a work-accessible area as near to its final installed position as possible. Remove protective covering from exterior surfaces prior to placing oven in final location.

## LOCATION

The OV310G and OV310E Mini Rotating Rack Ovens must have the following minimum clearances to combustibles:

- Back and sides: 0"
- Bottom: 0"
- Top: 18" (45.7 cm)

**NOTE:** Minimum 24" clearance needed for service access on the right-hand side. If right-hand side is within 30" of radiant heat or grease vapor source, vent guard is required.

Be sure that electrical, water and drain connections are accessible and can be made per local and national codes. The equipment area must be kept free and clear of combustible substances.

Do not obstruct the flow of combustion and ventilation air. Adequate clearance for air openings into the combustion chamber must be provided. Make sure there is an adequate supply of air in the room to replace air taken out by the ventilating system.

## INSTALLATION CODES AND STANDARD

The oven must be installed in accordance with:

### In the United States of America:

1. State and local codes.
2. National Fuel Gas Code, ANSI-Z223.1 (latest edition). Copies may be obtained from The American Gas Association, Inc.; 1515 Wilson Blvd.; Arlington, VA 22209.
3. National Electrical Code, ANSI/NFPA-70 (latest edition).

### In Canada:

1. Local codes.
2. CAN/CGA-B149.1 Natural Gas Installation Code (latest edition).
3. CAN/CGA-B149.1 National Fuel Gas Code (latest edition), available from The Canadian Gas Association; 178 Rexdale Blvd.; Etobicoke, Ontario; Canada M9W 1R3.

## ASSEMBLY

The oven must be installed on a stand, proofer cabinet or any noncombustible surface.

The oven must be sealed to the stand with an NSF-approved sealant, such as Dow Corning 732 or GE RTV108.

Secure the oven to the proofer or stand using the provided tie-down brackets, which mount on the front and rear of the oven.

### Oven Mounted on a Stand or Proofer with Caster

For an appliance equipped with casters, instructions that (1) the installation shall be made with a connector that complies with the Standard for *Connectors for Movable Gas Appliances, ANSI Z21.69* or *Connectors for Moveable Gas Appliances, CAN/CGA-6.16*, and a quick-disconnect device that complies with the Standard for *Quick-Disconnect Devices for Use With Gas Fuel, ANSI Z21.41*, or *Quick Disconnect Devices for Use with Gas Fuel, CAN1-6.9*, (2) adequate means must be provided to limit the movement of the appliance.

## GAS CONNECTIONS

**NOTICE** Gas supply connections and any pipe joint compound must be resistant to the action of propane gases.

The OV310G is an indirect gas-fired oven, consisting of a heat exchanger with eight independent, U-shaped tubes, each with a separate in-shot burner rated at 11,875 BTU/hr for a total input of 95,000 BTU/hr.

**WARNING** Prior to lighting, check all joints in the gas supply line for leaks. Use soap and water solution. Do not use an open flame.

## TESTING THE GAS SUPPLY SYSTEM

When gas supply pressure exceeds  $\frac{1}{2}$  psig (3.45 kPa), the oven and its individual shutoff valve must be disconnected from the gas supply piping system.

When gas supply pressure is  $\frac{1}{2}$  psig (3.45 kPa) or less, the oven should be isolated from the gas supply system by closing its individual manual shutoff valve.

## VENTILATION

Information on the construction and installation of ventilating hoods may be obtained from the standard for *Vapor Removal from Cooking Equipment*, NFPA No. 96 (latest edition), available from the *National Fire Protection Association*, Batterymarch Park, Quincy, MA 02269.

### Exhaust Fan Interlock

A connection point (maximum 5-amps) is provided for Indirect Vent (Exhaust Hood) or optional Direct Vent (Draft Hood). It is located behind the right side service panel adjacent to the 120 V power connection. Consult local codes for vent interlock requirements.

### Indirect Vent (Under Exhaust Hood) - Standard

Locate the oven under an exhaust hood with adequate overhangs and exhaust rates to completely capture the by-products of combustion discharged from the flue. From the termination of the flue to the filters of the hood venting system, a minimum clearance of 18" (45.7 cm) must be maintained. The hood exhaust fan can be electrically interlocked with the oven.

## PLUMBING CONNECTIONS

Water and waste piping and connections shall comply with the International Plumbing Code 2003, International Code Council (ICC), or to the Uniform Plumbing Code 2003, International Association of Plumbing and Mechanical Officials (IAPMO).

**WARNING** Plumbing connections must comply with applicable sanitary, safety and plumbing codes and provide adequate backflow protection to comply with applicable federal, state and local codes.

Oven water supply should have a hardness of 4 to 6 grains per gallon, pH of 6.5 to 8.0 and chlorides less than 30 PPM. Water condition outside of these requirements may void the warranty. Please consult your local water company and/or water condition dealer before installing oven.

Connect the cold water supply to the  $\frac{1}{2}$ " NPT incoming water connection located at the rear of the oven. Water supply should have a pressure of 30 to 75 psi (207 to 517 kPa) when the steam solenoid is open.

## DRAIN CONNECTIONS

Connect a 1/2" drain line to the 1/2" NPT drain connection located at the rear of the oven. Route the drain line to a floor drain, allowing a minimum 1" air gap between the drain line outlet and floor drain.

If oven is being installed on an MB300 Proofing Cabinet, it is recommended that separate drain lines be provided. If it is necessary to interconnect the oven and proofer drains, provide a vent opening in the drain line above the oven drain connection location. Adequate drop must be provided such that the oven drain will not flood the proofer cabinet.

## ELECTRICAL CONNECTIONS

**⚠ WARNING** Electrical and grounding connections must comply with the applicable portions of the National Electrical Code and/or other local electrical codes.

**⚠ WARNING** Disconnect the electrical power to the machine and follow lockout / tagout procedures.

**⚠ WARNING** Appliances equipped with a flexible electric supply cord are provided with a three-prong grounding plug. This plug must be connected into a properly grounded three-prong receptacle. If the receptacle is not the proper grounding type, contact an electrician. Do not remove the grounding prong from this plug.

The wiring diagram is located behind the side service panel on the right side of the oven.

**⚠ WARNING** Do not connect the OV310G gas model to the electrical supply until after gas connections have been made.

The OV310E is an electrically heated oven consisting of six W-shaped elements, each rated at 3.0 kW for a total input of 18.0 kW. The electrical input is shown in the table below.

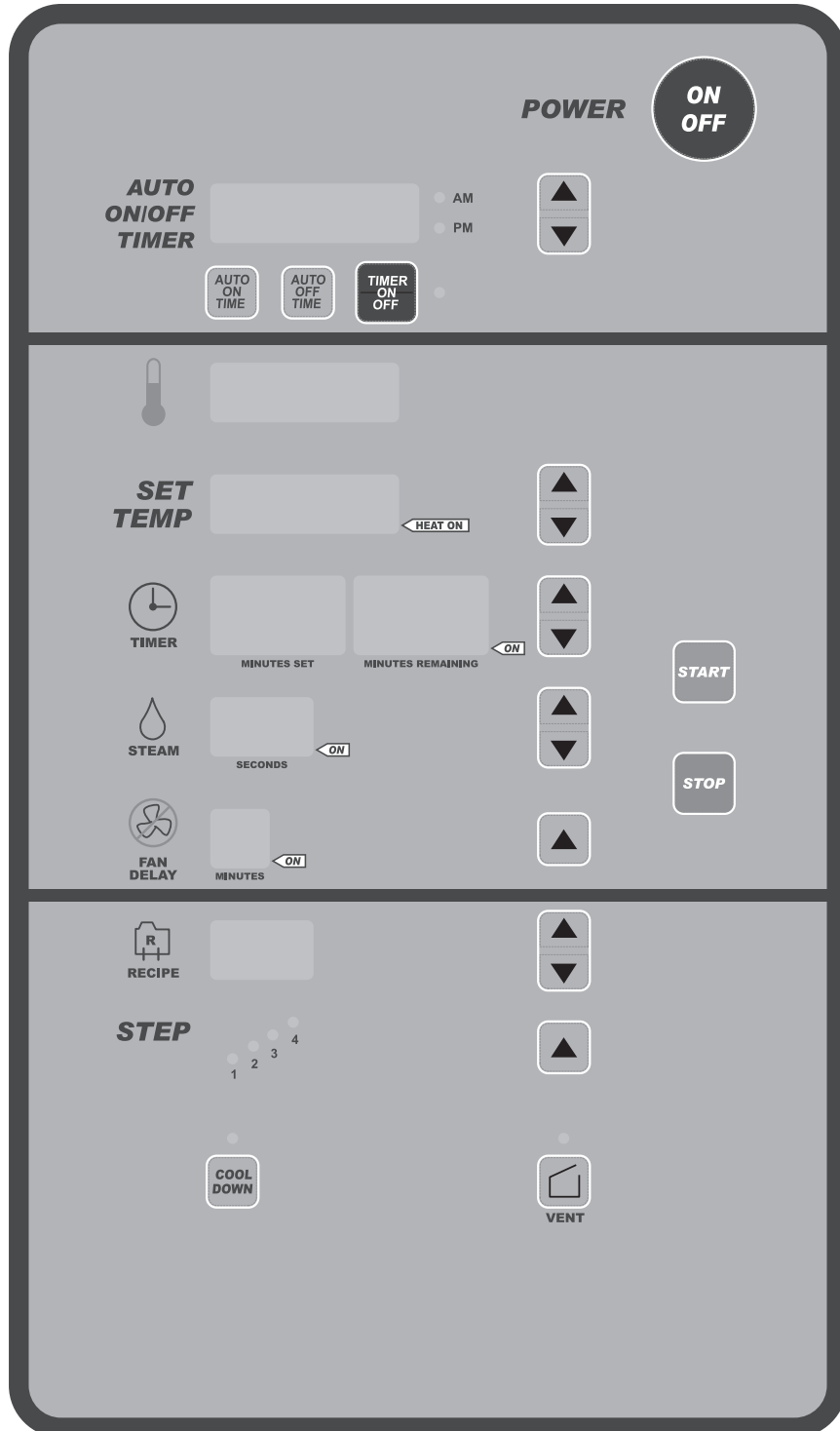
HEATING CIRCUIT SUPPLY VOLTAGE			
Volts	Hertz	Phase	Amps
208	50-60	3	50
240	50-60	3	43
480	50-60	3	22

Both gas and electric ovens require a dedicated 15-amp, 110 V 50 Hz or 120 V 60 Hz, single-phase supply with ground, connected at the control circuit terminal block located behind the right side service panel. If oven is installed in conjunction with an MB300 Proofing Cabinet, a separate 120 V supply is required for the proofer.

# OPERATION














**⚠ WARNING** The mini-rack oven and its parts are hot. Use care when operating, servicing or cleaning the oven.



## CONTROLS





## Control Guide - Advanced

BUTTON	ACTION	DISPLAY
	Press to turn the oven ON or OFF	Control panel displays are lit when the oven is on. Oven defaults to Program 0. If oven is turned OFF and back ON within 2 minutes, the oven will come up in the last mode and oven setting.
<i>AUTO ON/OFF TIMER</i> 	Press to enter current time or time for oven to automatically turn ON or OFF, when corresponding Auto On Time or Auto Off Time button is pressed.	The AUTO ON/OFF TIMER window displays the current time or the time the oven will automatically turn ON or OFF.
<i>AUTO ON TIME</i> 	Press arrow keys to set the desired time of oven to automatically turn ON.	The AUTO ON/OFF TIMER window displays the time the oven will automatically turn ON.
<i>AUTO OFF TIME</i> 	Press arrow keys to set the desired time of oven to automatically turn OFF.	The AUTO ON/OFF TIMER window displays the time the oven will automatically turn OFF.
<i>TIMER ON/OFF</i> 	Press to turn the automatic timer ON or OFF.	The indicator light beside the timer ON/OFF button is lit when the function is enabled.
<i>SET TEMP</i> 	Use to enter bake programs.	The SET TEMP window displays the set temperature. The heat ON light is lit while the oven is heating. The actual temperature in the oven cavity is displayed in the OVEN TEMP window.
<i>BAKE TIMER</i> 	Press arrow keys to enter the BAKE time (1 minute increments). Press the up arrow key to enter additional time at the end of the bake program.	The BAKE TIMER window displays the amount of time for the current baking cycle. The minutes set are the left two digits and minutes remaining are the right two digits. The windows can be set to display hours and minutes remaining. The ON light is lit when bake time is active.
<i>STEAM TIMER</i> 	Press to enter the STEAM time (5-second increments in Bakery mode; 1-second increments in Food Service mode).	The STEAM TIMER window displays the amount of time set for the steam cycle. The ON light is lit when the steam system is active.
<i>FAN DELAY</i> 	Press to enter into beginning of baking cycle.	The DELAY TIMER window displays the amount of time set for the circulation blower to delay air flow through the oven chamber from 0-9 minutes.
	Press to start the BAKE TIMER.	The ON light blinks when the BAKE TIMER is active.
	Press to stop the BAKE. TIMER or silence the beeper after the BAKE TIMER has timed out.	The ON light is off when the BAKE TIMER is inactive.
<i>RECIPE</i> 	Press the arrow keys to select a bake program.	The RECIPE window displays the number of the current program.
<i>STEP</i> 	Use to enter bake programs.	The corresponding indicator light will be lit (1 to 4), depending on which step is selected.

BUTTON	ACTION	DISPLAY
 VENT	Press to open or close the vent manually.	The indicator light next to the VENT button is lit when the vent cycle is enabled.  Select the vent to be open during a recipe step by enabling this during the edit mode.  This button can also be used to COOL DOWN the oven while the door is open.  To use this feature, have set temperature at least 25°F (14°C) cooler than the oven temperature then press the VENT button.  This COOL DOWN mode is exited by pressing any button or closing the door.
 COOL DOWN	Use to cool down the oven.	To enable this feature, set a temperature at least 25°F (14°C) cooler than the oven temperature then press the COOL DOWN button.  The COOL DOWN mode is exited when temperature reaches 25°F (14°C) below set temperature when the door is open, or when the temperature is below the set temperature when the door is closed or by pressing any button.  Opening or closing the door does not cause this COOL DOWN mode to exit.

## Auto ON/OFF Timer

### Setting Clock

Auto ON/OFF Timer display shows the current time of day. To set the clock, the control must be turned on. Press and hold either of the arrow buttons until the colon between the hours and minutes display stops blinking. Use the up and down arrow buttons to adjust time of day. After 5 seconds of no use, the colon will start to blink again.

The oven can be set to turn itself on and off. After the Auto ON/OFF Timer is set, the POWER ON OFF button can be pressed to turn the oven off. This will not disrupt the AUTO ON/OFF setting. Electrical power to the oven must remain on.

1. To set the oven to turn on, press and *hold* the AUTO ON TIME button. The previously entered start time will appear in the display. Use the UP and DOWN arrows to adjust the start time. Then release the AUTO ON TIME button.
2. To set the oven to turn off, press and *hold* the AUTO OFF TIME button. The previously entered end time will appear in the display. Use the UP and DOWN arrows to adjust the end time. Then release the AUTO ON TIME button.
3. To enable the automatic start, press the TIMER ON/OFF button until the indicator LED to the right of the TIMER ON/OFF button is illuminated.

### Backup Battery

The clock is backed up by a lithium battery, which keeps the clock circuitry operating when all external power is off. If the battery becomes low or dead while the external power is off, the display will read 12:00 (12 hr mode) or 0:00 (24 hr mode) and will not increment until a new time is set. The clock will operate with a dead or missing battery, but must be set each time external power is turned on. Batteries should be replaced when low or dead to avoid corrosive damage to the circuitry.

## Oven Preheat

For best results, the oven must be preheated to bake temperature before baking begins.

1. Press the POWER ON OFF button to turn the oven on.



2. Press the UP or DOWN arrows in the TEMP section to enter the desired baking temperature.



3. Confirm that the doors are closed.
4. Allow 30 minutes for the oven to reach the set temperature and the steam system to charge.
5. The oven is now ready for baking operations.

## Basic Operation

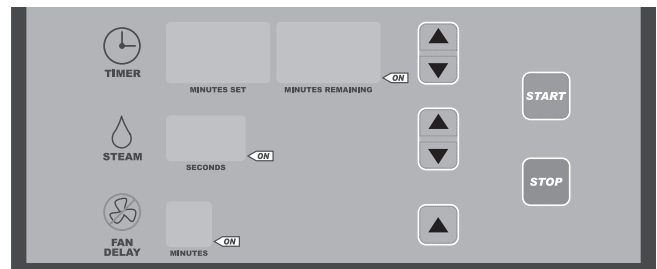
**⚠ WARNING** The oven and its parts are hot. To prevent burns, use hot pads or protective mitts when loading or unloading the oven.

**⚠ WARNING** Hot air and steam are released from the oven interior when the loading doors are opened. To avoid burns, open the doors slowly and keep clear of the opening.

1. Preheat the oven. See Oven Preheat.

2. Manually select baking settings:

- Press the UP or DOWN arrows next to BAKE TIMER to enter the desired value.
- Press the UP or DOWN arrows next to STEAM TIMER to enter the desired value.
- Press the UP arrow next to FAN DELAY to enter the desired value.
- The steam and fan delay settings are optional and can be left at 0 if desired.



3. Slowly open the doors. Wait for the rack to stop. Load the oven. Close the doors.
4. Press the START button. The ON light in the BAKE TIMER window blinks until the timer times out.
5. The oven beeps after the BAKE TIMER times out. Press STOP to silence the beeper.

## Operational Hints

- On the initial startup, the oven temperature will default to the factory setting of 375°F (191°C) unless changed using customized operations.
- During a baking cycle, the START and STOP buttons control the BAKE, STEAM and FAN DELAY settings only. They have no effect on the oven heat. When the BAKE TIMER times out, the oven heat stays at the set temperature. Care should be taken not to overbake products.
- To adjust the temperature during a baking cycle, press the UP or DOWN arrows in the Oven Temp section to enter the new temperature.
- To adjust the BAKE, STEAM and FAN DELAY settings, press the corresponding arrows to enter the new values. There must be bake time set, if steam time is required. Press START when finished.
- Circulation blower will pulse during a steam cycle to assist steam distribution. It does not attain full speed.
- If the doors are opened at any time during the baking cycle, the TEMP, BAKE TIME, STEAM and FAN DELAY settings will pause. Close the doors to resume all functions.
- The FAN DELAY option minimizes airflow at the beginning of the baking cycle. The heat is off while the FAN DELAY is activated.
- If the oven temperature is more than 20°F (11°C) higher than the set temperature, and the bake timer is not activated, the oven will automatically open the VENT. The VENT will remain open until the oven temperature is within 20°F (11°C) of the set temperature.
- The oven monitors the heating system by comparing the current oven temperature to the set temperature. If a problem arises in the heating system or there is a heating system failure, both temperature displays will flash. If the problem continues, contact your authorized Bakery Systems service agency.
- The COOL DOWN feature provides a means of cooling down the oven. To enable this feature, set a temperature at least 25°F (14°C) cooler than the oven temperature. Press the COOL DOWN button—the display alternately shows the set temperature and COOL and the vent opens. Additionally, the doors can be opened and the circulation fan will continue to run. The COOL DOWN mode is exited by the oven temperature reaching set temperature (25°F (14°C) below set temperature if doors are opened) or by pressing any button.
- The oven rack will rotate only after there is time entered into the bake timer and the START button has been pressed. Rotation will start when both doors are closed. If there is no time entered into the bake timer, the display will flash. Press STOP and the controller will stop flashing. Once started, the rack will continue to rotate until a door is opened.
- Circulation fan will stop running if the oven set point is reached and there is no ("0") time displayed on the controller.

## FOOD SERVICE STEAM MODE

This mode can be used to provide steam on a periodic basis throughout operation. When this mode is enabled, the STEAM TIMER controls how many seconds of steam are provided to the oven, while a value entered in the Parameter 14 (P14) setup controls how frequently the steam is operated.

To enable the Food Service Steam mode:

1. Enter the parameter setup mode. (See Entering Setup Mode.)
2. Select Parameter 14.
3. If the BAKE TIMER window displays '0', it is set up for Bakery Mode (factory default). Press the UP or DOWN arrow buttons to enter FSS mode (display will change to a 3-digit number).
4. Set the desired time between steam cycles using the UP or DOWN arrow buttons. The range is from 300 seconds (5 min.) to 990 seconds (approximately 17 min.), and increments by 10 seconds at a time.
5. After setting the desired cycle, press the POWER ON OFF button to save the settings.
6. The STEAM TIMER will now operate in 1-second increments, up to 10 seconds, to set the duration of steaming.

Examples: '300' is selected for P14

'3' is entered in STEAM TIMER

= steam is turned on for 3 seconds every 300 seconds (5 min.)

'990' is selected for P14

'3' is entered in STEAM TIMER

= steam is turned on for 3 seconds every 990 seconds (17 min.)

To return the oven to Bakery Mode, repeat the above process to access P14 and set the value in the BAKE TIMER window to '0'. The STEAM TIMER will now operate in 5-second increments.

## SAFETY ALARM (STANDARD FEATURE, NO PARAMETER SETUP REQUIRED)

If the temperature at the probe is in the range of 570 - 600 degrees Fahrenheit for 10 seconds, the unit will do the following:

1. Shut off all features.
2. Sound an alarm.
3. Flash the OVEN TEMP display (actual temperature is displayed).
4. Display the letters 'SHdn' in the BAKE TIMER display.

**⚠ WARNING** Disconnect the electrical power to the machine and follow lockout/tagout procedures. There may be multiple circuits. Be sure all circuits are disconnected.

**⚠ WARNING** If gas oven, shut off gas. Contact your authorized Bakery Systems service office. Do not attempt to restart the oven until it has been inspected by an authorized servicer.

## **KOSHER OPERATION MODE (OVENS EQUIPPED WITH KOSHER PACKAGE)**

**NOTE:** The oven will be put into Kosher operation mode by authorized personnel at the time of start-up.

**NOTE:** Setting up the parameters and adding programs to the controller should be done before the initial start-up since the oven controller has to be shut off to do this.

For Kosher operations, the oven must maintain a minimum temperature in order to retain Kosher approval. The oven control will make the minimum set temperature 200°F in order to maintain minimum temperature requirements. The oven controller can not be set below 200° F.

If the oven temperature is at risk of falling below the approved range, a rapid beep alarm will sound (faster than the normal TIMER alarm). If you hear this alarm, do the following:

- Check that the oven door is closed.
- If the Vent mode is active, turn the Vent off.

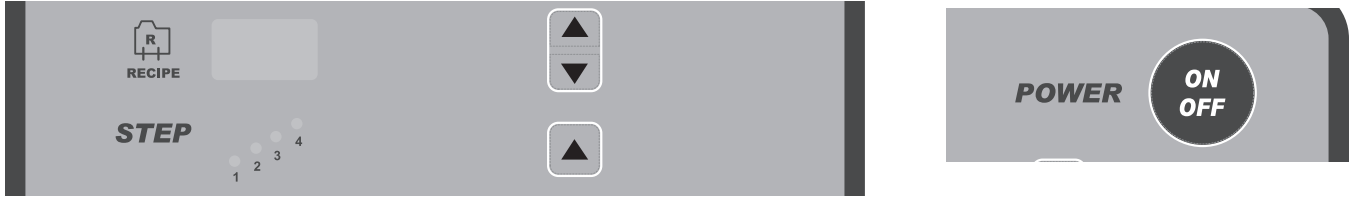
If the oven temperature falls below 150°F, the control will lock out. The display will read 'LOC OUT' and the unit will not operate. Authorized personnel must be contacted to restart the oven.

If the control is inadvertently turned OFF while in kosher mode, when powered ON, the control will re-start in kosher mode as long as the temperature has not dropped below the minimum requirements.

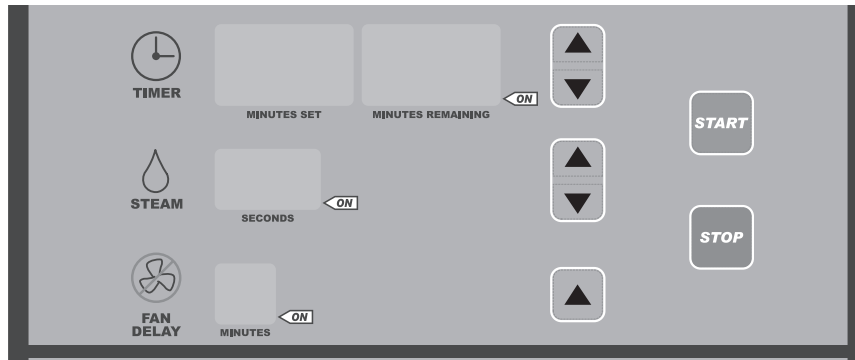
## PROGRAMMING THE OVEN

### Single Step Recipes

The recipe menu stores up to 99 recipes that can be recalled by number when needed. A recipe is a set of baking instructions (temperature, bake, steam and fan delay settings) that the operator defines for any baking operation.



1. With the oven in the OFF mode, press and hold the UP arrow in the STEPS section. While pressing and holding the UP arrow, press the POWER ON OFF button for 3 seconds. When the beep sounds, the oven is in recipe mode.
2. Press the RECIPE UP or DOWN arrows until the recipe number that is desired is displayed.
3. Press the TEMP UP or DOWN arrows to enter the desired temperature.



4. Set the Bake, Steam, Delay Fan and Vent settings:
  - Press the UP or DOWN arrows next to BAKE TIMER to enter the desired time.
  - Press the UP or DOWN arrows next to STEAM TIMER to enter the desired time. If no time is needed enter 0.
  - Press the UP arrow next to FAN DELAY to enter the desired time. If no delay is required leave set at 0.
  - Press the VENT button to vent the cavity for the entire time of the step. For vent button location see illustration on page 8. Vent button is located in the lower right hand corner of the control panel. When step is complete, vent will close.

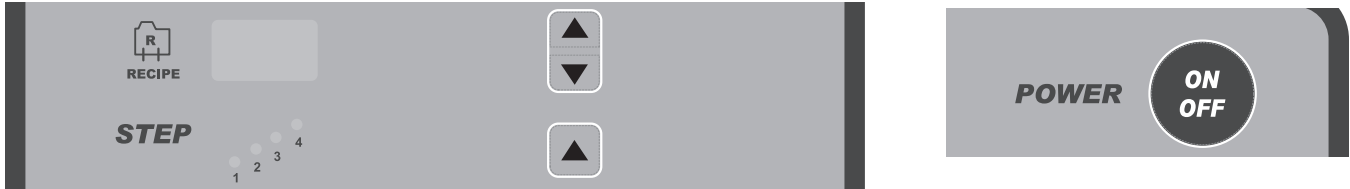


5. To store the recipe, press the RECIPE UP or DOWN arrows to move to the next recipe number or press the POWER ON OFF button to exit the recipe mode.
6. To store additional recipe settings, repeat steps 2 to 4.
7. Record recipe numbers and product associated with them.

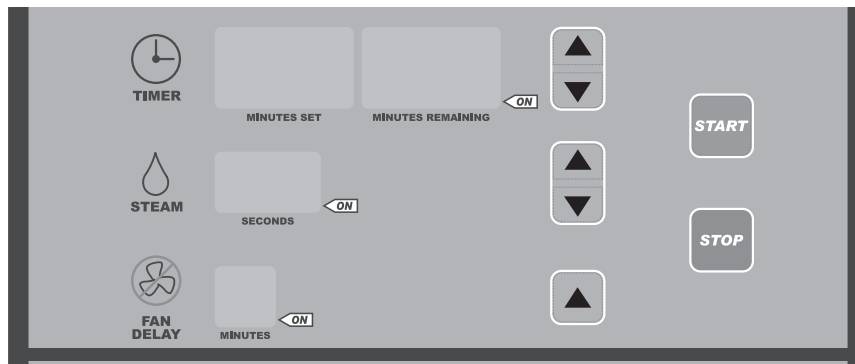
## Multi-Step Recipes

Additional steps can be entered within the original recipe number. Up to four individual steps can be added by the operator, each with different bake settings.

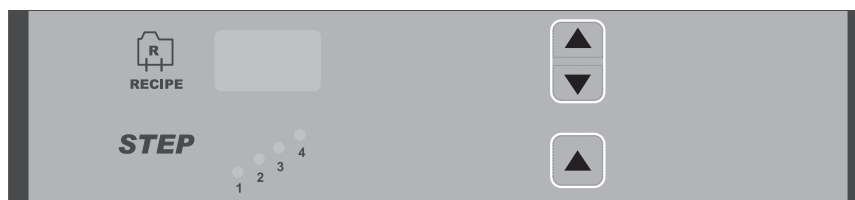
For example, Recipe 1 has temperature, bake, steam and delay time settings set by the operator. This is known as Step 1. After the timer times out in Step 1, the oven automatically starts the programmed bake settings in Step 2. The system continues with each step until all steps have been timed out.



1. With the oven in the OFF mode, press and hold the UP arrow in the STEPS section. While pressing and holding the UP arrow, press the POWER ON OFF button for 3 seconds. When the beep sounds, the oven is in recipe mode.
2. Press the RECIPE UP or DOWN arrows until the recipe number that is desired is displayed. The Step 1 light is lit.
3. Press the TEMP UP or DOWN arrows to enter the desired temperature.



4. Set the Bake, Steam, Delay Fan and Vent settings:
  - Press the UP or DOWN arrows next to BAKE TIMER to enter the desired time.
  - Press the UP or DOWN arrows next to STEAM TIMER to enter the desired time. If no time is needed enter 0.
  - Press the UP arrow next to FAN DELAY to enter the desired time. If no delay is required leave set at 0.
  - Press the VENT button to vent the cavity for the entire time of the step. For vent button location see illustration on page 8. Vent button is located in the lower right hand corner of the control panel. When step is complete, vent will close.



5. Press the UP arrow in the STEPS section to advance to the next step within the recipe. The selected step light is lit.
6. Repeat steps 3 and 4 above to set each step, if needed, in the program.
7. To store all the steps in the program, press the RECIPE UP or DOWN arrows to move to the next recipe number, or press the POWER ON OFF button to exit the recipe mode.

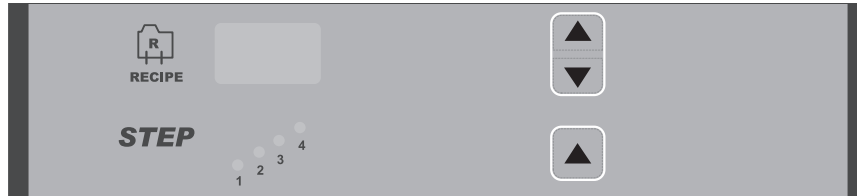


## Editing the Recipes

1. With the oven in the OFF mode, press and hold the UP arrow in the STEPS section. While pressing and holding the UP arrow, press the POWER ON OFF button for 3 seconds. When the beep sounds, the oven is in recipe mode.

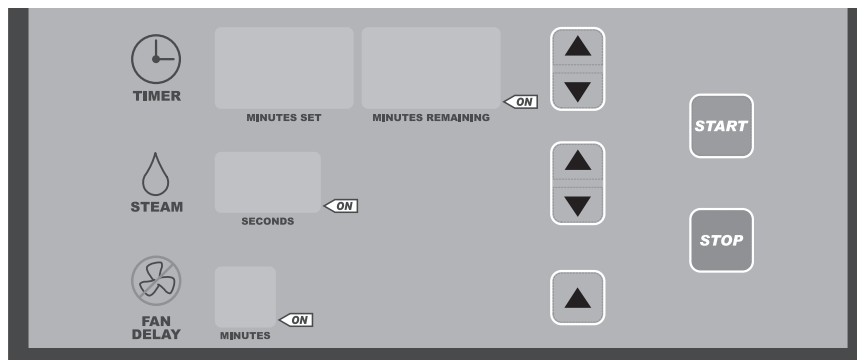


2. Press the RECIPE UP or DOWN arrows until the recipe number that is desired is displayed.



3. Enter the new Bake, Steam and Delay Fan settings:

- Press the UP or DOWN arrows next to BAKE TIMER to enter the desired time.
- Press the UP or DOWN arrows next to STEAM TIMER to enter the desired time. If no time is needed enter 0.
- Press the UP arrow next to FAN DELAY to enter the desired time. If no delay is required leave set at 0.



4. To change the settings in a Step, press the UP arrow in the STEPS section and make changes in each step accordingly.
5. To store the recipe, press the RECIPE UP or DOWN arrows to move to the next recipe number or press the POWER ON OFF button to exit the recipe mode.

## Clearing All Recipes

1. Switch the oven into the OFF mode.
2. Press and hold the Recipe down button then press and hold the POWER ON OFF button until you hear a single short beep and followed by a longer beep. This long beep indicates that the recipes have been cleared.



## Loading Recipes via USB Flash Drive (For Use on Ovens Supplied with USB Connection Package)

1. Switch the oven into the OFF mode.
2. Insert the flash drive that contains the recipe binary file [RECIPE.BIN] into the USB socket.
3. Press and hold the STOP button then press and hold the POWER ON OFF button, keep holding both buttons until the word 'UPdt' [Update] is displayed in the clock field.

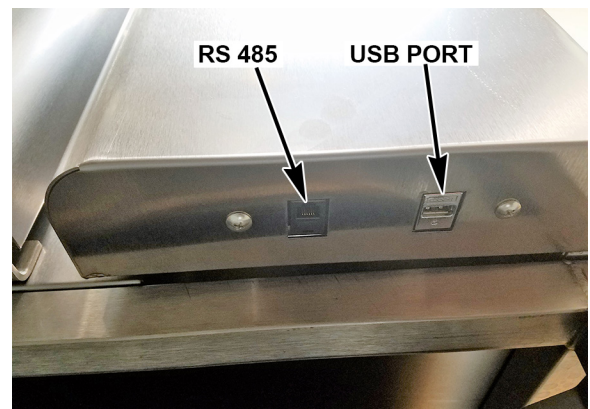
Once the recipe file has been imported into the oven successfully, the display will show 'rebooting' for a few seconds and the oven controller will reboot.

If there are any errors reading or programming the recipe file into the oven, the error will be displayed and the oven will not reboot. You will need to power off the oven, wait 10 seconds, and then power on the oven to make it operable again.

If no binary file, Firmware or Recipe, is found the display will show:

'UPdt-FAIL-USb-Err' [Update fail USB error]

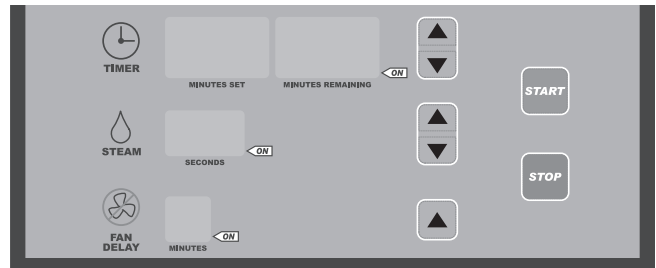
To correct this error, insert the correct USB drive and power off and then power on the oven.



LOCATED ON BOTTOM OF CONTROL PANEL

## Using the Recipes

1. Press the RECIPE UP or DOWN arrows to select the desired recipe number (1-99). The TEMP, BAKE, STEAM and FAN DELAY settings are displayed.



2. Confirm that the oven is at the set baking temperature.
3. Slowly open the doors. Wait for the rack to come to a stop.
4. Load product into oven.
5. Close the doors.
6. Press START. A beeper will sound after the BAKE TIMER times out. Press STOP to silence the beeper.
7. Check product for doneness.

**IF NOT DONE** — If more bake time is needed, press the Bake Timer UP ARROW key until the desired time appears on the Minutes Set window. Press the START Key. The Timer On indicator light will start blinking.

**IF DONE** — Allow rack to stop and remove pans.

## Recipe Hints

- The oven defaults to the Recipe 0 settings when first turned on. Recipe 0 settings are as follows: Temp = 375°F, Bake Timer = 0, Steam Timer = 0, Delay Timer = 0, Recipe = 0.
- Any combination of bake settings can be manually entered for one-time custom baking operations. These settings are not saved to the recipe memory.
- If any of the baking parameters are changed in a recipe before or during a bake cycle, the oven reverts to a manual program (Recipe 0), indicating that the program has been altered. The oven will continue to operate all the recipe steps as displayed.
- The RECIPE UP and DOWN arrows have no effect while the bake cycle is in progress. However, if the BAKE TIMER has been stopped, either by pressing the STOP button or by opening the door, then pressing the RECIPE UP and Down arrows will select a new recipe and cancel the baking cycle that was in progress.
- When selecting recipes, the system will skip over unprogrammed numbers. For example, if Recipe 1 is displayed in the RECIPE window and no recipes are stored in 2, 3 and 4, then the system will skip over 2, 3 and 4. Recipe 5 will be the next recipe displayed.
- Vent opening programs the vent to open for "P10" seconds full open and then for "P11" seconds every 60 seconds.

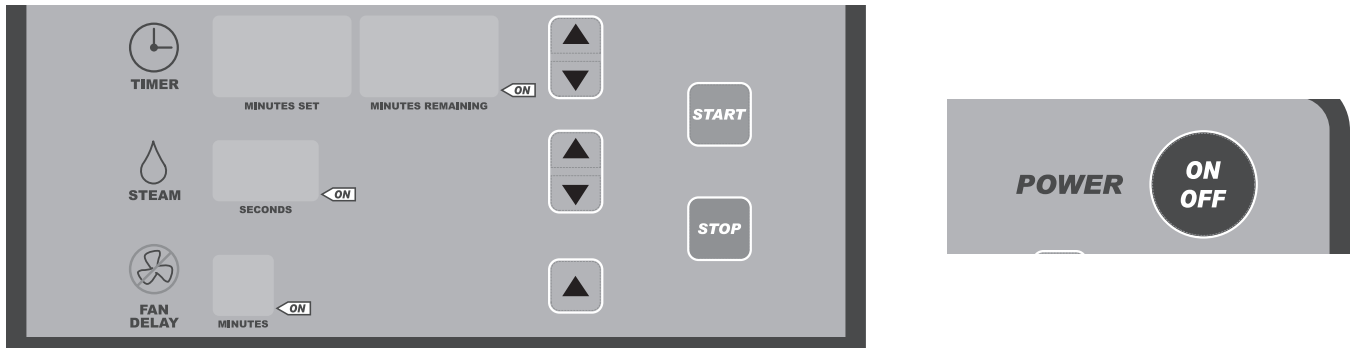
## CUSTOMIZED OPERATION

The Mini-Rack oven controls have the capability of being customized to fit your personal needs using the setup mode.

Before entering the setup mode, read all the instructions to make sure you are completely clear on what to do. If you need assistance, please call your authorized Bakery Systems service agency.

### Entering Setup Mode

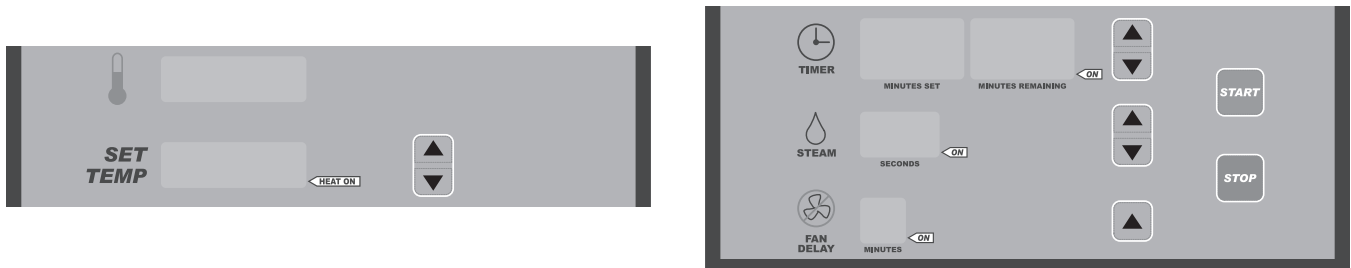
With the oven in the OFF mode, press and hold the START button. While pressing and holding the START button, press the POWER ON OFF button for 3 seconds. A code will briefly appear in the SET TEMP window. This code is related to the software version. The oven will then switch to Setup mode and P1 is displayed in the SET TEMP window.



### Changing Items in Setup Mode

The number in the SET TEMP window is the setup number. The BAKE TIMER window displays the setup item (the settings that can be changed).

1. To change the setup number, press the SET TEMP UP or DOWN arrows. The setup item will be displayed in the BAKE TIMER window.



2. To make a change in the setup item being displayed, press the BAKE TIMER UP or DOWN arrows. To adjust the setting, see Setup Guide. Do not attempt to change item numbers P4, P5 and P8. Consult your authorized Bakery Systems service agency for help with these features.
3. To exit the setup mode, press the POWER ON OFF button.

## Setup Guide

SETUP NUMBER	SETUP ITEM	DISPLAY
P0	Network Number	RS485 network number, default is 1.
P1	Maximum Temperature Setpoint	This is the maximum temperature at which the oven can be set. Range is 50°F to 525°F (10°C to 275°C). Default is 525°F.
P2	Preheat Temperature	This is the default temperature setpoint when the oven is first turned on (Program 0). The preheat temperature cannot be set higher than the value in P1 or lower than the value in P3. Range is 50°F to 525°F (10°C to 275°C). Default is 375°F.
P3	Minimum Temperature Setpoint	This is the minimum temperature at which the oven can be set. Range is 50°F to 200°F (10°C to 93°C). Default is 50°F.
P4	Temperature Offset	This value permits an offset of correction between the oven temperature display and the real baking chamber temperature. Call your authorized servicer for help with this feature. Default is 0.
P5	Heat OFF Offset	This value adjusts the temperature difference between the set point and stopping of the heating system. Call your authorized servicer for help with this feature. Default is -2
P6	Heat Difference Hysteresis	This value adjusts the temperature difference between the on temperature and off temperature of the heating system. Call your authorized servicer for help with this feature. Default is 4.
P7	Maximum Steam Time	Time set is the maximum time (in seconds) that water is supplied during the STEAM TIMER timer operation.  Maximum duration time for bake steam mode is 30 seconds of continual steam. Maximum duration time for bake steam pulse mode is 60 seconds of 5 second pulses of steam.  Default is 20.
P8	Temperature Units	The oven can be set to display temperature in Fahrenheit or Celsius. To ensure accurate temperature parameters, call your authorized servicer for help with this feature. Default is F.
P9	Timer Mode	The TIMER can be set up to display minutes set/minutes remaining or hours and minutes. Select 0 for minutes set/minutes remaining or 1 for hours and minutes. Default is 0.
P10	Vent Evacuate Time	Time set is the time (in seconds) that the vent is 100% open at the beginning of the venting cycle. Range is 0 to 180 seconds. Default is 60.
P11	Vent Open Seconds	This value is the seconds the bake chamber vent is open per 60 seconds after the vent evacuate time has expired. Range is 5 to 59. Default is 15.
P12	End of Bake Automatic Vent - Enable	This feature enables the Automatic Vent Cycle. Select 0 to disable or 1 to enable this feature (see P13 for entering time). Default is 0.
P13	End of Bake Automatic Vent Time	This is the number of minutes before the end of the bake cycle that the vent is open. Default is 1.
P14	Steam Timer Mode	The STEAM TIMER can be set up to function in Bakery mode "0" (single steam function at the beginning of step/cycle) or Food Service mode "300 to 990" seconds interval between steam functions. Default is 0.
P15	Interior Light Brightness	This value is the brightness of the interior lights. The higher the number, the brighter the lights. Range is 50 to 100. Default is 90.

SETUP NUMBER	SETUP ITEM	DISPLAY
P16	Clock Operation	This selects either 12 hours (AM/PM) clock or the 24 hour clock time display. Press the Bake Time Up button to switch between the two types of display. AP = 12 Hour Clock [Default] 24 = 24 Hour Clock
P17	Temperature Setback Time	This selects the elapsed time from the last timed bake to when the oven will lower the oven set temperature to the value set in P18. Range is 10 to 180 minutes. Default is 60.
P18	Setback Temperature	This selects the oven set temperature that the oven will change to when the temperature setback time has been exceeded in P17. Range is 50°F to 300°F (10°C to 149°C). Default is 300°F.
P19	Lights Mode	Select 1 for lights on continuously (when oven is on) or select 0 for automatic operation. Lights will turn off automatically after 30 minutes of no user activity (door opened or closed, no buttons pushed). Default is 0.
P20	Restricted Operator Mode	When restricted operator mode is selected, a recipe is selected and when the start button is pressed the operator cannot make changes to the bake time remaining, oven set temp, fan delay time or steam time. 0 = Standard (Disabled) 1 = Restricted Operator Mode (Active)
P21	Advanced Energy Savings Mode	Select 1 for Advanced Energy Saving. Forcing the oven into an advanced Auto On - Auto Off mode to conserve energy. Several steps are necessary to enable this mode. Set the Auto On time to allow the oven to preheat before the first bake time. Set the Auto Off time. Press the Auto On/Auto Off button to illuminate the Timer On/Off indicator. Set P17 & P18 to customer settings. Auto ON/OFF time is restricted when this feature is set to 1. Auto ON/OFF times can only be changed while in P21. Default is 0.
P22	Oven Operation Mode	500 = OV500/HBA [Default] 210 = OV210 310 = OV300/OV310  This must be updated to 310 when installing in a OV300/OV310 control panel. Default is 500 set for OV500 controls.
P23	External Alarm Mode	Used to decide if the external alarm relay will flash on/off or be a steady on. This is alarm is activated when a recipe's time has elapsed.  FLSH = flashing [Default] STDY = steady
P24	Test Mode Password	Test mode password, range 0x0000 to 0xFFFF. This is used by the Baxter Oven Manager application, required to put the oven into test mode. The default password value is '0000'. While editing the parameter, pressing the time down key sets the password to the default, pressing the time up key sets the password to a random value. It is highly recommended that this be a non-default value when external communications is in use for protection.
P25	Communication Mode (RS485 Serial Port)	Requires a power cycle when this is changed. 0 = 1200 baud ASCII, [default] 1 = 9600 baud NAFEM MODBUS RTU, 2 = 9600 baud ASCII 3 = 19200 baud ASCII
P26	Reserved	The default value is 0.

SETUP NUMBER	SETUP ITEM	DISPLAY
P27	Recipe Quick Time Mode	0 = Disabled. Recipes 20 to 39 shall use minutes. [default] 1 = Enabled. Recipes 20-39 shall use minutes and seconds.
P28	Show Total Time Mode	0 = Disabled. Show individual step times. [default] 1 = Enabled. Show total recipe time, the sum of all the steps.
P29	Bake Steam Pulse Mode	0 = Disabled. [default] 1 = Enabled. Steam is pulsed. 5 seconds on, 5 seconds off.  Only Applicable when steam timer mode is set to baking (P14=0)(not food service steam mode), the maximum solenoid on time range that can be set in P7 increases to 60 seconds.  If set for steam, steam is produced in 5 seconds on, 5 seconds off intervals for up to the time set in P7.  When bake steam pulse mode is disabled, P7 shall automatically be lowered to 30 seconds.
P30	Reserved	0 = Disabled. [default] 1 = Enabled.
P31	Reserved	0 = Disabled. [default] 1 = Enabled.

## ENERGY SAVING MODE

### Set back

Set back mode provides the ability to dial down the set temperature of the oven automatically when it is not being used, but needs to be in a standby mode for baking. When the oven is switched to set back temperature, the heating system remains in standby mode until it reaches that temperature. This leads to a reduction in the amount of energy used.

Parameter 17 (Temperature Setback Time) allows the user to set the desired time for the oven to sit idle before dropping the temperature to the value entered in Parameter 18 (Setback Temperature). Adjust P18 to the desired setback temperature. A setting of 250°F is recommended to keep the steam system above the water flash point.

### Advanced

Advanced energy savings (Parameter 21) mode allows the user to use the features of “Setback” as well as locking the time that the oven can be turned on or off. This will prevent the oven from being turned on too early or left on overnight. Follow the instructions for P21 (Advance energy savings mode) to set the oven for advanced energy savings mode.

The oven will automatically shut down at the pre-determined time, unless there is a bake in process.

If you need to operate the oven after the pre-determined shutoff time, turn the oven back on by pressing the ON/OFF button and immediately set the Bake Timer to at least 30 minutes and press start. If the bake timer has not been set to at least 30 minutes the oven will shut down.

**NOTE:** If you do not use the oven within 30 minutes, after timer counts down to 00:00, the oven will shut down.

## SHUTDOWN

**NOTE:** Before restarting a gas oven, the power switch and the gas burner valve must be off for a minimum of 5 minutes.

1. Remove all remaining product.

**NOTE:** Vent can be used to evacuate steam from oven.

2. Allow the oven to cool, then press the POWER ON/OFF button. If desired, quicker cool down time can be accomplished through the use of the COOL DOWN button.
3. Clean the baking chamber. See Cleaning.
4. For lengthy shutdowns, disconnect the main power and shut off the gas and water supply.

## PERFORM LED DISPLAY TEST

1. Switch the oven into the off mode.
2. Press and hold the Vent button then press and hold the POWER ON OFF button until you hear a beep and see the first test pattern.

The test will cycle through various LED tests. After the test has completed, it shall go back to showing the regular display along with the clock and it shall beep once.

# CLEANING

**⚠ WARNING** The mini-rack oven and its parts are hot. Use care when operating, servicing or cleaning the rack oven.

**⚠ WARNING** Disconnect the electrical power to the machine and follow lockout/tagout procedures.

- Allow the oven to cool.
- Clean the outside of the oven daily with a clean, damp cloth.
- Clean the rack as you would any cooking utensil. Rack may be removed from oven for ease of cleaning. (See Removing the Rack.) Use warm, soapy water and a brush. Rinse with clear water and dry with a clean cloth.
- Use care when cleaning around sensitive interior parts, such as probes, sensors or the rotating mechanism.
- Using a clean cloth and warm, soapy water, wash the stainless steel interior of the oven, rinse with clear water and dry with a clean cloth.
- Gently scrape heavy buildup off door glass. Residue can be removed with a glass cleaner when oven is cool.
- Do not use cleaners containing grit, abrasive materials, bleach, harsh chemicals or chlorinated cleaners. Do not use oven cleaners. Do not use steel wool or stainless steel cleaners on stainless steel surfaces.
- Never spray down the oven with water or steam.
- Be cautious with new or improved cleaning formulas; use only after being well tested.
- To rapidly cool down the oven, shut off the controller. Open both doors and press the VENT button. This will run the circulation blower without any heat input until the door is closed.



# MAINTENANCE

**⚠ WARNING** The mini-rack oven and its parts are hot. Use care when operating, servicing or cleaning the oven.

**⚠ WARNING** Disconnect the electrical power to the machine and follow lockout / tagout procedures.

## GENERAL

### As Needed

- Inspect the area around the oven. The area must be free and clear from combustibles. There must be no obstructions to the air flow.

### Daily

- Clean exterior. (See Cleaning.)

### Weekly

**NOTE:** Do not change air shutter settings when cleaning oven interior.

- Clean the oven interior and remove loose debris. (See Cleaning.)
- Clean the windows.

### Bi-Monthly

- Owner Preventive Maintenance Procedures.

## Preventive Maintenance

The mini-rack oven should be kept on a regular preventive maintenance schedule. Ovens require specific preventive maintenance based on usage and environmental factors. The failure to have the oven properly maintained by following recommended preventive maintenance procedures may result in higher repair costs, shortened equipment life or unsafe operating conditions.

The performance of routine preventive maintenance on any rack oven, which is the owner's responsibility, will help to ensure continued safe and reliable operation.

A preventive maintenance program is your best option for continued safe and reliable oven operation. We believe that Bakery System Service is your best choice for performing preventive maintenance.

## SERVICE AND PARTS INFORMATION

Contact your authorized Bakery Systems service agency.

## REMOVING THE RACK



5 PAN END LOAD REMOVABLE RACK

### To remove rack from oven

When oven doors are opened, rack will rotate and stop in the loading position. This is the same position for removing or reinstalling the rack.

1. Ensure that oven is cool before trying to remove the oven rack.
2. Rotate bottom plate counterclockwise to the unlocked position. Shoulder bolts do not need to be loosened or removed. See figure 1.

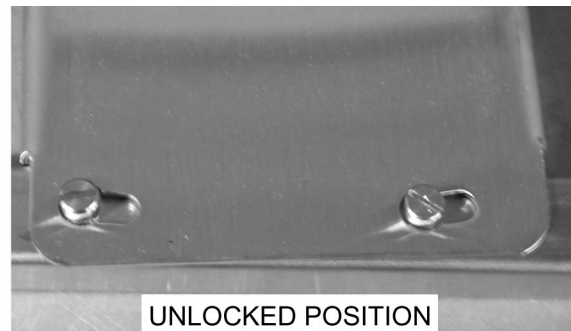
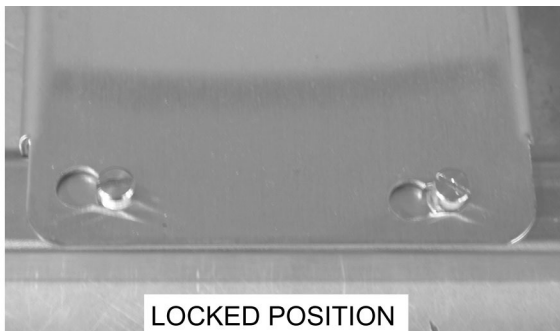
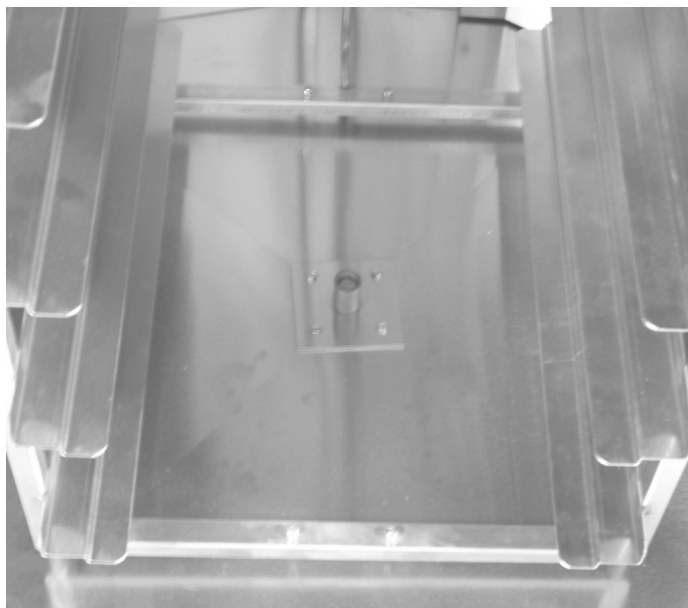


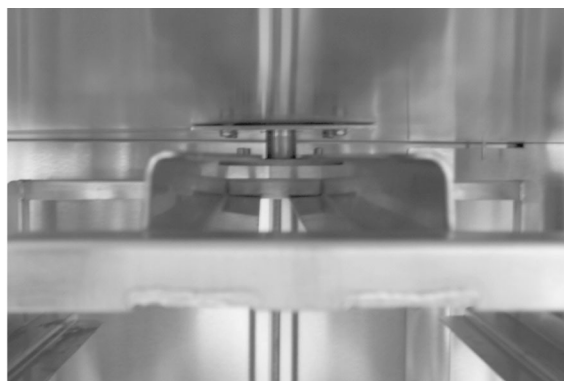
Fig. 1

3. Lift up on bottom plate and remove from the four shoulder bolts. Remove bottom plate from oven cavity. See figure 2.

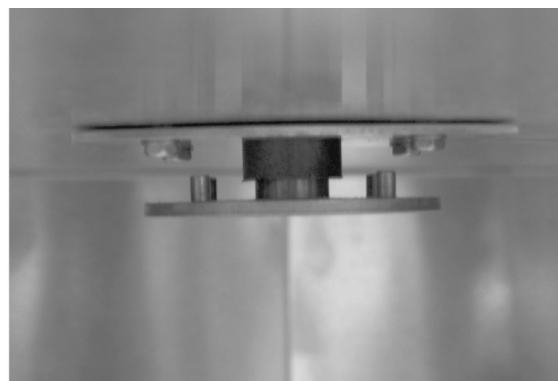


**Fig. 2**

4. Lift up on rack the top plate of the rack has cleared the locator pins. Slide the oven rack toward yourself and out of baking chamber. See figure 3.



**RACK TOP PLATE SUSPENDED  
FROM ROTATOR SHAFT**



**ROTATOR SHAFT AFTER  
RACK IS REMOVED**

**Fig. 3**

5. To reinstall oven rack, reverse removal instructions.

## UPDATE OVEN APPLICATION FIRMWARE VIA USB DRIVE (For Use on Ovens Supplied with USB Connection Package)

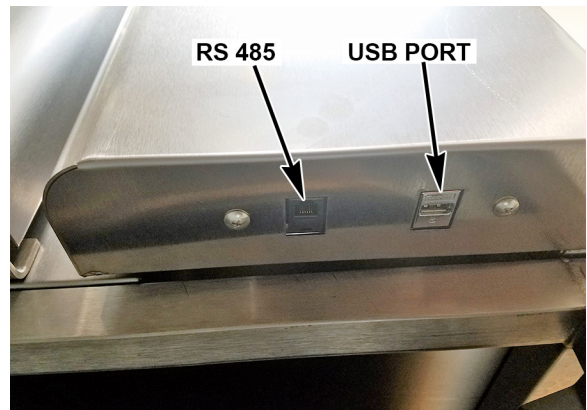
1. Switch the oven into the off mode.
2. Insert the flash drive that contains the firmware binary file [FIRMWARE.BIN] into the USB socket.
3. Press and hold the STOP button then press and hold the POWER ON OFF button, keep holding both buttons until word 'UPdt' [Update] is displayed in the clock field.

When the firmware has finished being updated the display will show UPDt-done [Update done]. You need to power off the oven, wait 10 seconds and then power on the oven to make it operable again.

If no binary file, Firmware or Recipe, is found, the display will show:

'UPdt-FAIL-USb-Err' [Update fail USB error]

To correct this error, insert the correct USB drive and power off and then power on the oven.



LOCATED ON BOTTOM OF CONTROL PANEL

# TROUBLESHOOTING

The oven has been set at the factory to bake assorted product, such as bagels, cookies and muffins. If your bake is uneven, the shutters may need to be adjusted to achieve the desired results. Contact your authorized Bakery Systems service agency for assistance.

## BURNERS WILL NOT LIGHT (GAS OVENS ONLY)

1. Press the ON/OFF button to turn the power off and wait 5 minutes.
2. Make sure the gas shutoff valve is in the ON position.
3. Press the ON/OFF button to turn the oven on.

If the oven does not light on the second attempt, turn the gas shutoff valve to the OFF position and call your authorized Bakery System service agency.

## SAFETY ALARM (STANDARD FEATURE, NO PARAMETER SETUP REQUIRED)

If the temperature at the probe is in range of 570 to 600°F for 10 seconds, the unit will do the following:

1. Shut off all features.
2. Sound an alarm.
3. Flash the OVEN TEMP display (actual temperature is displayed).
4. Display the letters 'SHdn' in the BAKE TIMER display.

**⚠ WARNING** Disconnect the electrical power to the oven and follow lockout / tagout procedures. There may be multiple circuits. Be sure all circuits are disconnected.

**⚠ WARNING** If gas oven, shut off gas. Contact your authorized Bakery Systems service office. Do not attempt to restart the oven until it has been inspected by an authorized servicer.

## ALARMS AND DISPLAY MESSAGES

Alarm or Message	Cause	Action
Controls beeps rapidly (faster beep than Baker Timer).	Temperature alert for Kosher Mode.	Turn VENT off, if activated. Gas ovens: check that burner is firing. If not firing, briefly open door and close to reset temperature control.
Display shows 'LOC OUT'.	Oven in Kosher Lock-Out Mode.	Contact your local Bakery service office.

## CIRCULATION MOTOR

To conserve energy, if there is no bake time (0) entered, the circulation blower will only run when oven is below set point and burner/heaters are on.

## RACK ROTATION

The rack will not rotate if no time "0" is set and started.

Check to make certain that doors are properly closed.

# OWNER PREVENTIVE MAINTENANCE PROCEDURES

## INTRODUCTION

This customer preventive maintenance (PM) section includes procedures to inspect for proper operation and cleaning of components. Owner Preventive Maintenance Procedures are written for gas ovens. They can also be used for electric ovens by omitting the steps that refer to components found only on gas ovens. Customer PMs should be conducted bi-monthly per OSHA Bakery Oven Inspection Standard 29 CFR 1910.263(l)(9)(ii). A convenient PM Checklist is provided at the end of this section.

**NOTE:** This PM procedure does not discuss repair or replacement of components. Upon completion of the PM procedure, you will need to contact a Bakery System service agency for any needed repairs.

### Tools Used For Inspection Procedure

- Standard set of hand tools
- Vacuum cleaner - shop vac

## PREVENTIVE MAINTENANCE PROCEDURES

**⚠ WARNING** Disconnect the electrical power to the machine and follow lockout / tagout procedures.

**⚠ WARNING** Shut off the gas before servicing the unit.

**⚠ WARNING** Certain procedures in this section require electrical test or measurements while power is applied to the machine. Exercise extreme caution at all times. If test points are not easily accessible, disconnect power and follow lockout / tagout procedures, attach test equipment and reapply power to test.

## Inspect Oven Lamps

1. Lamps should be on when oven is powered.
2. If not, replace lamps.
  - A. Twist lamp cover (Fig. 4) to disengage from lamp sockets and remove from socket.
3. Reverse procedure to install new lamp.

## Clean and Vacuum Components and Burner Area

1. Clean the burner chamber (Fig. 5) area of dust and/or lint accumulation.
  - A. Remove screw securing control panel door and swing door open to access burner chamber area.
  - B. Vacuum the burner chamber area of dust and/or lint accumulation.

**NOTE:** Individual burners may be inspected for clogs or debris without removing individual burners.

2. Check and clean all air passageways.
  - A. Clean all burner chamber air passageways of dust and/or lint accumulation.
3. Clean convection panel grill.
  - A. Clean convection panel grill (Fig. 6) of dust and/or lint accumulation.
4. Clean draft inducer housing grill guard (Fig. 7).
  - A. Access draft inducer housing on top of oven and clean grill cover of dust and/or lint accumulation.

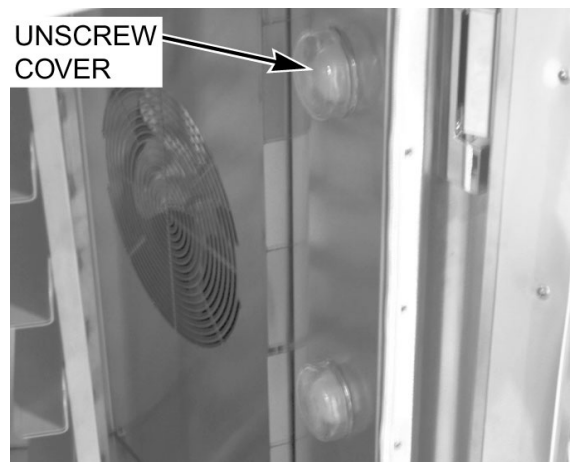


Fig. 4

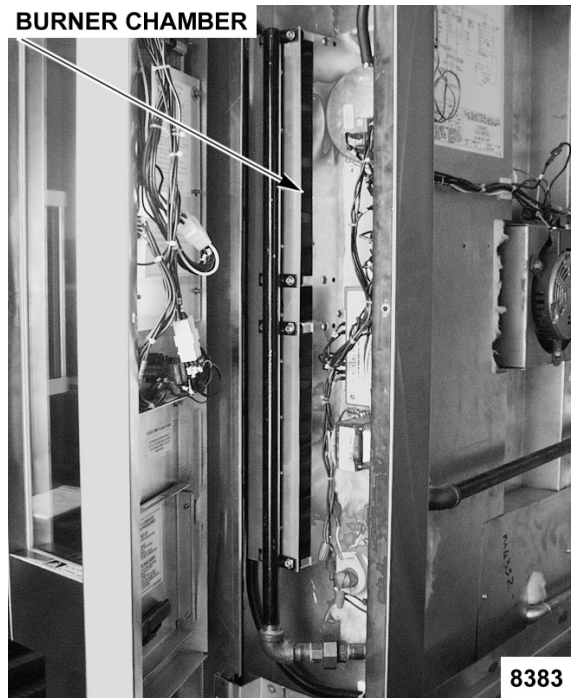


Fig. 5

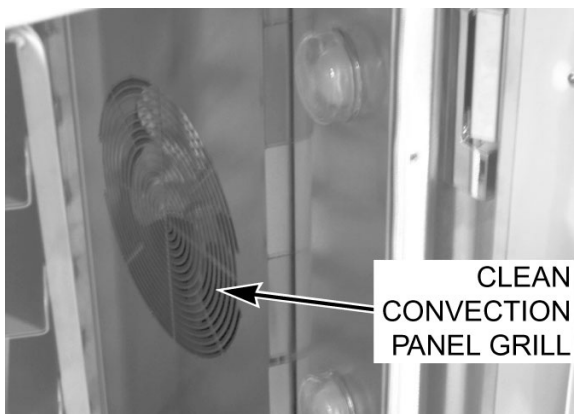


Fig. 6



Fig. 7

## Inspect Rack Lift and Rotation Assemblies

**NOTE:** Before performing rack inspection, observe condition of rack rotation belt.

1. Check rack rotation belt.
  - A. Gain access to the top of oven and loosen the screws securing rack rotation assembly cover (Fig. 8).
  - B. Lift cover from top of oven.
  - C. Observe condition of the rack rotation belt. If belt is worn or damaged, contact your local Bakery Systems service agency.
  - D. Reverse procedure to install.

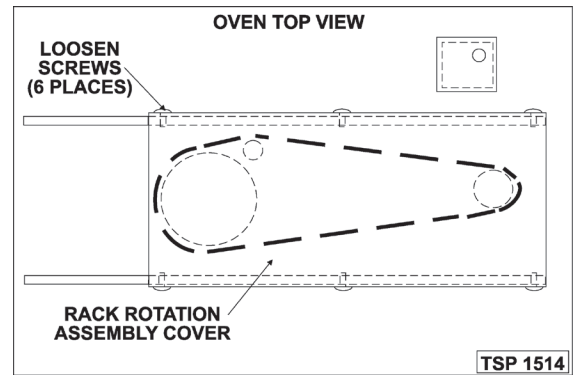


Fig. 8

2. Check rack assembly for proper operation.
  - A. Put oven into operation with customer's typical bake product load weight on rack. (If rack does not stop in the proper rack load/unload position, see Rack Adjustment.)

**NOTE:** Some undertravel or overtravel of rack position should be expected, depending on product load.

## Inspect Door Components

1. Check and/or adjust door gaskets.
  - A. While operating oven, if air (or steam) blows out from the top, sides or underneath the doors, door gasket will need to be adjusted or replaced.
  - B. If gasket needs to be replaced, contact your local Bakery Systems service agency.
2. Check door switch operation.
  - A. Turn on the oven and start a normal bake temperature.
  - B. With the oven doors closed, press START button and observe rack rotation. If no rotation, see Door Switch Adjustment.

## Inspect Air Louvers

1. Check air louvers (shutters) (Fig. 9) inside oven and tighten any loose screws.
2. Check oven interior and tighten or replace loose or missing panel screws.

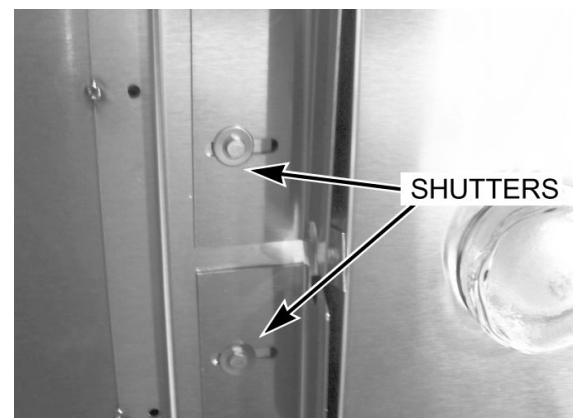


Fig. 9



## Inspect Cavity Vent

1. Check cavity vent for proper operation.
  - A. Push VENT button on control panel to open vent and push again to close vent. Vent button is located in the lower right hand corner of the control panel area.
  - B. Visually check that vent opens (Fig. 10) and closes (Fig. 11) when button is pushed. If vent does not operate, contact your authorized Bakery Systems service agency for service.

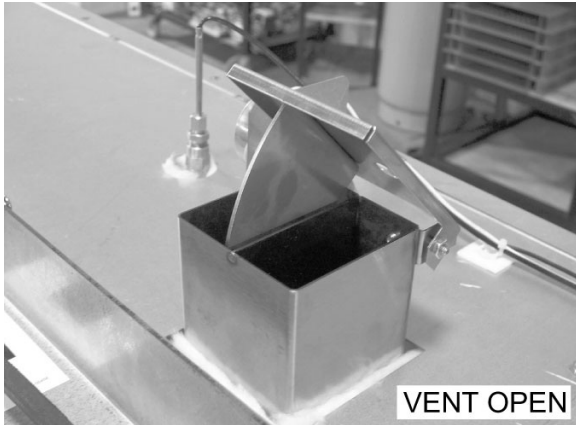


Fig. 10

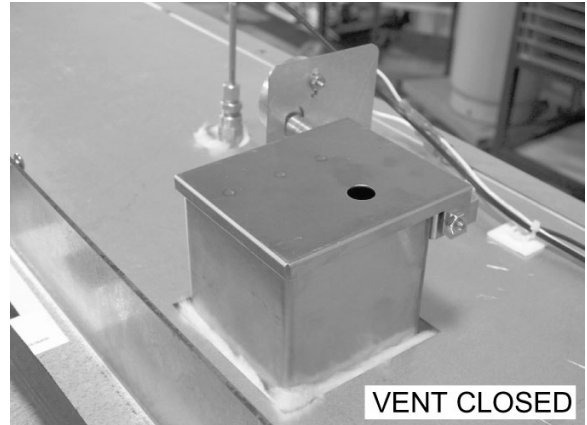


Fig. 11

## Visually Inspect Electrical Connections

1. Remove screw securing control panel door and swing door open to access burner compartment area.
2. Inspect all wiring connections for discoloration. If discoloration is visible, contact your local Bakery Systems service office.

## Verify Ignition Module Safety Lockout Functions (Gas Only)

1. Verify ignition module safety lockout functions.
  - A. Turn on the oven and close the doors.
  - B. Turn off the gas supply to the oven.
  - C. Set the oven control to call for heat and make sure convection fan is running.
  - D. Remove screw securing the control panel door and swing the door open to access the burner compartment area.
  - E. Observe LED on ignition module. After trying to light the burner, the module should lockout. (See following chart.)
  - F. Turn gas supply to oven back on.
  - G. Set the oven control for heat, and make sure convection fan is running and the burner has established a flame.
  - H. Turn off the gas supply to the oven.
  - I. Observe LED on ignition module (Fig. 12). The module should lockout. (See following chart.)

LED DIAGNOSTIC INDICATOR CODES	
LED	CODE
LED "OFF"	No Fault
LED "ON"	Control Fault
'1' Flash	Air Flow Fault
'2' Flash	Flame Fault No Call for Heat
'3' Flash	Ignition Module Lockout

- J. If the results have been obtained, proceed to next preventive maintenance procedure.
- K. If the results have not been obtained, contact your authorized Bakery Systems service agency for service.

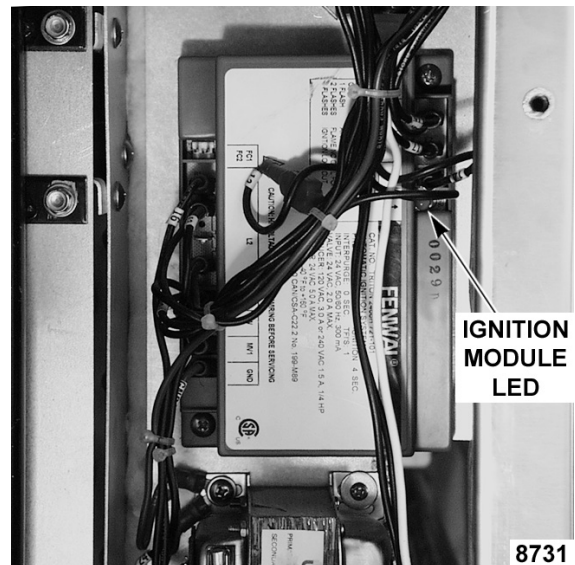


Fig. 12

2. Verify operation of draft inducer pressure switch.

- A. Turn incoming power off to oven.
- B. Remove screw securing control panel door and swing door open to access burner compartment area.
- C. Loosen hose clamp (Fig. 13) and remove vacuum tube from the vacuum switch.

**NOTE:** Some ovens may have rectangular-shaped vacuum switches.

- D. Reconnect incoming power to oven and turn oven on.
- E. Set oven to heat and press START.
- F. The burners should not come on at this time.
- G. If the burners do not come on, proceed to next preventive maintenance procedure.
- H. If the burners do come on, contact your local Bakery Systems service office.
- I. Reverse the procedure to install.

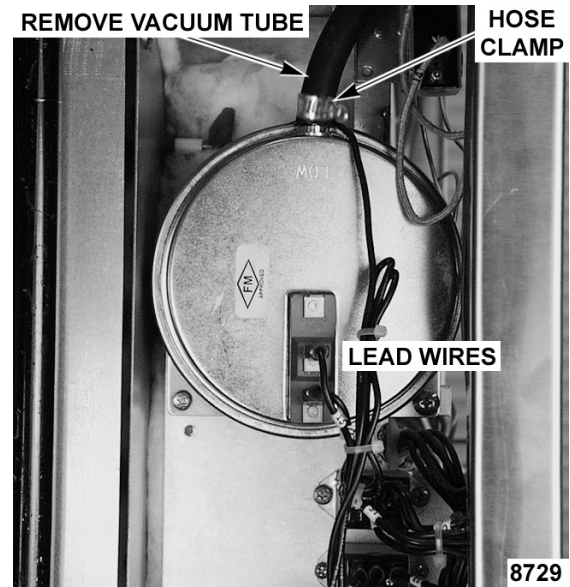


Fig. 13

**NOTE:** Use normally open, common terminals and low vacuum port for the vacuum switch setup.

3. Verify operation of draft inducer (stack fan) pressure switch.

- A. Set oven for heat.
- B. Disconnect tubing from exhaust vent collar. Burner should go out.
- C. Reconnect tubing and burner should establish a flame.
- D. If the results have been obtained, proceed to next preventive maintenance procedure.
- E. If the results have not been obtained, contact your local Bakery Systems service office.

**Verify Operation of Steam**

1. Check steam system for proper operation.

- A. Turn on the water supply.
- B. Turn on the oven and set to normal bake temperature.
- C. Allow to cycle three times to stabilize temperature.
- D. Set control to call for steam.
- E. Observe operation. If steam is not observed, contact your local Bakery System service office.

**NOTICE** After completion of the owner PM Procedure, you will need to contact an authorized Bakery System service agency for any needed repairs.

Keep a copy of the Owner Preventive Maintenance Checklist for your records.

# PREVENTIVE MAINTENANCE CHECKLIST

## BAKERY RACK OVENS - GAS



**CHECK FOR PROPER OPERATION AND ADJUSTMENT  
CLEAN OR ADJUST AS NEEDED**

✓ = PROCESS COMPLETED

	DRO2G	DRO2GH	HO210G	OV210G	HO300G	OV300G	OV310G	HBAXG	BXAXG										* OSHA ONLY
Clean and vacuum components and burner areas	●	●	●	●	●	●	●	●	●										
Lubricate components as necessary	●	●	●	●	●	●	●	●	●										
Rack lift and rotation assemblies	●	●	●	●	●	●	●	●	●										
Door components	●	●	●	●	●	●	●	●	●										●
Steam system inspection	●	●	●	●	●	●	●	●	●										
Burner and heat exchanger inspection	●	●	●	●	●	●	●	●	●										●
Gas valve leakage and supply pressure test	●	●	●	●	●	●	●	●	●										●
Air louvers	●	●	●	●	●	●	●	●	●										
Cavity vent	●	●	●	●	●	●	●	●	●										
Electrical connections	●	●	●	●	●	●	●	●	●										
Verify operation of ignition module and lockout functions	●	●	●	●	●	●	●	●	●										●
Verify and adjust manifold gas pressure settings with oven heating	●	●	●	●	●	●	●	●	●										●
Record combustion analysis results	●	●	●	●	●	●	●	●	●										●
Control calibration and steam operation	●	●	●	●	●	●	●	●	●										

Serial Number \_\_\_\_\_

PM Type       Annual       Semi-Annual       \* OSHA ONLY

Type of Gas       Natural Gas       Propane

Gas pressure setting (manifold) \_\_\_\_\_ "W.C.

Combustion analysis      O<sub>2</sub> \_\_\_\_\_ %      CO<sub>2</sub> \_\_\_\_\_ %      CO Air Free \_\_\_\_\_ ppm

Stack Draft \_\_\_\_\_ "W.C.

Ticket Number \_\_\_\_\_

Servicing Office \_\_\_\_\_

Location \_\_\_\_\_

Store No. \_\_\_\_\_

Technician \_\_\_\_\_

Date Completed \_\_\_\_\_

\_\_\_\_\_  
(Customer Signature)

\_\_\_\_\_  
(Customer Name)

\_\_\_\_\_  
(Address)

\_\_\_\_\_  
(City/State/Zip)

\* **OSHA ONLY:** This is a safety check only & does not include cleaning of control compartment, combustion blower motor, draft inducer, or other associated assemblies. Replacement of the ignition probe and/or flame sense probe may be required for proper operation after removing the burner and is not included in the OSHA Inspection price.

Copy and Distribute as Needed