



SERVICE MANUAL

V SERIES FOOD HOLDING & TRANSPORTATION CABINETS AND BANQUET CARTS

MODELS:

VB90	ML-126548
VB96	ML-126550
VB150	ML-126552
VBP5I	ML-138030
VBP7I	ML-126358
VBP13I	ML-126359
VBP15I	ML-126360
VBP33	ML-138075
VBP77I	ML-126361
VBS15	ML-138033
VHA9	ML-138072
VHA18	ML-138073
VHDP5	ML-138035
VHFA9	ML-138070
VHFA18	ML-138071
VHP3	ML-126343
VHP7	ML-126344
VHP8	ML-126345
VHP15	ML-126346
VHP20	ML-126347



This manual is prepared for the use of trained Vulcan Service Technicians and should not be used by those not properly qualified.

This manual is not intended to be all encompassing. You should read, in its entirety, the repair procedure you wish to perform to determine if you have the necessary tools, instruments, and skills required to perform the procedure.

Reproduction or other use of this Manual, without the express written consent of Vulcan, is prohibited.

For additional information on Vulcan-Hart or to locate an authorized parts and service provider in your area, visit our website at www.vulcanhart.com

IMPORTANT FOR YOUR SAFETY

THIS MANUAL HAS BEEN PREPARED FOR PERSONNEL QUALIFIED TO INSTALL ELECTRICAL EQUIPMENT, WHO SHOULD PERFORM THE INITIAL FIELD START-UP AND ADJUSTMENTS OF THE EQUIPMENT COVERED BY THIS MANUAL.

READ THIS MANUAL THOROUGHLY BEFORE OPERATING, INSTALLING OR PERFORMING MAINTENANCE ON THE EQUIPMENT.

- △ WARNING** Failure to follow instructions in this manual can cause property damage, injury, or death.
- △ WARNING** Always Perform the Lockout/Tagout procedure before removing any sheet metal panels or attempting to service this equipment. Failure to comply with this procedure can cause property damage, injury, or death.
- △ WARNING** Improper installation, adjustment, alteration, service, or maintenance can cause property damage, injury, or death.
- △ WARNING** Do NOT operate this equipment without properly placing and securing all covers and access panels.
- △ WARNING** In the event of a power failure, do not attempt to operate this device.
- △ WARNING** Electrical and grounding connections must comply with the applicable portions of the National Electric Code and/or all local electric codes.
- △ WARNING** Appliances equipped with a flexible electric supply cord, are provided with a three-prong grounding plug. It is imperative that this plug be connected into a properly grounded three-prong receptacle. If the receptacle is not the proper grounding type, contact an electrician. Do NOT remove the grounding prong from the plug.

TABLE OF CONTENTS

IMPORTANT FOR YOUR SAFETY	1
GENERAL	3
INTRODUCTION	3
INSTALLATION	3
OPERATION	3
CLEANING	3
ELECTRICAL REQUIREMENTS	3
SERIAL NUMBER LOCATION	3
TOOLS REQUIRED	3
SPECIFICATIONS	4
COMPONENT LOCATION	5
CONTROLS	5
ELEMENTS	5
PROBE	5
POWER CORD	5
CONTROLS (VHFA9, VHFA18)	6
POWER CORD WRAP (VHFA9, VHFA18)	6
FAN (VHFA9, VHFA18)	6
COMPONENT FUNCTION	7
CONTROLS	7
ELEMENTS	7
PROBE	7
CONTROLS (VHFA9, VHFA18)	7
FAN	8
ELEMENTS (VHFA9, VHFA18)	8
PROBE	8
LOCKOUT / TAGOUT PROCEDURE	8
COMPONENT REMOVAL AND REPLACEMENT	9
COVER REMOVAL	9
THERMOMETER	9
THERMOSTAT	10
THERMOSTAT CALIBRATION	10
DUAL LIGHT INDICATOR	11
FAN	11
ON / OFF SWITCH	12
ELEMENT	12
POWER CORD	13
DOOR AND HINGE	13
DOOR GASKET	14
SERVICE & PARTS INFORMATION	14
TROUBLE SHOOTING	15
WIRE DIAGRAMS	16 – 19

GENERAL

INTRODUCTION

Vulcan-Hart Food Holding and Transportation Cabinets and Banquet Carts are produced with quality workmanship and material. Proper installation, usage and maintenance will result in many years of satisfactory performance.

Before performing maintenance on the cabinet/cart, thoroughly read this manual and carefully follow all instructions in the order given.

This manual is applicable only to models listed on the cover page. Procedures in this manual will apply to all models unless specified. Illustrations can be of any model unless the illustration needs to be model-specific.

INSTALLATION

Refer to the Installation and Operation Manual for detailed installation instructions.

OPERATION

Refer to the Installation and Operation Manual for detailed operating instructions.

CLEANING

Refer to the Installation and Operation Manual for detailed cleaning instructions.

ELECTRICAL REQUIREMENTS

All Vulcan-Hart 110/120 volt cabinets are equipped with an 8 ft. (2.4m) cord and NEMA 5-15 or 5-20 plug as standard equipment.

All Vulcan-Hart 208/240 volt cabinets are equipped with an 8 ft. (2.4m) cord and

NEMA 6-15 or 6-20 plug as standard equipment.

SERIAL NUMBER LOCATION

The Serial Number and Model Number for the unit are located on the Serial Data Plate, which is located by the electrical connection. (Fig. 1)

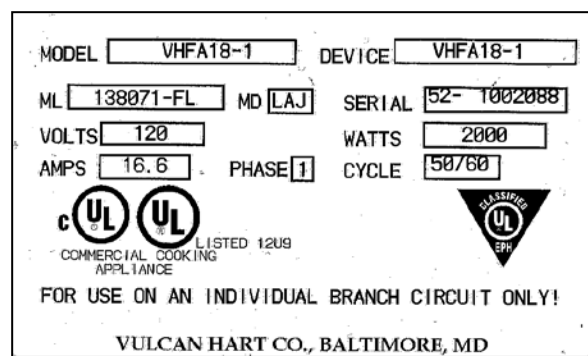

Fig. 1 - Serial Data Plate

TOOLS

Standard

- Standard set of hand tools.
- Volt-Ohm-Meter (VOM) with AC current tester with sensitivity of at least 20,000 Ohms per volt.
- Standard Thermometer
- Pop Rivet Gun and 3/16" closed end rivets for Models VHFA9 and VHFA18.

Special

- CLR Treatment Kit to remove Calcium/Lime/Rust from cabinet. (Contact Authorized Vulcan-Hart Servicer.)

SPECIFICATIONS							
MODEL NO.	HEIGHT IN (mm)	DEPTH IN (mm)	WIDTH IN (mm)	SHIPPING WT. Lb. (kg)	VOLTS	WATTS	AMPS
VB90	71.75" (1822)	42.75" (1086)	31.75" (806)	242# (110 kg)	120	2000	16.6
VB96	62" (1575)	29" (737)	51.5" (1308)	435# (197 kg)	120	2000	16.6
VB150	73" (1854)	29" (737)	61.25" (1556)	590# (268 kg)	120	2000	16.6
VBP5I	31.5" (800)	33.75" (857)	28.25" (718)	170# (77 kg)	120	1200	10
VBP7I	37.75" (959)	33.75" (857)	28.25" (718)	230# (104 kg)	120	1200	10
VBP13I	57.25" (1454)	33.75" (857)	28.25" (718)	340# (154 kg)	120	1200	10
VBP15I	67" (1702)	33.75" (857)	28.25" (718)	360# (163 kg)	120	1200	10
VBP33	43.5" (1105)	30.75" (782)	25.25" (643)		120	1200	10
VBP77I	72.5" (1842)	31.75" (806)	24.5" (622)	400# (182 kg)	120	2400	20
VBS7	37.625" (956)	30.25" (781)	23.75" (584)	195# (90 kg)	120	1200	10
VBS15	66" (1676)	30.25" (781)	23.75" (584)	315# (144 kg)	120	1200	10
VHA9	43.5" (1105)	30.75" (782)	25.25" (643)		NA	NA	NA
VHA18	71" (1804)	30.75" (782)	25.25" (643)		NA	NA	NA
VHDP5	62.25" (1582)	38" (966)	24.75" (629)	370# (169 kg)	120	2000	16.7
VHFA9	43.5" (1105)	30.75" (782)	25.25" (643)	190# (87 kg)	120	1200	10
VHFA18	71" (1804)	30.75" (782)	25.25" (643)	225# (102 kg)	120	2000	16.7
VHP3	23.5" (597)	23.75" (604)	18" (457)	80# (36.6 kg)	120	600	5
VHP7	28.5" (724)	25" (635)	18.25" (464)	80# (36.3 kg)	120	600	5
VHP8	31.5" (800)	25" (635)	18.25" (464)	90# (40.9 kg)	120	600	5
VHP15	61.25" (1556)	26.75" (680)	21.25" (540)	196# (89 kg)	120	1200	10
VHP20	61" (1549)	29" (737)	39.5" (1003)	264# (120 kg)	120	1200	10

COMPONENT LOCATION

MODELS: VHP3, VHP7, VHP8, VHP15, VHP20, VBP5I, VBP7I, VBP13I, VBP15I, VBP77I, VBS7, VBS15, VHDP5, VB90, VB96, VB150, VBP33

CONTROLS

CONTROL - FRONT VIEW

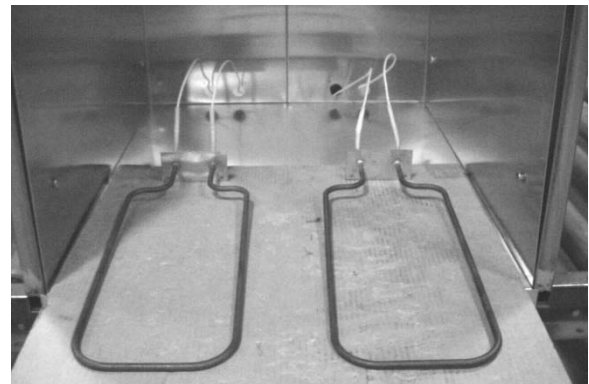
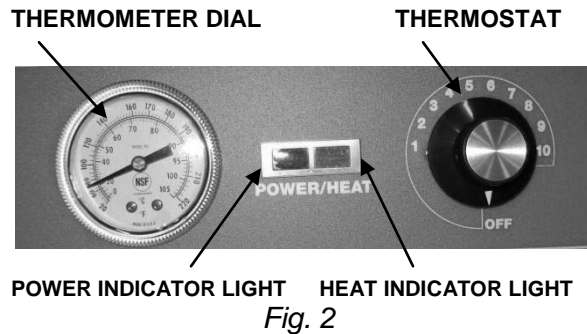

CONTROL - INSIDE VIEWS

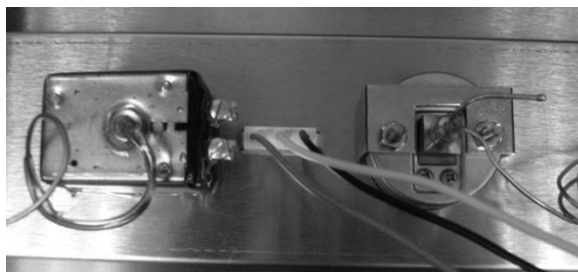
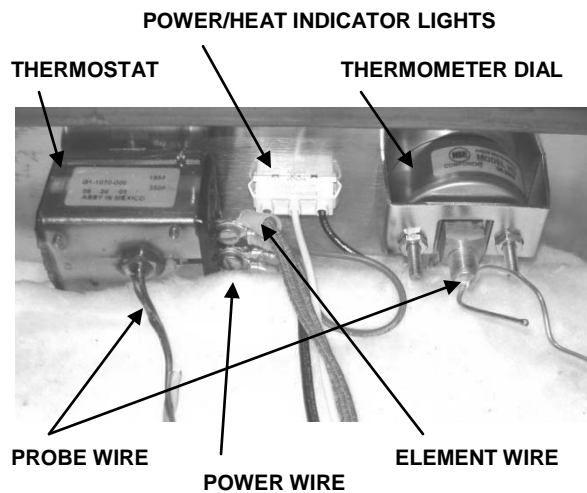

PROBE

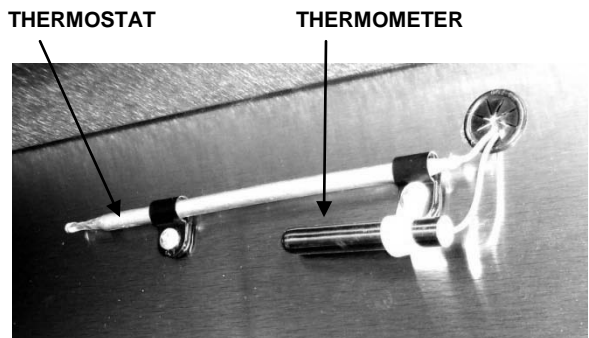

POWER CORD

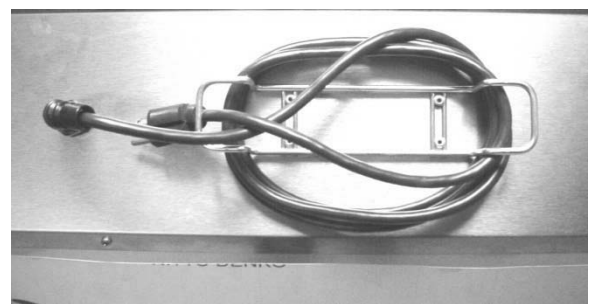

ELEMENTS

MODELS: VHFA9, VHFA18

CONTROLS

CONTROL - FRONT VIEW

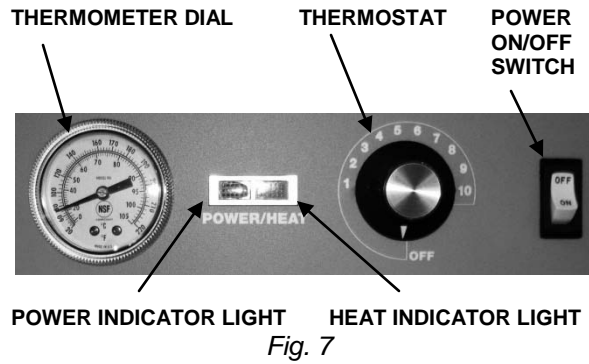

CONTROL - INSIDE VIEW

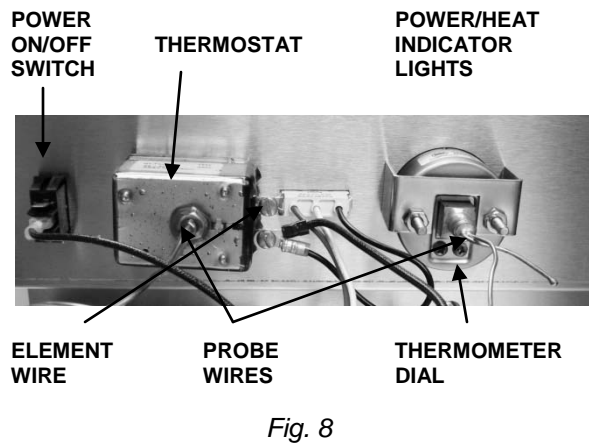

POWER CORD WRAP



FAN

FAN - FRONT VIEW

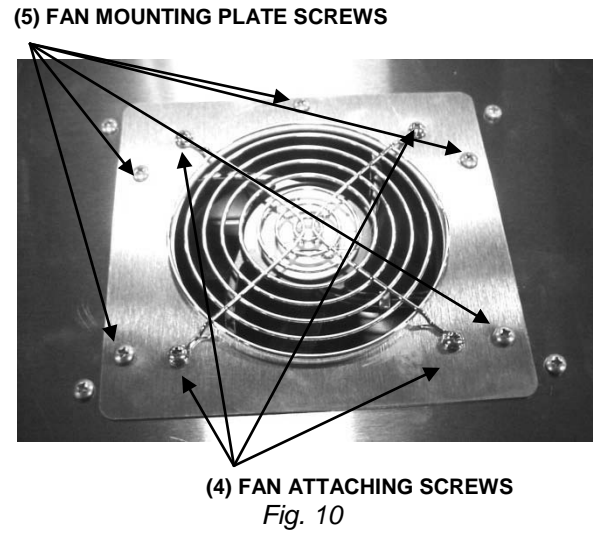

FAN - INSIDE VIEW (HOUSING)

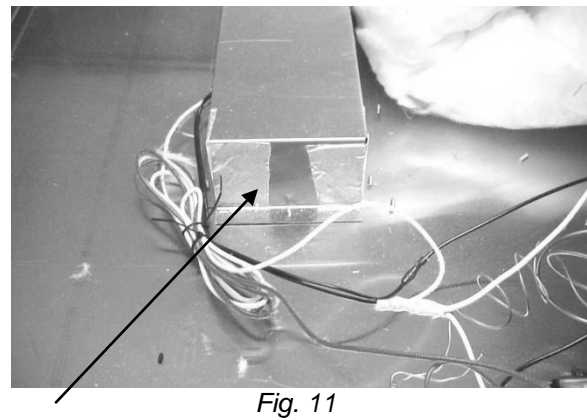

FAN

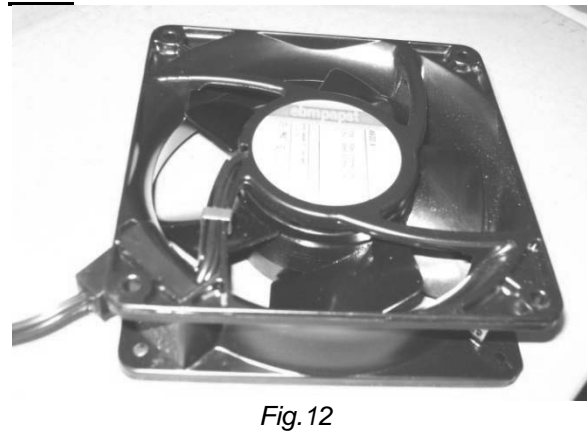

COMPONENT FUNCTION

MODELS: VHP3, VHP7, VHP8, VHP15, VHP20, VBP5I, VBP7I, VBP13I, VBP15I, VBP77I, VBS7, VBS15, VHDP5, VB90, VB96, VB150, VBP33

CONTROLS

THERMOMETER: Indicates interior temperature. (Fig. 2)

THERMOSTAT: Turns power on to heating element. Thermostat setting is from 1 to 10. The greater the thermostat setting number, the higher the temperature.

Thermostat Setting	Approximate Temperature
1	100°F (37°C)
2	110°F (43°C)
3	120°F (49°C)
4	130°F (54°C)
5	140°F (60°C)
6	150°F (66°C)
7	160°F (71°C)
8	170°F (77°C)
9	180°F (82°C)
10	190°F (88°C)

POWER INDICATOR LIGHT: Indicates unit is plugged in. As long as the cabinet is plugged in, the *red light* will stay on.

HEAT INDICATOR LIGHT: Indicates element is heating. Light will stay on as long as the heating elements are engaged. Once the predetermined temperature is achieved, the heating elements will begin to cycle. During this period the *amber light* will turn on and off.

ELEMENTS

ELEMENTS: Heat element/elements located at the bottom of cabinet.

PROBE

THERMOSTAT: Controls the output temperature of the heating element. Once the output temperature of the heating element reaches the set temperature, the thermostat sensor removes power from the heating element.

THERMOMETER: Senses the temperature in the cabinet.

MODELS: VHFA9, VHFA18

CONTROLS

THERMOMETER: Indicates interior temperature. (Fig. 7)

THERMOSTAT: Turns power on to heating element. Thermostat setting number, the higher the temperature.

POWER INDICATOR LIGHT: Indicates unit is plugged in and **ON/OFF SWITCH** is in the ON position. The *red light* will stay on until the ON/OFF Switch is in the OFF position.

HEAT INDICATOR LIGHT: Indicates element is heating. Light will stay on as long as the heating elements are engaged. Once the predetermined temperature is achieved, the heating elements will begin to cycle. During this period, the *amber light* will turn on and off.

POWER ON/OFF SWITCH: Supplies electrical power to the cabinet and turns on the fan. The cabinet will not have power unless switch is in the ON position.

MODELS: VHFA9, VHFA18 (continued)**FAN**

The fan is located on top of the unit. The fan and air tunnel provide even heat distribution. The fan is turned on and off with the POWER ON/OFF SWITCH.

ELEMENTS

There are 2 heating elements located at the bottom of the cabinet.

PROBE

THERMOSTAT: Monitors/sensors the output temperature of the heating elements. Once the output temperature of the heating element reaches the set temperature, the thermostat sensor removes power from the heating element.

THERMOMETER: Senses the temperature in the cabinet.

LOCKOUT / TAGOUT PROCEDURE

△WARNING Always perform the **LOCKOUT / TAGOUT PROCEDURE** before removing any sheet metal panels or attempting to service this equipment.

FAILURE TO COMPLY WITH THIS PROCEDURE CAN CAUSE PROPERTY DAMAGE, INJURY OR DEATH.

The Lockout / Tagout Procedure is used to protect personnel working on an electrical appliance. Before performing any type of maintenance or service on an electrically operated appliance, follow these steps:

1. In electrical box, place unit's circuit breaker into OFF position.
2. Place a lock or other device on electrical box cover to prevent someone from placing circuit breaker ON.
3. Place a tag on electrical box cover to indicate that unit has been disconnected for service and power should not be restored until tag is removed by maintenance personnel.
4. Disconnect unit power cord from electrical outlet.
5. Place a tag on cord to indicate that oven has been disconnected for service and power should not be restored until tag is removed by maintenance personnel.

COMPONENT REMOVAL AND REPLACEMENT

COVER REMOVAL

The Cover must be removed to access the Thermostat, Thermometer, Lights, and Wiring.



WARNING Disconnect the electrical power to the unit and follow LOCKOUT/TAGOUT PROCEDURES.

1. Locate and remove the two (2) screws holding the top cover to the left side.
2. Locate and remove the two (2) screws holding the top cover to the right side.
3. Locate and remove the two (2) screws holding the top cover to the back.
4. Remove the cover.

(Reverse the above steps to install.)

THERMOMETER



WARNING Disconnect the electrical power to the unit and follow LOCKOUT/TAGOUT PROCEDURES.

1. Remove the Cover.
2. Identify and remove the screw that holds the thermometer sensing bulb on the inside of the cabinet. *It will be mounted to the top of the cabinet.* (Fig. 13)

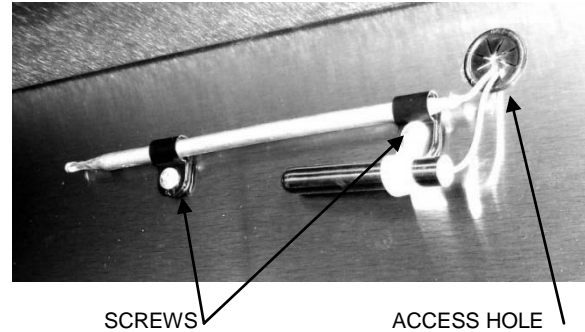

Fig. 13

4. Pull the thermometer bulb through the access hole located in the top of the cabinet.
5. Remove the retaining nuts that hold the thermometer to the housing located on the back of the control panel. (Fig. 14)



THERMOMETER
RETAINING NUTS

Fig. 14

6. Remove the thermometer by pushing it from the rear through the control panel.
7. Install the replacement thermometer by reversing the above steps.
8. Reconnect the cabinet to its power source and test.

THERMOSTAT



⚠ WARNING Disconnect the electrical power to the unit and follow **LOCKOUT/TAGOUT PROCEDURES**.

1. Remove the Cover.
2. Identify and remove the two (2) screws that hold the thermostat sensing bulb on the inside of the cabinet. *It will be mounted to the top of the cabinet.* Push/pull the thermostat bulb through the access hole located in the top of the cabinet
3. Turn the black Thermostat Knob to the “**OFF**” position.
4. Remove the black thermostat knob from the control panel by using an allen wrench to loosen the two (2) set screws that hold it to the thermostat stem. (Fig. 15)

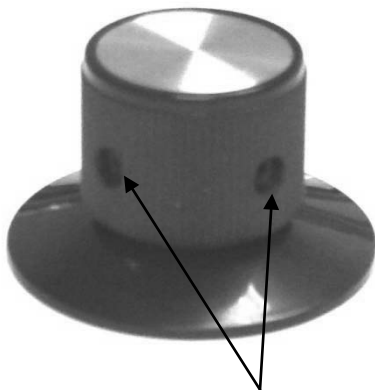

THERMOSTAT KNOB SET SCREWS

Fig. 15

5. Refer to the wiring diagram to identify the electrical leads that connect to the thermostat.
6. Disconnect the wire leads connected to the thermostat.

7. Remove the two (2) screws on the front of the control panel that hold the thermostat in place and remove the thermostat.
8. Install the replacement thermostat temperature sensing probe by reversing the steps above.
9. Reconnect the cabinet to its power source and test.

THERMOSTAT CALIBRATION



⚠ WARNING Disconnect the electrical power to the unit and follow **LOCKOUT/TAGOUT PROCEDURES**.

1. Turn thermostat knob to **Off** position.
2. Loosen set screws and remove knob.
3. Using a small screw driver, turn the screw in the center of the thermostat stem: “**clockwise to Decrease**” temperature or “**counter-clockwise to Increase**” temperature. (Fig. 16)

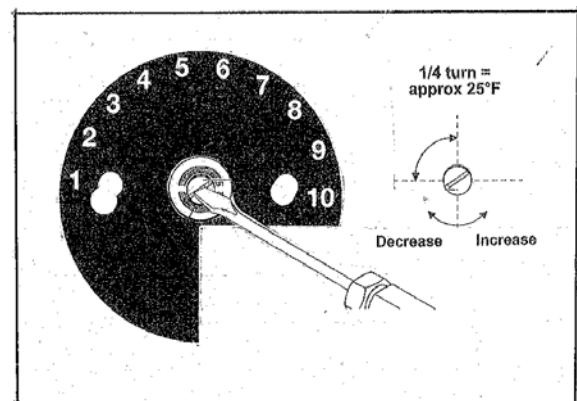

Fig. 16

5. Replace knob and tighten set screws.
6. Reconnect the cabinet to its power source and test.

DUAL LIGHT INDICATOR



WARNING Disconnect the electrical power to the unit and follow LOCKOUT/TAGOUT PROCEDURES.

1. Remove the cover.
2. Refer to the wiring diagram to identify the electrical leads that connect to the indicator light.
3. Disconnect the wire leads to the indicator light.
4. Depress the side mounted retaining clips on the indicator light housing and remove the light from the front of the control panel.
5. Install the replacement indicator light by pushing it into the control panel opening and the retaining clips snap into place.
6. Complete the installation by reversing the above steps.
7. Reconnect the cabinet to its power source and test.

FAN

VHFA9, VHFA18



WARNING Disconnect the electrical power to the unit and follow LOCKOUT/TAGOUT PROCEDURES.

1. Remove the five (5) screws from the fan mounting plate. (Fig. 10)
2. Unplug the fan power cord. (Fig. 17)

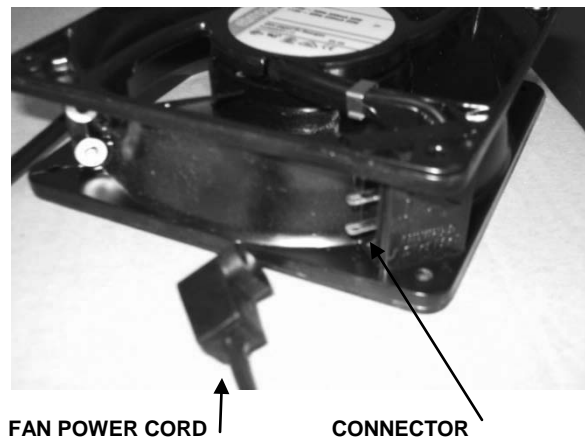

Fig. 17

3. Remove the four (4) fan attaching screws and remove fan. (Fig. 10)
4. Install the replacement fan and complete the installation by reversing the above steps.
5. Reconnect the cabinet to its power source and test.

ON / OFF SWITCH

VHFA9, VHFA18



⚠ WARNING Disconnect the electrical power to the unit and follow **LOCKOUT/TAGOUT PROCEDURES**.

1. Remove the cover.
2. Refer to the wiring diagram to identify the electrical leads that connect to the switch.
3. Disconnect the wire leads to the switch.
4. Depress the top/bottom mounted retaining clips on the switch housing and remove it from the front of the control panel.

NOTE: To expedite removal – cutting the retaining clips off with a knife or snips will make removal of the switch easier. (The switch will not be reusable if this is done.)

5. Install the replacement switch by pushing it into the control panel opening and the retaining clips snap into place.
6. Complete the installation by reversing the above steps.
7. Reconnect the cabinet to its power source and test.

ELEMENT



⚠ WARNING Disconnect the electrical power to the unit and follow **LOCKOUT/TAGOUT PROCEDURES**.

1. Open the door to the cabinet.

2. Remove the bottom mounted element cover.
3. Remove the two (2) retaining screws that hold each element to the mounting plate and the one (1) screw for the element clip. (Fig. 18)

MOUNTING PLATE RETAINING SCREWS

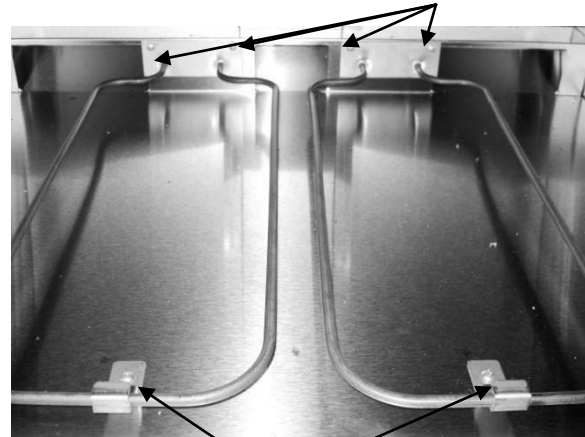

ELEMENT CLIP SCREWS

Fig. 18

4. Gently pull the element away from the inner liner of the cabinet until the electrical lead wires are exposed. (Fig. 19 & 20)



Fig. 19

5. Disconnect the element wires at the electrical lead connectors.

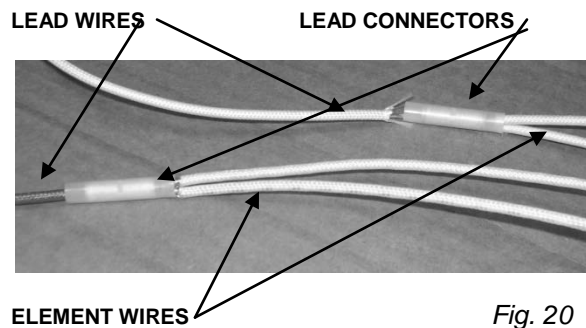

Fig. 20

6. Reconnect the replacement element to the lead wires with **New** wire connectors.
7. Gently tuck the residual wire back through the wire housing hole until the backing plate is lined up with the mounting holes, and is flush against the inner liner of the cabinet.
8. Complete the installation by reversing the above steps.
9. Reconnect the cabinet to its power source and test.

6. Install the replacement cord by inserting the cord and threaded portion of the strain relief through the opening in the cover.
7. Complete the installation by reversing the above steps.
8. Reconnect the cabinet to its power source and test.

DOOR INSTALLATION



⚠ WARNING Disconnect the electrical power to the unit and follow **LOCKOUT/TAGOUT PROCEDURES**.

1. Using a flat head screwdriver, pry the hinge cover away from the hinge until it snaps out.

Caution: Use care not to scratch the hinge cover. Look for the small indentation on the inner portion of the hinge cover, as the location to pry the cover.

2. Remove the three (3) phillips head screws that attach the hinge to the door. Remove six (6) phillips head screws to replace hinge. (Fig. 21)

POWER CORD



⚠ WARNING Disconnect the electrical power to the unit and follow **LOCKOUT/TAGOUT PROCEDURES**.

1. Remove the cover.
2. Refer to the wiring diagram to identify the electrical leads that connect to the power cord.
3. Disconnect the wire leads to the power cord.
4. Unscrew the retaining nut that holds the power cord strain relief to the cover.
5. Remove the power cord.

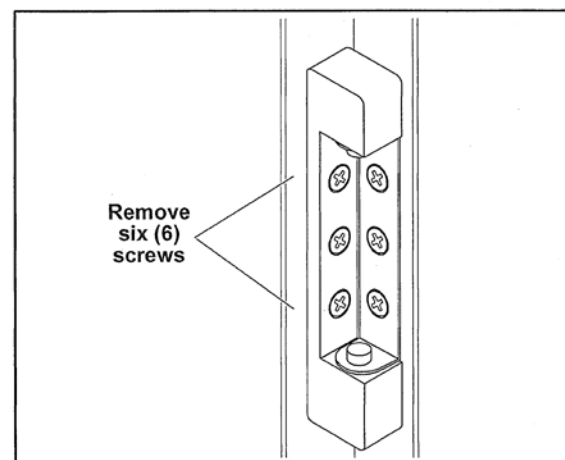

Fig. 21

3. Remove the old door. *You may need to open the latch.*
 4. Remove the phillips head screws that attach the latch to the door.
Note: *There may be anywhere from two (2) to four (4) screws on the latch.*
 5. If necessary, drill the new holes using a #19 drill bit (or 11/16" bit.)
Note: *When drilling holes into the cabinet frame, use a long drill bit (2") as you need to drill through both sides of the 1" frame tubing.*
 6. Apply a thread locker material to any screw/screws you are re-installing.
 7. Using a screw gun, attach the door to the hinge and latch to the door.
 8. Close the door and check for gaps between the door and gasket. Adjust as necessary. Adjust the latch, if necessary.
1. Remove the old gasket by pulling it out of the aluminum J-channel. Verify that all gasket and adhesive has been completely removed before proceeding to step 3.
 2. Install the new gasket by starting at one end and pressing the gasket into the J-channel. A slotted screw driver may be needed to fully seat the gasket. You can also use "Pam Cooking Spray."
Note: *Be careful not to puncture the gasket with the screw driver.*
 3. Repeat until all gaskets have been replaced.
 4. Using a "food grade" sealant / adhesive, seal the corners to eliminate any gaps, and to prevent the gasket from sliding in the J-channel.
 5. Wipe away any excess sealant.
Note: *Allow 30 minutes for the sealant / adhesive to cure.*
 6. When the sealant/adhesive has cured, close the door and check for gaps between the door and gasket. Adjust the gasket extension, if necessary.

DOOR GASKET

Before removing the old gasket, verify that the replacement gasket(s) are the correct size and length.



⚠ WARNING Disconnect the electrical power to the unit and follow LOCKOUT/TAGOUT PROCEDURES.

SERVICE & PARTS INFORMATION

To obtain Service and Parts information concerning this model, contact Vulcan-Hart Service Department at the address listed on the front cover of this manual or refer to our website: www.vulcanhart.com for a complete listing of Authorized Service and Parts depots.

Customer Service	1-800-814-2028
Technical Service	1-800-814-2028
Service Parts	1-800-814-2028

When calling for service, have the model number and serial number available

TROUBLESHOOTING

SYMPTOMS	POSSIBLE CAUSES	REMEDY
Cabinet not operating.	Cabinet not connected to power source.	Connect cabinet to power source.
	Cabinet lighted power switch not turned ON.	Turn lighted power switch ON.
	No power.	Check circuit breaker. Check GFCI.
GFCI or Ground Fault Circuit Indicator tripped	Moisture problem. Shorted element. Pinched/damaged wire. Damaged power cord.	Dry moisture problem. Check/replace element. Check/replace wire. Check/replace power cord.
Cabinet is connected to power source, switch is ON, circuit breaker is ON but cabinet is not heating.	Heating element is faulty.	Check/replace heating element.
	Thermometer is faulty.	Check/replace thermometer.
	Thermostat is faulty.	Check/replace thermostat.
Lighted power switch ON but not lit.	Power switch faulty.	Check/replace power switch.
	Dual light indicator faulty.	Check/replace Dual Light Indicator.
Cabinet does not heat properly.	Defective: element, thermometer, thermostat, switch.	Check/replace: element, thermometer, thermostat, power switch.
	Thermostat requires adjustment.	Perform thermostat calibration.
	Door not properly sealed.	Check/adjust door and hinge. Check/replace door gasket.
Fan not operating. (VHFA9, VHFA18 only)	Power switch not ON.	Turn power switch on.
	Fan faulty.	Check/replace fan.

WIRING DIAGRAMS

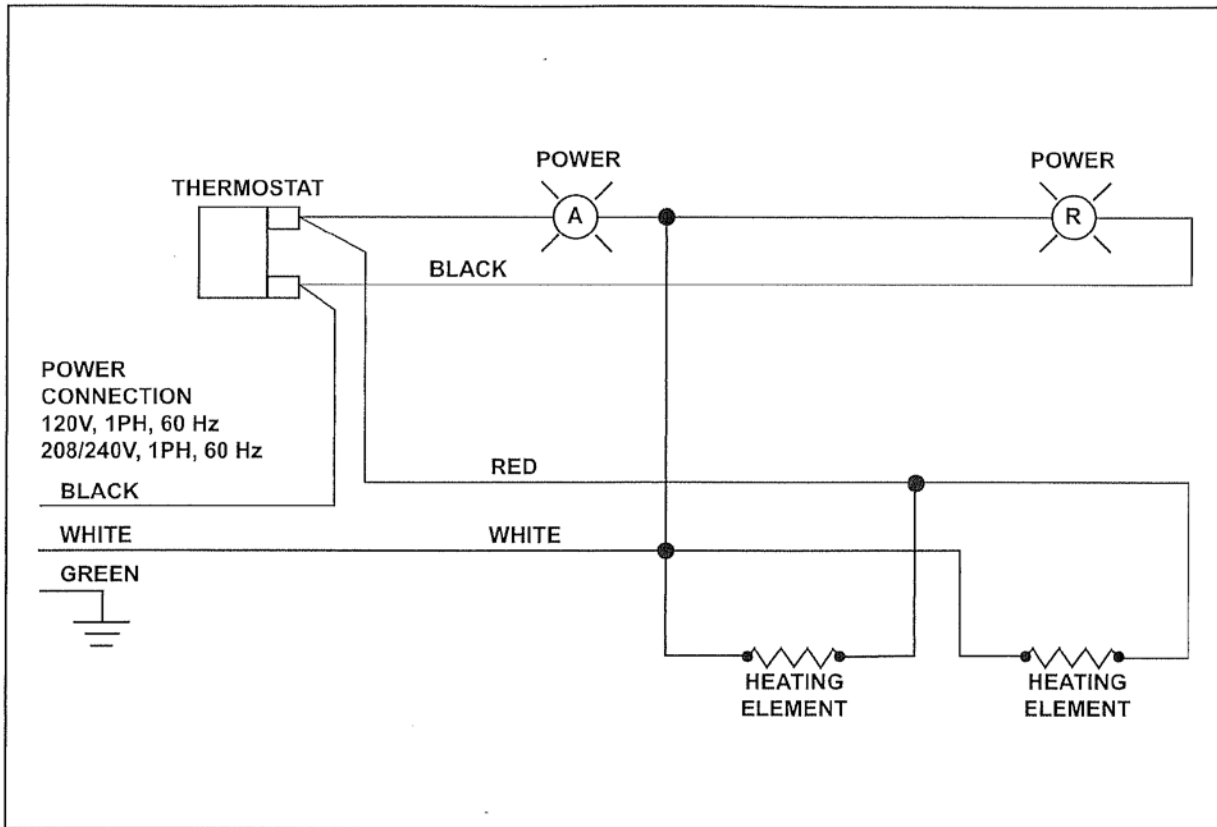

**VB90, VB96, VB150, VBP5I, VBP7I, VBP13I, VBP15I, VHP15, VHP20, VBS7, VBS15
 VBP33**
Wiring Diagram

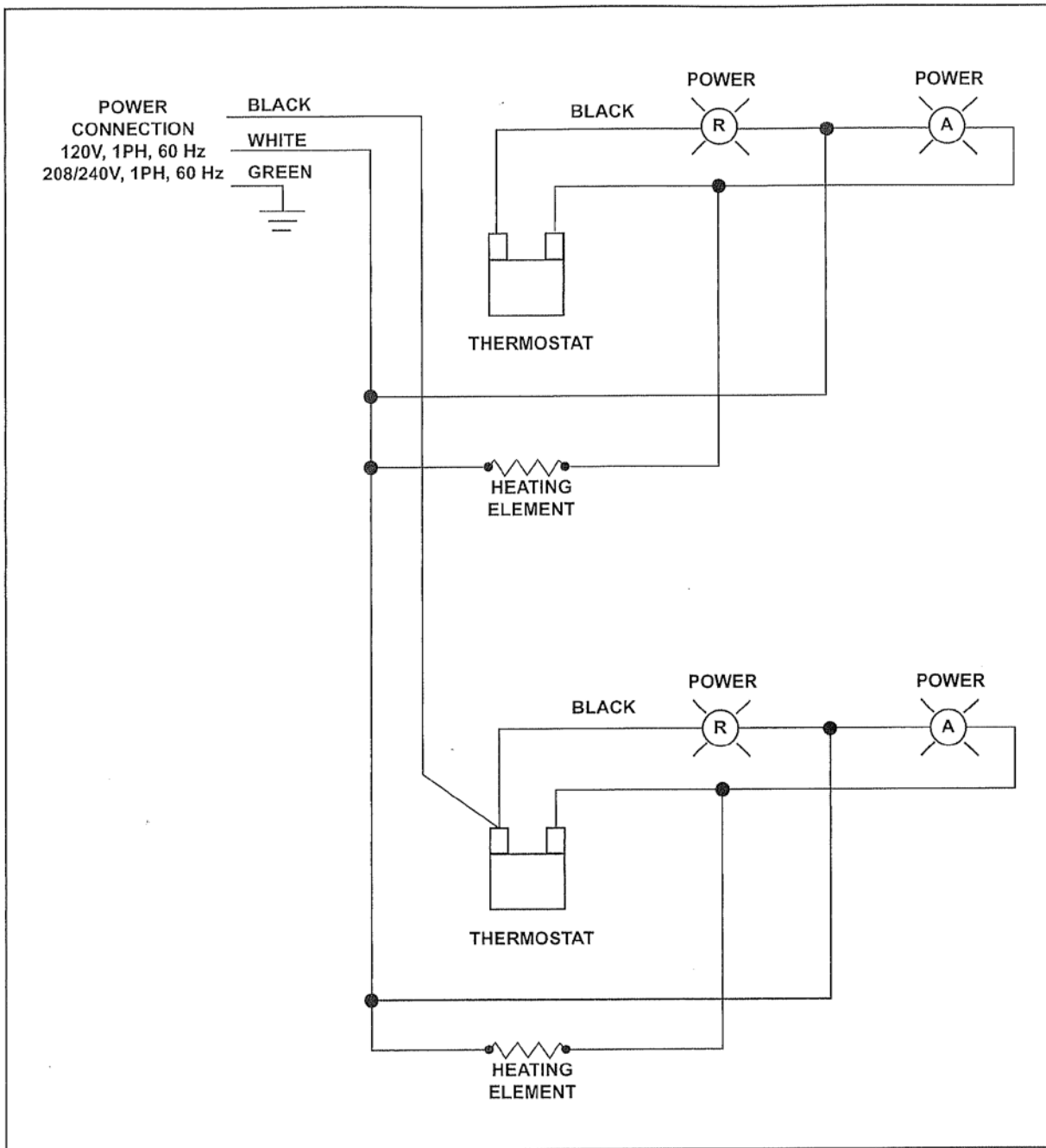

VBP771 Wiring Diagram

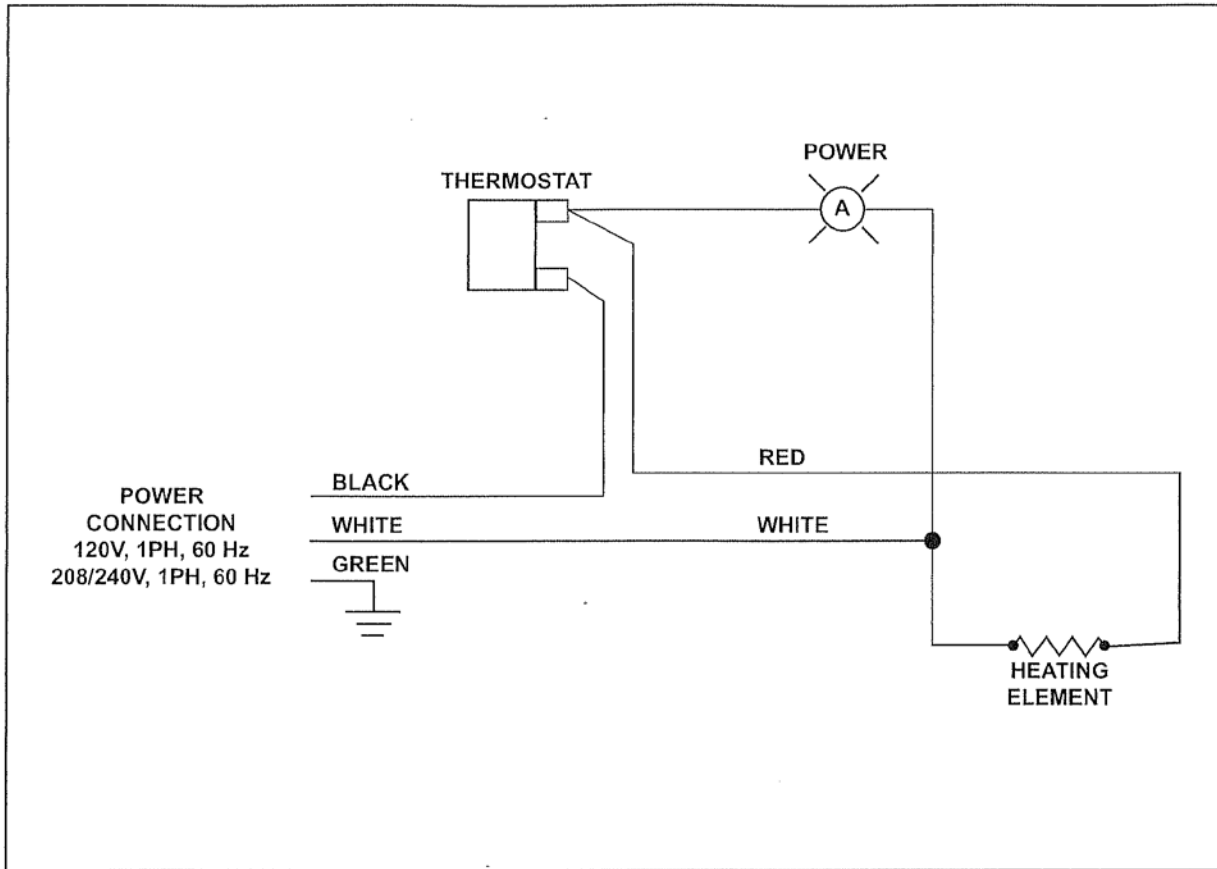

VHP3, VHP7, VHP8 Wiring Diagram

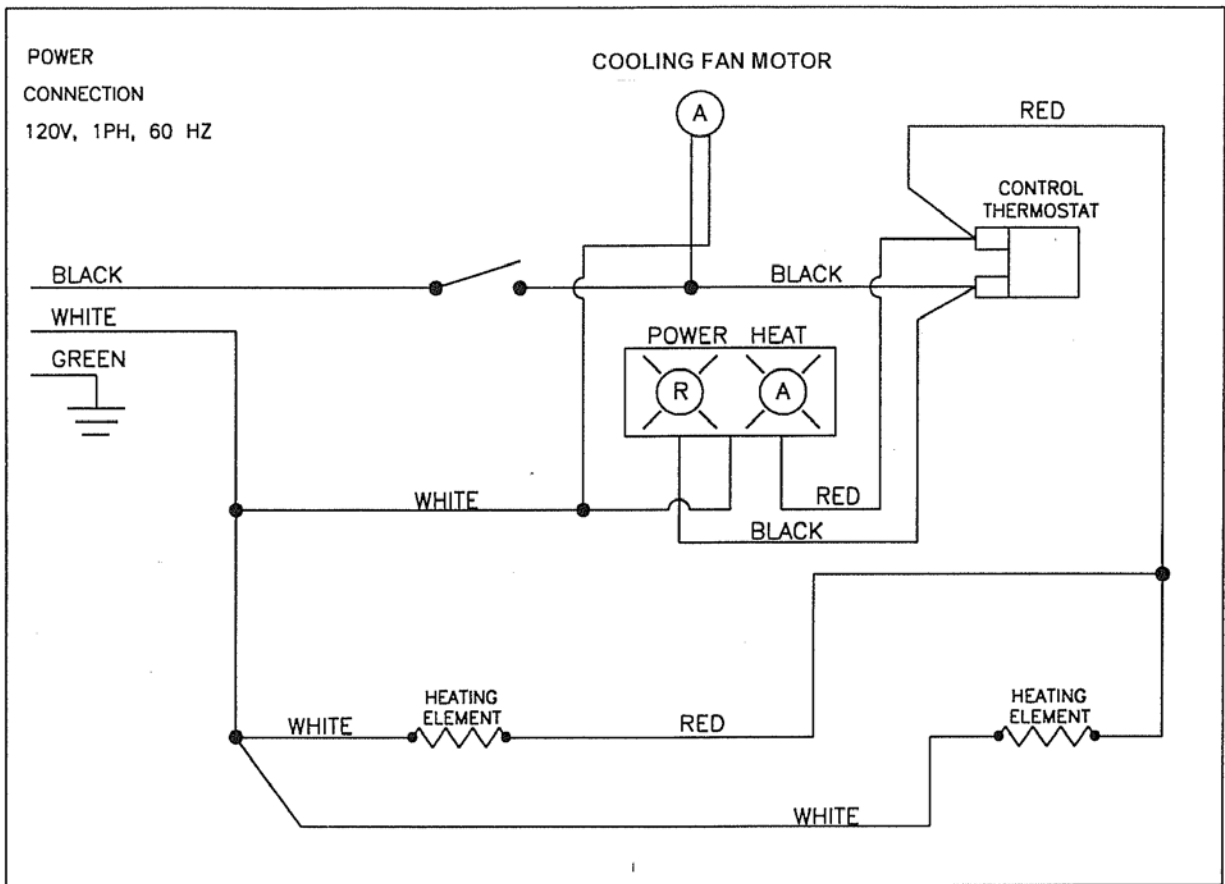

VHFA9, VHFA18 Wiring Diagram