

*Thank you for your purchase!*



## 9 FT Round Umbrella

### ASSEMBLY INSTRUCTIONS

#### **Before You Begin:**

Please identify all component parts and hardware pieces required before your begin. Carefully remove all of the components from the packaging and set aside for assembly. Assemble on a soft surface to prevent scratching during assembly.

#### **Caution:**

Tighten all components securely before use. Failure to do so may result in personal injury. DO NOT use any sharp objects to open plastic wrapped components as damage to product or components may result.

#### **Warning:**

CHOCKING HAZARD -Small Parts. Adult Assembly Required.

DO NOT ALLOW CHILDREN TO CLIMB ON FURNITURE



---

Customer Service email: [CustomerExperience@belnickinc.com](mailto:CustomerExperience@belnickinc.com) | Phone:866-552-2810

GM-402003-RED-GG | GM-402003-TAN-GG

## PARTS

A		1 PC
---	---	------

B		1 PC
C		1 PC

## STEPS

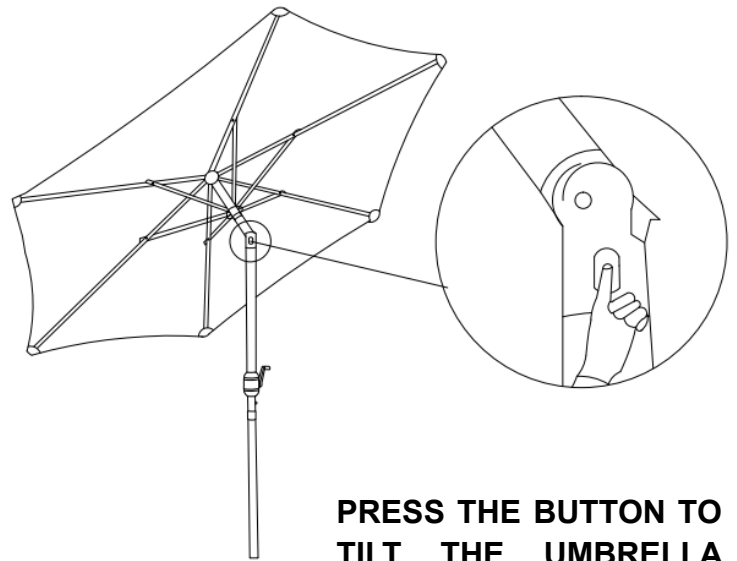
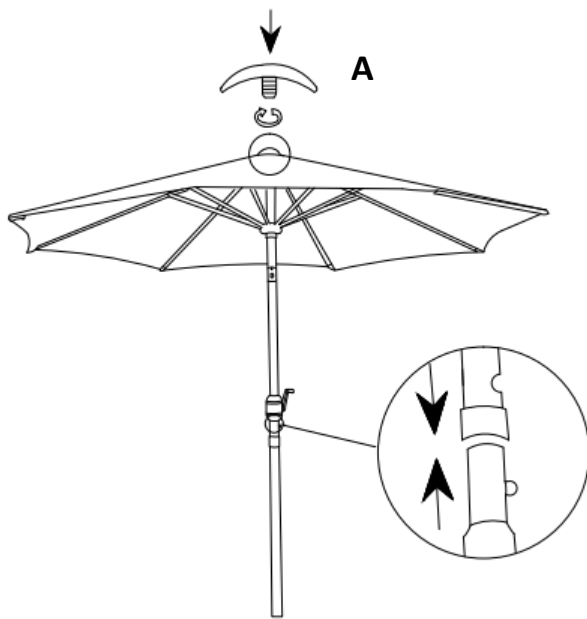

**PRESS THE BUTTON TO  
TILT THE UMBRELLA  
POSITION**

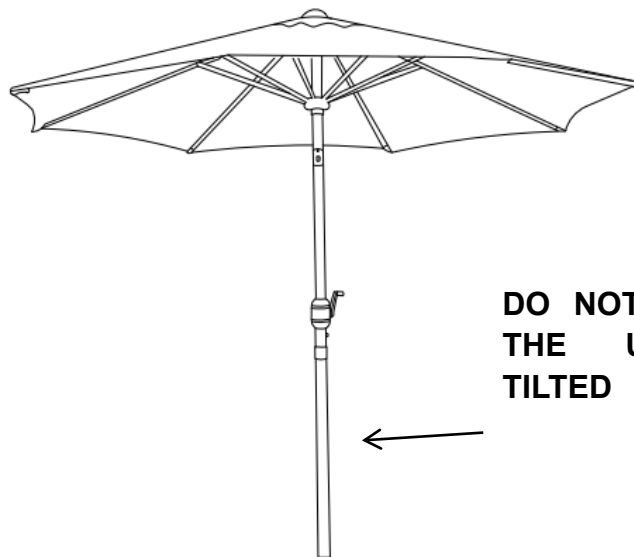

**DO NOT OPEN OR CLOSE  
THE UMBRELLA WHEN  
TILTED**

.....  
*Thank you for your purchase!*

*Thank you for your purchase!*

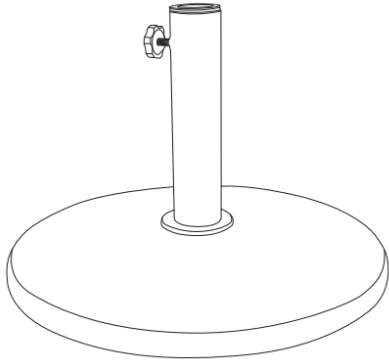

## **19.3 Inch Umbrella Base**

### **ASSEMBLY INSTRUCTIONS**

#### **Before You Begin:**

Please identify all component parts and hardware pieces required before your begin. Carefully remove all of the components from the packaging and set aside for assembly. Assemble on a soft surface to prevent scratching during assembly.

#### **Caution:**

Tighten all components securely before use. Failure to do so may result in personal injury.

DO NOT use any sharp objects to open plastic wrapped components as damage to product or components may result.

#### **Warning:**





CHOCKING HAZARD -Small Parts. Adult Assembly Required.

DO NOT ALLOW CHILDREN TO CLIMB ON FURNITURE

.....  
Customer Service email: [CustomerExperience@belnickinc.com](mailto:CustomerExperience@belnickinc.com) | Phone: 866-552-2810

GM-UB19-BZ-GG

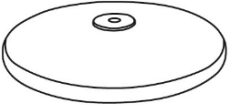
**PARTS**

A		1 PC	D		1 PC
B		1 PC	E		3 PCS
C		1 PC			

**STEPS**

Step 1:

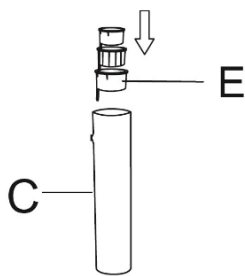

**Adapter tips:**

Small:  $\phi$  30-  $\phi$  35mm  
 Medium  $\phi$  40-  $\phi$  45mm  
 Large:  $\phi$  48-  $\phi$  50mm

Embed (E) in (C), please make sure the adapter(E) is suitable for the umbrella pole diameter, remove the smaller part (E).

Step 2:

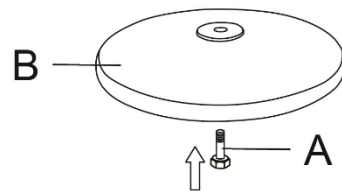

Turn (B) on its side and insert (A) into the hole.

Step 3:

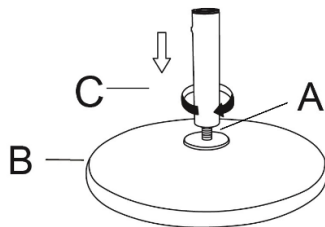

Connect(C) and (A) and rotate (C) to tighten.

Step 4:

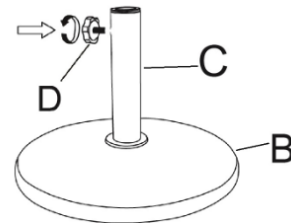

Insert the umbrella pole, then tighten (D) to fix the umbrella pole in place.



*Thank you for your purchase!*