



**IMPORTANT FOR FUTURE REFERENCE**

Please complete this information and retain this manual for the life of the equipment:

Model #: \_\_\_\_\_

Serial #: \_\_\_\_\_

Date Purchased: \_\_\_\_\_

**ENGLISH**

**Installation & Operation Manual**  
**REDUCED OIL VOLUME**  
**FRYING SYSTEM**

Covering Model

SGLVRF



## TO THE PURCHASER, OWNER AND STORE MANAGER

Please review these warnings prior to posting them in a prominent location for reference.

### TO THE PURCHASER

Post in a prominent location the instructions to be followed in the event that an operator smells gas. Obtain this information from your local gas supplier.

### FOR YOUR PROTECTION

DO NOT store or use gasoline or other flammable vapors and liquids in the vicinity of this or any other appliance. Do not spray aerosols in the vicinity of this appliance when it is in operation.

### WARNING

Improper installation, adjustment, operation, alteration, service or maintenance can cause property damage, injury or death. Read the installation, operating and maintenance instructions thoroughly before installing, operation, servicing this appliance.

### WARNING

Installation, maintenance and repairs should be performed by a Pitco Authorized Service and Parts (ASAP) company technician or other qualified personnel. Installation, maintenance or repairs by an unauthorized and unqualified personnel will void the warranty.

### WARNING

Installation and all connections must be made according to local codes in force. In the absence of local codes in North America, the installation must conform with the National Fuel Gas Code, ANSI Z223.1/NFPA 54 or the Natural Gas and Propane Installation Code CSA B149.1 as applicable. In Australia, the appliance must be installed in compliance with AS/NZS 5601.

### WARNING

During the warranty period if a customer elects to use a non-original part or modifies an original part purchased from Pitco and/or its Authorized Service and Parts (ASAP) companies, this warranty will be void. In addition, Pitco and its affiliates will not be liable for any claims, damages or expenses incurred by the customer which arises directly or indirectly, in whole or in part, due to the installation of any modified part and/or received from an unauthorized service center.

### WARNING

This appliance, when installed, must be electrically grounded in accordance with local codes, or in the absence of local codes, with the National Electrical Code, ANSI/NFPA 70, or the Canadian Electrical Code, CSA C22.2, as applicable and the hose must comply with AS/NZS 1869 and be class B or D.

### WARNING

Adequate means must be provided to LIMIT the movement or this appliance without depending on the gas or electrical cord connection. Single appliances equipped with legs must be stabilized by installing anchor straps. All appliances equipped with casters must be stabilized by installing restraining chains.

### WARNING

An appliance equipped with casters and a flexible gas line must be connected to the gas supply with a quick disconnect device. In North America, this quick disconnect must comply with ANSI Z24.41. In Australia, the quick disconnect must comply with AS 4627.

## **TO THE PURCHASER, OWNER AND STORE MANAGER**

**Please review these warnings prior to posting them in a prominent location for reference.**

### **WARNING**

**DO NOT** alter or remove structural material on the appliance to accommodate placement under a ventilation hood.

### **WARNING**

If the appliance is equipped with a power cord and it is damaged, it must be replaced by a Pitco Authorized Service and Parts (ASAP) company technician, or a similarly qualified person in order to avoid a hazard.

### **WARNING**

The power supply must be disconnected before servicing, maintaining or cleaning this appliance.

### **WARNING**

The appliance is **NOT** jet stream approved. **DO NOT** clean the appliance with a water jet.

### **WARNING**

**DO NOT** attempt to move this appliance or transfer hot liquids from one container to another when the unit is at operating temperature or filled with hot liquids. Serious personal injury could result if skin comes in contact with the hot surfaces or liquids.

### **WARNING**

**DO NOT** use an open flame to check for gas leaks!

### **WARNING**

**DO NOT** sit or stand on this appliance. The appliance's front panel, tank, splash back, tank cover, workshelf, drain board is not a step. Serious injury could result from slipping, falling or contact with hot liquids.

### **WARNING**

**NEVER** use the appliance as a step for cleaning or accessing the ventilation hood. Serious injury could result from slips, trips or from contacting hot liquids.

### **WARNING**

The oil/liquid shortening level should **NOT** fall below the minimum indicated level line at any time. The use of old oil/liquid shortening can be dangerous as it will have a reduced flash point and be more prone to surge boiling.

### **WARNING**

The contents of the crumb catch and/or filter pan of any filter system must be emptied into a fireproof container at the end of the frying operation each day. Some food particles can spontaneously combust into flames if left soaking in certain oil/liquid shortening materials.

### **WARNING**

Completely shut the appliance down when oil/liquid shortening is being drained from the appliance. This will prevent the appliance from heating up during the draining and filling process. Serious injury can occur.

### **WARNING**

This appliance is intended for indoor use only.

### **WARNING**

**DO NOT** operate appliance unless all panels and access covers are attached correctly.

### **WARNING**

It is recommended that this appliance be inspected by a qualified service technician for proper performance and operation on a yearly basis.

## **TO THE PURCHASER, OWNER AND STORE MANAGER**

**Please review these warnings prior to posting them in a prominent location for reference.**

### **WARNING**

There is an open flame inside this appliance. The unit may get hot enough to set nearby materials on fire. Keep the area around the appliance free from combustibles.

### **WARNING**

**DO NOT** supply the appliance with a gas that is not indicated on the data plate. If you need to convert the appliance to another type of fuel, contact your dealer.

### **WARNING**

If gas flow to appliance is interrupted, or pilots extinguish, wait 5 minutes before attempting to relight the pilot to allow any residual gas in appliance to dissipate.

### **WARNING**

Ensure that the appliance can get enough air to keep the flame burning correctly. If the flame is starved for air, it can give off a dangerous carbon monoxide gas. Carbon monoxide is a clear odorless gas that can cause suffocation.

### **WARNING**

Never add oil to the appliance when it is at operating temperature. Splashing hot oil can cause severe injuries.

### **WARNING**

Never add water to hot oil. Violent boiling can occur causing severe injury.

### **WARNING**

This appliance is intended for professional use only and should be operated by fully trained and qualified personnel.

### **WARNING**

To avoid splashing of hot liquid when installed, this fryer must be restrained either in the manner of installation, or with adequate ties to prevent tipping.

### **WARNING**

In North America, gas appliances equipped with casters must be installed with connectors that comply with the Standard for Connectors for Movable Gas Appliances, ANSI Z21.69.CSA 6.16 Latest Edition. This connection should include a quick disconnect device that complies with the Standard for Quick Disconnect Devices for Use with Gas Fuel ANSI Z21.41.CSA 6.9 Latest Edition. In Australia, an appliance equipped with casters and a flexible gas line must be connected to the gas supply with a quick disconnect device that complies with AS 4627 and a restraining cable. The restraining cable must not exceed 80% of the length of the flexible gas line.

### **WARNING**

This appliance is not intended for used by a person (including children) with reduced physical, sensory or mental capabilities, or lack of experience and knowledge, unless they have been given supervision or instruction concerning use of the appliance by a person responsible for their safety. Children should be supervised to ensure that they do not play with the appliance.

### **WARNING**

Children should not be in the vicinity of this appliance when it is being operated, cleaned, maintained or serviced nor allowed to play on and/or with the appliance at any time.

# INSTALLATION & OPERATIONAL MANUAL

<b>1. THEORY OF OPERATION</b>	<b>7</b>
<b>2. INSTALLATION</b>	<b>8</b>
2.1. CHECKING AND UNPACKING YOUR NEW APPLIANCE	8
2.2. INSTALLATION CLEARANCES	9
2.3. LEVELING THE FRYER – LEGS/CASTERS	10
2.4. GAS CONNECTION	11
2.5. QUICK DISCONNECT CONNECTION	12
2.6. FUEL SUPPLY LINE LEAK AND PRESSURE TESTING	12
2.7. INSTALLATION SETUP	12
2.8. ELECTRICAL CONNECTIONS	13
2.9. VENTILATION AND FIRE SAFETY SYSTEMS	14
2.10. INSPECTION	15
2.11. INITIAL ADJUSTMENTS	15
2.11.1. FILLING THE APPLIANCE	15
2.11.2. LIGHTING INSTRUCTIONS	16
2.11.3. PILOT FLAME ADJUSTMENT	16
2.11.4. MAIN BURNER SYSTEM ADJUSTMENT	17
2.12. INITIAL CLEANING	18
<b>3. OPERATION</b>	<b>19</b>
3.1. OPERATIONAL FEATURES	19
3.2. BASIC OPERATIONAL FEATURES	20
3.3. FILLING THE FRYPOT	21
3.4. FILLING THE TANK WITH OIL/LIQUID SHORTENING	21
<b>4. APPLIANCE START UP</b>	<b>22</b>
4.1. COOKING	23
4.2. COOKING TIPS	23
4.3. BASKET LIFT OPERATION	23
<b>5. FRESH OIL TOP OFF FUNCTION</b>	<b>23</b>
<b>6. AUTOMATIC OIL TOP OFF SYSTEM (OPTION)</b>	<b>23</b>
<b>7. QUICK STRAIN FILTERING</b>	<b>24</b>
7.1. NON-AUTO FILTER MODELS	24
7.2. AUTO FILTER MODELS	24
<b>8. APPLIANCE SHUTDOWN</b>	<b>25</b>
8.1. STANDBY MODE	25
8.2. COMPLETE SHUTDOWN	25
<b>9. PREVENTATIVE MAINTENANCE</b>	<b>25</b>
9.1. DAILY PREVENTATIVE MAINTENANCE	25
9.1.1. DAILY CLEANING	25
9.1.2. REPLACING THE FILTER MEDIA	26
9.1.3. APPLIANCE INSPECTION	27
9.1.4. CLEANING THE FRYPOT	27
9.1.5. CLEANING THE CABINET	27
9.1.6. FILTER CLEANING	27
9.2. WEEKLY PREVENTATIVE MAINTENANCE	28
9.3. MONTHLY PREVENTATIVE MAINTENANCE	28

## INSTALLATION & OPERATIONAL MANUAL

9.3.1.	BOIL OUT PROCEDURE.....	28
9.3.2.	TEMPERATURE CHECK.....	29
9.4.	ANNUAL/PERIODIC PREVENTATIVE MAINTENANCE AND INSPECTION.....	30
9.4.1.	SAFETY EVALUATION.....	30
9.4.2.	MECHANICAL INSPECTION.....	30
9.4.3.	TEMPERATURE CONTROL SYSTEM.....	30
9.4.4.	FILTER SYSTEM.....	30
9.4.5.	GAS COMBUSTION SYSTEM.....	31
9.4.6.	CONTROL BOX & ELECTRICAL COMPONENTS.....	31
9.5.	VENTILATION HOOD.....	31
<b>10.</b>	<b>TROUBLESHOOTING.....</b>	<b>32</b>
10.1.	POWER FAILURE.....	32
10.2.	HIGH TEMPERATURE LIMIT SWITCH.....	32
10.3.	DRAIN VALVE INTERLOCK.....	32
10.4.	SELF CLEANING BURNER SYSTEM.....	33
10.5.	RESETTING THE SELF CLEANING BURNER ROLL OUT SWITCH.....	33
10.6.	TROUBLESHOOTING CHARTS.....	34
10.6.1	FRYER TROUBLESHOOTING CHART.....	34
10.6.2	FRYER TROUBLESHOOTING CHART (if equipped).....	34
10.6.3	COMPUTER CONTROLLER DISPLAYS.....	35

## 1. THEORY OF OPERATION

The Pitco Reduced Oil Volume fryer works very similarly to the standard Pitco SG/SSH fryer.

The Reduced Oil Volume Fryer has a smaller cold zone to significantly reduce oil usage and extend oil life. This smaller zone may require more frequent filtering depending on the product being fried.

Upon turning the fryer on, the high limit closes the (side on) safety relay which stays closed until the fryer is turned off. If the oil temperature exceeds 450 degrees F, the high limit opens and prevents further operation until the cooking oil has reached a safe cooking temperature. This places a minimum duty cycle on the safety (side on) relay to insure its proper operation when needed. The “heat demand” relay opens and closes on demand from the primary control to maintain the desired cooking temperature. When the “heat demand” relay closes, it energizes the main burners in the frypot. Near the fryer pot heat tubes, the temperature probe and high limit can be found. The temperature probe provides a signal to the primary control, sensing the oil temperature in the frypot.

The fryer is equipped with a manual “ADD OIL” function that can transfer fresh oil from a JIB (Jug in Box) located under the fryer or a bulk oil management system. The operator can use this function as needed to replenish any oil consumed in the cooking process. It is recommended that oil only be added when the frypot is at the desired temperature, and that the “ADD OIL” button not be used to fill an empty frypot from the JIB.

Optional Automatic Top Off: If equipped, the fryer (only when operating at desired temperature) senses the oil level and replenishes consumed oil only if the display shows ready. There are no programming options for the operator or service technician, the control functions like any other Pitco computer control. The “ADD OIL” button (described above) is present with Auto Top Off.

## 2. INSTALLATION

### 2.1. CHECKING AND UNPACKING YOUR NEW APPLIANCE

Your new Pitco appliance has been carefully packed into one crate. Every effort has been made to ensure that it is delivered to you in perfect condition. Pitco does not assume responsibility for damage or loss incurred in transit.

1. Upon Delivery, inspect for visible shipping damage in the presence of the trucking operator. If something appears damaged, file a claim for damages regardless of extent.
2. Unpack and inspect unit for damage. Contact the shipper within 15 days and file a concealed damage claim; the shipper is only responsible for concealed damage for 15 days after delivery.
3. Remove the unit from the shipping pallet:
  - a: Remove the filter pan, and JIB pan from unit before attempting to dismount the unit from the shipping base.
4. Do not allow the full weight of the unit to rest on the legs or caster when removing the appliance from the shipping pallet. The casters can be bent or damaged if too much weight or force is applied to them from improper handling.
5. Check the packing list enclosed with your appliance to ensure that you have received all the parts to the appliance. If you are missing any parts, contact the dealer from whom the appliance was purchased.
6. Using the front cover of this manual, record the following for warranty service or future reference:
  1. Your Pitco model number.
  2. Fryer serial numbers (Found on the inner door of each fryer).
  3. The date purchased from your dealer invoice.

Once you have completed the above, the appliance is ready to be installed. Although it may be possible for you to install and set up your new appliance, it is **STRONGLY** recommended that you have this done by qualified professionals. A qualified professional will ensure that the installation is safe and meets local building and fire codes.

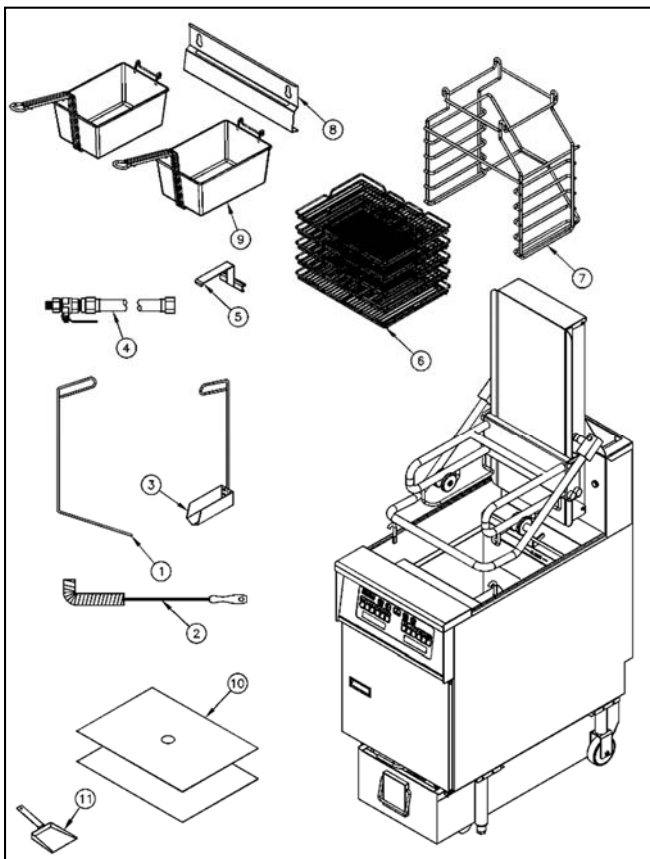

**Accessories**

#	Description	
1	Frypot drain clean out rod	Standard
2	Frypot cleaning brush	Standard
3	Frypot crumb scoop	Standard
4	Flexible gas hose with disconnect	Optional
5	Rack handle	Standard with Lift Assist
6	Product racks	Standard with Lift Assist
7	Rack holder	Standard with Lift Assist
8	Basket hanger	Optional in lieu of Lift Assist
9	Fry baskets	Optional in lieu of Lift Assist
10	Filter paper	Standard
11	Filter shovel scoop	Standard



**2.2. INSTALLATION CLEARANCES**

The clearances shown below are for combustible and non-combustible installations and will allow for safe and proper operation of your appliance.

	<b>Combustible Construction</b>	<b>Non-Combustible Construction</b>
	Inches (centimeters)	Inches (centimeters)
<b>Back</b>	6.0" (15.2cm)	0.0" (0.0cm)
<b>Sides</b>	6.0" (15.2cm)	0.0" (0.0cm)
<b>Floor</b>	9" (22.86 cm)	9" (22.86 cm)

In addition to the above clearances there must also be at least 30 inches (76.2cm) of aisle space in front of the appliance.

<b>WARNING</b>
<b>Leave at least 18 inches (47cm) of open space between the flue of the appliance and the intake of the exhaust hood. Failure to do so could result in improper operation of the appliance.</b>
<b>WARNING</b>
<b>DO NOT obstruct the flow of ventilation, or air openings around the appliance. Adequate clearance around the appliance is necessary for servicing and proper component ventilation. Ensure that you meet the minimum clearance requirements specified in this manual.</b>
<b>WARNING</b>
<b>DO NOT install this appliance next to a water cooker, or use it in any way in which water can come in contact with the hot oil. Splash over of water into hot oil may result in a steam eruption, potentially causing hot oil to be ejected from the fryer, and creating a burn hazard.</b>

**2.3. LEVELING THE FRYER – LEGS/CASTERS**

<b>CAUTION</b>
To prevent equipment damage and/or personal injury, do not tilt the appliance onto any two of its casters or legs, or pull the appliance by the splash back.
<b>WARNING</b>
This appliance <u>must</u> be installed with the legs or casters provided by the manufacturer.
<b>WARNING</b>
<b>DO NOT</b> perform leveling procedure when appliance is in operation or full of hot liquids. Serious injury could result.

When you receive your appliance, it is completely assembled with legs or optional casters. This appliance must be installed with legs or casters; it cannot be curb mounted, or sealed to a base. Curb mounting will seriously inhibit this appliance’s ability to effect proper component ventilation. The supplied legs or casters provide the necessary height to meet sanitation requirements and assure adequate air supply for electrical component ventilation. To level the fryer, use the following procedure.

Required tools: Large pair of water pump pliers, Medium flat blade screwdriver, level 12” (30.5 cm) long max.

- 1 Position appliance in final installed location.
- 2 Apply level across front, and then the left and right side of unit, determine lowest point, and distance to level.
- 3 Add the distance determined in step 2 to caster or leg on the lowest corner of appliance.
  - a. Swivel casters- loosen 2 set screws (A)
  - b. Legs and swivel casters-. Adjust the height of the leg / caster by turning adjustment collar/ foot (B) with water pump pliers until desired change in height is achieved.  
Swivel casters only: Retighten set screws (A).
  - c. Fixed casters- Adjust height by moving wheel and axle to alternate holes (D) in wheel bracket higher or lower as needed. Refer to “FIXED” type caster in Figure 3.
- 4 Adjust remaining casters or legs as needed to insure the appliance is supported evenly at each caster/leg contact point.

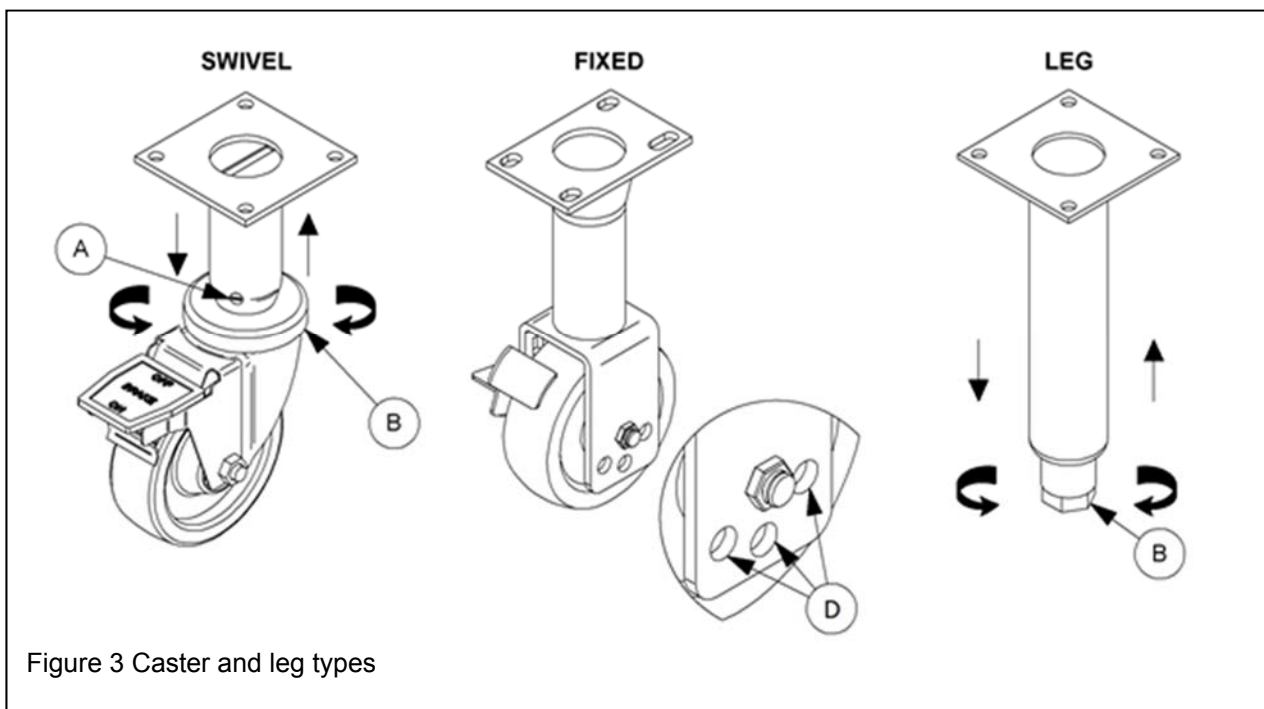

**2.4. GAS CONNECTION**

Your gas appliance will give you peak performance when the gas supply line is of sufficient size to provide the correct gas pressure. The gas line must be installed to meet the local building codes or National Fuel Gas Code ANSI Z223.1 Latest Edition. In Canada, install the appliance in accordance with CAN/CGA-B149.1 or .2 and local codes. In Australia, install the appliance in accordance with AS/NZS 5601. Gas line sizing requirements can be determined by your local gas company or, in North America, by referring to the National Fuel Gas Code, Appendix C, Table C-4 (for natural gas) and Table C-16 (for propane). The gas line needs to be large enough to supply the necessary amount of fuel to all appliances without losing pressure to any appliance.

A properly sized and installed gas line will deliver a supply pressure between 7.0" W.C. (17.4mbars, 1.74kPa) and 10.0" W.C. (24.9mbars, 2.49kPa) natural gas or between 11.0" W.C. (27.4mbars, 2.74kPa) and 13.0" W.C. (32.5mbars, 3.25kPa) for propane to all appliances connected to the supply line, operating simultaneously at full demand. The pressure at the gas valve shall not exceed ½ PSI (13.85 "WC, 34.5 mbar, 3.45 kPa). The gas supply connection to this appliance is located in the rear of the appliance approximately 10-1/2" (26.7 cm) from the floor of the appliance when legs are used.

Each appliance is equipped to operate on one certain fuel type. The type of fuel with which the appliance is intended to operate is stamped on the data plate, which is attached to the inside of the door.

**WARNING**

**NEVER supply the appliance with a gas other than the one that is indicated on the data plate. Using the incorrect gas type will cause improper operation and could result in serious injury or death. If you need to convert the appliance to another type of fuel, contact the dealer you purchased it from.**

EU GASTECHNICAL INFORMATION														
Applicable Countries	Model	Fuel Type	Gas	Appliance Category	Gross Input (kW)	Net Input (kW)	Supply Pressure (mbar)	Burner Pressure (mabr)	Burner Orifice	Pilot Orifice (code)	Governor	Normal Gas Rate (m3/hr)		
AT, BG, CH, CZ, DK, EE, FI, GB, GR, HU, IE, IT, LT, LV, NO, PL, PT, RO, ES, SI, SK, SE, TR	SGLVRF	Nat	G20	I <sub>2H</sub>	36.6	33	20	10	#43	N22	YES	3.5		
				I <sub>2E</sub>							#43 / #40	NO	3.5/4.1	
				I <sub>2ESI</sub>								YES		
				G20/G25								I <sub>2E+</sub>		YES
				G20/G25								I <sub>2ELL</sub>		YES
				G25/G25.3								I <sub>2L</sub> -I <sub>2EK</sub>		YES
				I <sub>3P</sub>								YES		
BG, CH, CY, CZ, FR, DE, GB, GR, HU, IE, IT, LU, MT, NL, PL, PT, RO, ES, SI, SK, TR	LP	G31	I <sub>3P</sub>			37/50	25.4	1.45 mm	LP16	YES	1.4			

US and Canada				
Model	Gas Type	Orifice Tip Size	Burner Pressure (In. W. C.)	Gross Input (Btu/hr)
SGLVRF	NAT	#43	4	125,000
	LP	1.45 mm	10	125,000

Australia				
Model	Gas Type	Orifice Tip Size	Burner Pressure (kPa)	Gross Input (Mj/hr)
SGLVRF	NAT	NOT APPROVED FOR USE IN THIS COUNTRY		
	LP			

**Netherlands Only - Natural Gas**

This unit has been set for the appliance category K (I2K) and is suitable for the use of G and G+ gas distribution according to the specifications as shown in the NTA 8837: 2012 Annex D with a Wobbe index from 43.46 to 45.3 MJ/m<sup>3</sup> (dry, 0°C, above value) or from 41.23 to 42.98 (dry, 15°C, upper value). This unit can also be converted and / or adjusted again for the appliance category E (I2E) This therefore means that the device "is suitable for G+ gas and H-gas, it is demonstrably suited for G+ gas and demonstrable is suitable for H-gas "within the meaning of the "Decision of May 10, 2016 amending the Decree on gas appliances ...."

**NOTICE**

**NEVER use an adapter to make a smaller gas supply line fit the appliance connection. This may not allow proper gas flow for optimum burner operation, resulting in poor performance and improper operation.**

**2.5. QUICK DISCONNECT CONNECTION**

In North America, gas appliances equipped with casters must be installed with connectors that comply with the Standard for Connectors for Movable Gas Appliances, ANSI Z21.69.CSA 6.16 Latest Edition. This connection should include a quick disconnect device that complies with the Standard for Quick Disconnect Devices for Use With Gas Fuel Appliances ANSI Z21.41.CSA 6.9 Latest Edition. In Australia, an appliance equipped with casters and a flexible gas line must be connected to the gas supply with a quick disconnect device that complies with AS 4627 and a restraining cable. The restraining cable must not exceed 80% of the length of the flexible gas line. The restraining device should be attached to the appliance at the back panel.

**2.6. FUEL SUPPLY LINE LEAK AND PRESSURE TESTING**

The fuel supply system must be tested before the appliance is used. If the fuel line is going to be tested at a pressure greater than ½ PSIG (3.45 kPa, 34.5 mbar), insure that that appliance is disconnected from the fuel line. If the fuel line is to be tested at a pressure equal to or less than ½ PSIG (3.45 kPa, 34.5 mbar), the appliance can be connected during the test, but the unit's gas valve must be shut. Test all gas line connections for leaks with a solution of soap and water when pressure applied.

**2.7. INSTALLATION SETUP**

The installation of this appliance *MUST* conform to local codes. In the absence of local codes in North America, the installation must conform with the National Fuel Gas Code, ANSI Z223.1/NFPA 54 or the Natural Gas and Propane Installation Code CSA B149.1 as applicable. In Australia, the appliance must be installed in compliance with AS/NZS 5601 (current revision)

**2.8. ELECTRICAL CONNECTIONS**

It is advised that this power supply be plugged into a wall receptacle that is controlled by the ventilation control. This will prevent the appliance from being operated without the ventilator on. If your appliance requires an electrical connection, the power requirements are listed below.

A full version of the wiring diagram can be found adhered to the inner door(s) of the appliance.

	North America	International
Input Voltage	120 VAC, 50/60 Hz	220, 230 or 240 VAC 50/60 Hz
Current per unit	1.0 Amp	0.5 Amps
Filter Current	7.5 Amp	4.2 Amps

<b>CAUTION</b>
<b>Connecting the appliance to the wrong power supply may damage the appliance and void the warranty.</b>
<b>WARNING</b>
<b>This appliance must be connected to a power supply having the same voltage and phase as specified on the data plate located on the inside of the appliance door.</b>
<b>WARNING</b>
<b>DO NOT attempt to connect the appliance to an electrical supply other than that indicated on the data plate. Electrical connection should be performed by qualified personnel.</b>
<b>WARNING</b>
<b>The electrical connection used by this appliance must comply with local codes. In the United States if there are no local codes that apply, refer to the National Electrical Code (NEC), ANSI/NFPA 70 for installation in the US. In Canada, refer to CSA Standard C22.2 and local codes. In all other cases, refer to local and national codes and regulations.</b>
<b>WARNING</b>
<b>Your appliance is equipped with an oil proof, electrical supply cord with a three-prong safety plug. This is to protect operators from electrical shock hazard in the event of an equipment malfunction. DO NOT cut or remove the grounding (third) prong from this plug. The appliance should be plugged into a properly grounded three-prong receptacle.</b>

### 2.9. VENTILATION AND FIRE SAFETY SYSTEMS

Your new appliance must have proper ventilation to function safely and properly. Exhaust gas temperatures can reach as high as 1100 °F (593 °C). Therefore, it is very important to install a fire safety system. Your ventilation system should be designed to allow for easy cleaning. Frequent cleaning and proper maintenance of the ventilation system and the appliance will reduce the chances of fire. Ventilation and fire safety systems must comply to local and national codes for US and Canada. Refer to ANSI 83.11 for a list of reference documents that will provide guidance on ventilation and fire safety systems. For installations in U.S. and Canada, additional information can be obtained from CSA International, 8501 East Pleasant Valley Road, Cleveland, OH, 44131 or visit their website at [www.csa-international.org](http://www.csa-international.org). In Australia, the ventilation system must comply with AS/NZS 5601.0.

It is essential that the appliance be operated only when adequate ventilation is provided. Your ventilation hood should be properly maintained. A qualified installation professional should ensure that the hood is operating properly in conjunction with the appliance. Inadequate ventilation may not properly evacuate all appliance emissions. Excessive or unbalanced ventilation may cause drafts, which could interfere with proper operation of the pilot and burners. Leave at least 18 inches (47cm) of open space between the flue of the appliance and the intake of the exhaust hood.

#### **WARNING**

**Ensure that your ventilation system does not cause a down draft at the appliance's flue opening. A down draft will not allow the appliance to exhaust properly and will cause overheating, which may cause permanent damage. Damage caused by down drafts will not be covered by the warranty. NEVER allow anything to obstruct the flow of combustibles or ventilation exiting the appliance. NEVER place anything on top of the flue area, or block the flue in any way. Never place a grease condensing drip pan over the flue opening.**

#### **WARNING**

**NEVER connect the ventilation blower or hood directly to the flue of this appliance. The resulting increased flow of air through the combustion system will cause improper operation, poor temperature recovery, poor ignition and could extinguish the pilot.**

#### **WARNING**

**Replacing or adding appliances under a pre-existing fire safety system may require modifications to the system. ALWAYS contact a professional who is qualified in installing, designing and maintaining your fire safety system to assure that any appliances located under the fire safety system are adequately protected.**

For Australia, the fryer must be installed in accordance with AS/NZS 5601, local authority and any other relevant statutory regulations. Flexible hose (if used) must comply with AS/NZS 1869 Class B or D, be of appropriate internal diameter, be kept as short as possible (not exceed 1.2 meters), must not be kinked and not be in contact with a hot surface. A chain must be fitted to restrict the fryer movement to no more than 80% of the hose length.

## 2.10. INSPECTION

Before you begin filling and adjusting the appliance, perform the following visual checks:

- ✓ After the appliance is in its permanent location, check the levelness. Any additional leveling that is necessary can be performed as previously described.
- ✓ Ensure that the sensing probe and high temperature limit bulb are in place and secure. Check the high limit bulb mounting screws to ensure that they are tight.
- ✓ Review the installation portion of this manual and ensure that all steps have been followed and executed properly.

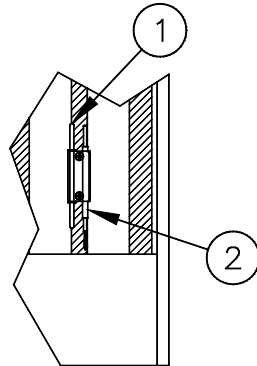

- 1) Probe
- 2) High Temperature Limit

## 2.11. INITIAL ADJUSTMENTS

After your appliance has been properly installed as described in the installation section of this manual, it will need to be adjusted to ensure that it will perform as designed. A qualified person must perform these adjustments.

**To perform these adjustments the following tools will be needed:**

- Manometer
- Digital Thermometer (Temperature Probe)
- DC Microammeter
- DC Voltmeter

### 2.11.1. FILLING THE APPLIANCE

Refer to the following procedure to fill the frypot prior to operation.

1. Ensure that the drain valve is closed.
2. Fill the tank to about ½" (1.25 cm) below the oil level line with oil/liquid shortening. The oil/liquid shortening level will rise slightly as it heats up. Never let the oil/liquid shortening level go below the MIN LEVEL mark stamped on the tank.

#### WARNING

**Oil/liquid shortening must completely cover the heat tubes at all times while appliance is on.**

#### CAUTION

**This appliance is not designed for cooking with water. Fill with oil or liquid shortening only.**

#### WARNING

**During operation, there is an open flame inside this appliance. The unit may get hot enough to set nearby materials on fire. Keep the area around the appliance free from combustibles.**

**2.11.2. LIGHTING INSTRUCTIONS**

There is nothing to manually light on the SGLVRF. Pilot ignition is performed and controlled by the electronic ignition system. Refer to the following instructions to light the appliance.

1. Verify that all electrical connections, clearances, gas connections, ventilation requirements and gas pressures have been properly implemented, tested, adjusted and checked for compliance in accordance with the instructions and requirements in Section 2 of this document prior to proceeding.
2. Open the gas supply valves to the appliance.
3. Turn the gas valve knob to the ON position.
4. Turn the controller on. Press the  button to turn the COMPUTER on.
5. The main burners will light and be controlled by the computer.

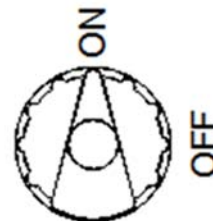

**Note: If your appliance has a self cleaning burner system, the burners may make a popping sound immediately after the main burners light during startup. This noise during startup is part of the normal operation of the self cleaning burner system and should NOT continue during normal cooking & idle periods. (SCB Only)**

**WARNING**

**Do not store flammable materials in or near this appliance. Do not spray aerosols in the vicinity of this appliance while it is in operation.**

**WARNING**

**Contact a qualified service person or the factory, using the information on the back of this manual if the appliance produces unusual odor, yellow tipping flames or is otherwise not functioning properly.**

**2.11.3. PILOT FLAME ADJUSTMENT**

Perform this procedure with the pilot lit.

**Note: This procedure requires the use of a DC microammeter.**

1. Connect the DC microammeter between the flame sensor terminal and the flame sensor lead. Observe proper polarity: if the meter needle goes below 0, reverse the leads. The current reading must be or 0.15  $\mu$ A or greater.
2. Adjust the current reading to the required level by adjusting the pilot flame. Remove the pilot adjustment screw cap to expose the pilot adjustment screw. Turning the pilot adjustment screw clockwise will decrease the size of the pilot flame and flame sense current. Turning the pilot adjustment screw counterclockwise will increase the pilot flame size and the flame sense current.
3. Rotate the screw in the direction needed to achieve a reading of 0.15  $\mu$ A or greater.

Note: Allow 3 to 5 minutes between flame adjustments to allow the reading to stabilize.

4. Once the pilot flame has been adjusted properly, replace the pilot adjustment screw cap screw and remove the microammeter.

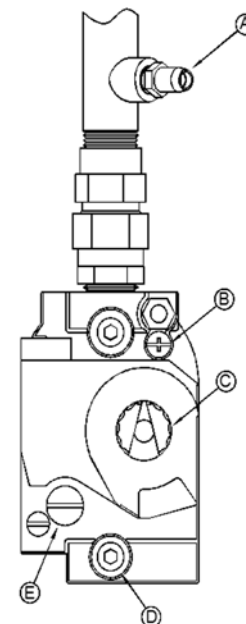

A Burner Pressure Tap  
 B Pilot Adjustment Screw Cap  
 C ON/OFF Knob  
 D Inlet Pressure Tap  
 E Burner Pressure Adjustment Screw Cap



#### 2.11.4. MAIN BURNER SYSTEM ADJUSTMENT

For the main burners to operate the gas supply valve must be open and the main power button on the computer must be pressed. The main burners receive gas from the main gas supply through the thermostatically controlled valve. When the oil temperature drops below the preset temperature the gas control valve opens.

The main burners must be adjusted to deliver optimum flame. Refer to the following procedure to adjust the main burners.

1. Ensure that the main gas valve is shut off, remove the burner pressure tap plug and connect an accurate pressure gauge (range of 0-16 "W.C. (39.85mbar, 3.98kPa) in 0.1" (.25mbar, .02kPa) increments) or manometer.
2. Turn on this and all appliances connected to the gas supply line and light their main burners. The pressure reading of the installed pressure gauge should not drop from the required installation pressure. Any loss of pressure indicates inadequate supply line installation, which will cause poor performance of all appliances during peak usage.
3. The installed pressure gauge should be the same,  $\pm 0.1$ " W.C. (.25mbar, .02kPa), as that marked on the data plate on the inside door of the appliance. If the pressure is correct, go to step 6, if it is not, adjust the pressure as outlined in step 4.
4. To adjust the pressure, remove the burner pressure adjustment screw cap and, with a flat head screwdriver, adjust the regulator screw until the proper burner pressure is reached. Turning the screw clockwise will increase the burner pressure. Turning the screw counterclockwise will decrease the burner pressure. When the pressure is correct, replace the regulator adjustment screw cover.
5. Turn off ALL appliances, shut the main gas valve to your Pitco appliance and remove the pressure gauge. Apply pipe joint compound to the manifold pressure tap plug and reinstall it.
6. Check for leaks at the pressure tap fitting.

#### CAUTION

**Be careful not to disturb the probe and high temperature limit bulb and capillary during operation or cleaning of this appliance.**

**2.12. INITIAL CLEANING**

When your appliance is shipped, many of its parts are covered with a thin coat of oil for protection. Before the appliance is ready for cooking all transit material must be removed and the appliance must be cleaned. This will remove the oil coating and any foreign matter that may have accumulated during storage and shipment. Refer to the following procedure to clean the appliance.

**WARNING**

**Wear protective gloves and clothing when cleaning and draining the appliance and when disposing of water. The water is extremely hot and can cause severe injuries.**

**CAUTION**

**DO NOT leave the appliance unattended during cleaning. Never let the liquid level go below the heat tubes.**

**NOTICE**

**DO NOT run water through the filter return system. This will damage the pump and void your warranty.**

**WARNING**

**NEVER attempt to move the appliance when it is filled with HOT liquids or at operating temperatures. Severe burns could occur.**

1. Read "Section 3 OPERATION" of this manual prior to filling or operating the appliance.
2. The following steps should be followed using a food grade cleaner.

**WARNING**

**Use a commercial grade cleaner formulated to effectively clean and sanitize food contact surfaces. Read the directions and precautionary statements before use. Particular attention must be paid to the concentration of cleaner and the length of time the cleaner remains on the food contact surfaces.**

3. Follow the cleaning directions in this manual to clean the tank interior and all other food contact surfaces. (9.3.1 Boil Out Procedure, page 28)
4. When cleaning is complete, rinse the inside of the tank thoroughly with cool water. Continue to rinse the tank until the cleaner has been completely and thoroughly rinsed from the tank.
5. Using a clean dry cloth, wipe out all of the water in the fry tank.
6. Using a clean cloth and food grade cleaner, clean the bread and batter station and/or filter pan, if equipped.

If the appliance can't be adjusted to operate properly contact a qualified service person or contact the factory using the contact information on the back of this manual.

### 3. OPERATION

An operator's manual for your appliance's specific control type should be included with this manual. Refer to that manual prior to operating this appliance.

**WARNING**

**Before operating the fryer, check that tipping restraints or other features to prevent tipping are installed and mechanically sound. Splashing of hot liquid may occur if adequate means of securing the fryer in place are not used.**

#### 3.1. OPERATIONAL FEATURES

The diagram below outlines some of the key operational components of your appliance. Refer to the following sections of this manual to learn more about these features.

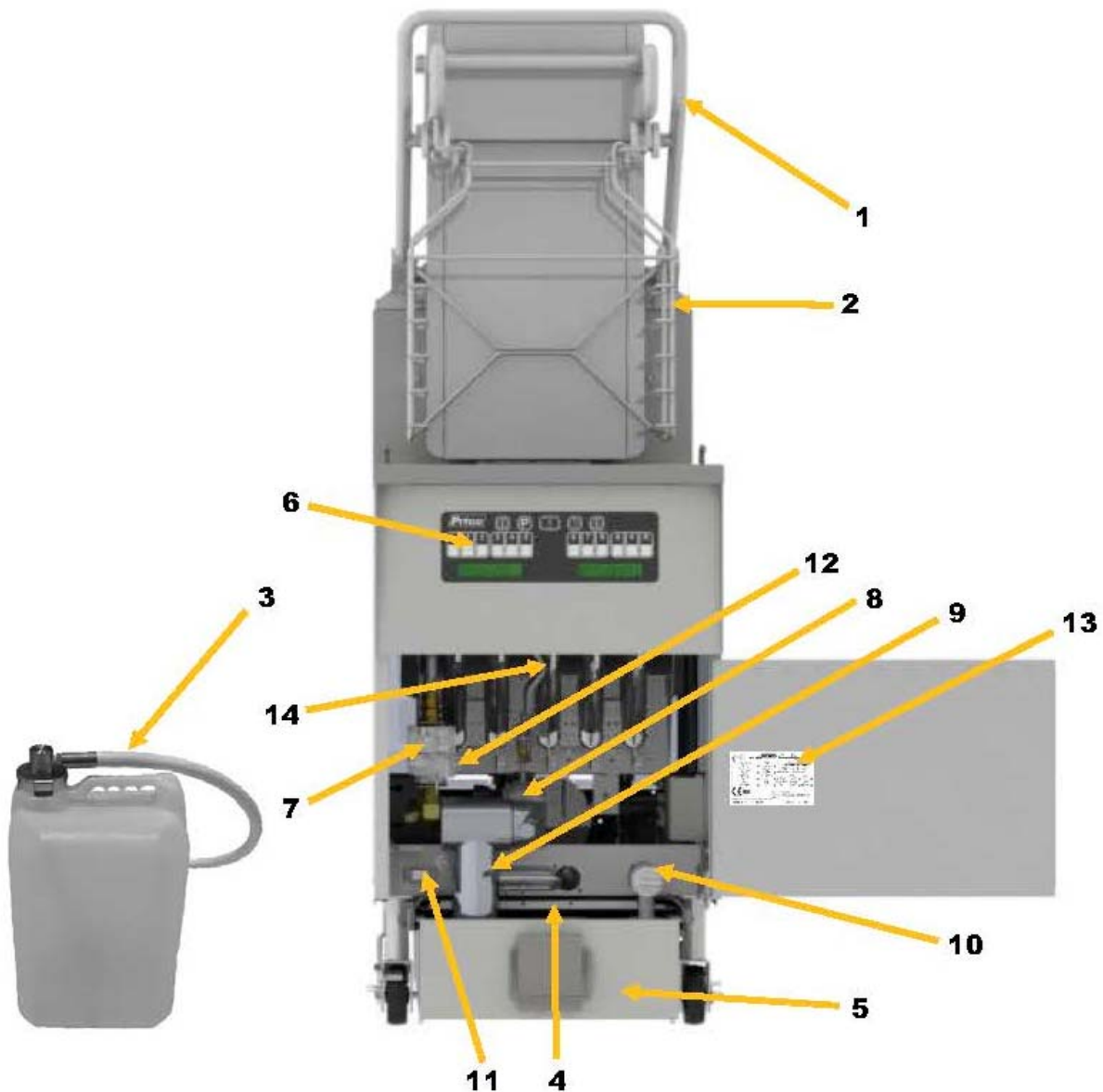

**3.2. Basic operational Features**

1. **Rack Lift Assist** – Spring assisted lift for easy in moving racks in and out of the frypot.
2. **Rack Holder** – Holds five wire racks of product.
3. **Frypot oil top off supply jug**- Supplied by others, provides storage for fresh cooking oil.
4. **Filter Pan Cover** – Prevents debris from falling into filter pan when in use. Easily slides out for cleaning.
5. **Filter Pan Assembly** - Holds oil during frypot cleaning and filtering. Contains filter pick up assembly, and pick up tube
6. **Controller** - Controls frypot temperature, provides cook time tracking and other functions.
7. **Gas Valve Control Knob**- Turns gas valve ON or OFF.
8. **Filter Motor Thermal Overload Reset button (RED)** - Press to reset. SEE WARNING BELOW
9. **Drain Outlet** – Swings out to ease shortening disposal. **CAUTION: Extremely HOT when in use.**
10. **Pump Strainer** – Helps prevent debris from jamming filter pump if filter paper rips or is installed poorly.
11. **Filter Pump Circuit Breaker**- Protects pump motor from over current. SEE WARNING BELOW
12. **Frypot High Limit Reset Button** - (Shown in Section 10.2 on page 32) - Press to reset.
13. **Data Plate Label** – Displays operational specifications and other important information.
14. **SCBS Roll Out Switch Reset Button** – (Shown in Section 10.5, on page 33) Press to reset.

**WARNING**

Resetting either the filter pump circuit breaker or the filter pump motor thermal overload may cause unexpected hot oil discharge if a refill switch or flush hose valve (if equipped) is left in the ON position. Always verify the appliance is turned OFF and that the filter return switches, or the flush hose valves (if equipped) are OFF and safely positioned before resetting the breaker or thermal overload.

**WARNING**

Opening the drain valve will lead to the outflow of the hot contents of the deep fat fryer.

**NOTICE**

These appliances are intended to be used for commercial applications, for example in the kitchens of restaurants, canteens, hospitals and in commercial enterprises such as bakeries, butcheries, etc., but not for continuous mass production of food.

**3.3. FILLING THE FRYPOT**

Only use oil or shortening that is liquid at room temperature in this appliance.

**CAUTION**

**This appliance is NOT designed for cooking with water. Cook with oil or liquid shortening only.**

**WARNING**

**This appliance is NOT designed for use with solid shortening. Using solid shortening will cause the filter pump and oil lines to become plugged, and require professional service personnel to fix and will not be covered under the warranty.**

**WARNING**

**NEVER attempt to move the appliance when it is filled with HOT liquids or at operating temperatures. Severe burns could occur.**

**3.4. FILLING THE TANK WITH OIL/LIQUID SHORTENING**

To fill the tank with oil/liquid shortening, refer to the following procedure.

Tank Capacity

MODEL	CAPACITY
SGLVRF	73 lbs. (33.1 kg)

It is recommended that high quality liquid frying oils be used for longest oil life.

1. Verify that the tank interior is clean and free of any construction debris.
2. Rinse the tank and drain line with a small amount of clean cooking oil.
3. Ensure that the drain valve is closed.
4. Fill the tank to about the oil level mark. The oil will expand when heated up, raising the level to OIL LEVEL line.
5. After the cooking oil is at operating temperature, add oil to the frypots using the Top Off button as needed to obtain the desired operating level.

**WARNING**

**THE PUSH BUTTON TOP OFF SYSTEM IS NOT INTENDED TO FILL FRYPOTS.**

**WARNING**

**Replace oil/liquid shortening that is smoking, or foams when cooking. Old, heavily used oil/liquid shortenings have reduced flash point, and are prone to surge boiling. Cooking with old, heavily used oil/liquid shortening may create dangerous conditions.**

**WARNING**

**Do not overload the fry baskets, or allow the oil level to exceed the MAX line while cooking. Wet product, or too much oil in the frypot can lead to surge boiling, and over topping the frypot. Overtopping may create hazards such as burns or slippery floors.**

**CAUTION**

**This appliance is NOT designed for cooking with water. Severe equipment damage will occur if a fryer is used as a water bath for rethermalizing foods. Damage of this type is not covered under the warranty.**

**WARNING**

**Oil/liquid shortening must completely cover the heating tubes at all times while appliance is ON.**

## 4. APPLIANCE START UP

If the appliance is plugged in and has power the display will show **OFF**. Refer to the following procedure to start the appliance prior to operation.

1. On manual (non-Auto Filter) models verify that the drain valve is closed by ensuring that the blue drain handle is pushed all the way in. **Failure to do so may result in unsafe conditions.**
2. Fill the frypot with oil/liquid shortening. (See section 3.3 “Filling the Frypot”). Never operate the appliance unless the frypot is properly filled.
3. Press the  button to turn the controller on. Manual models will begin proper operation. Auto-Filter models will display the prompt ‘Is vat full?’. Press the ‘YES’ key if the tank is full otherwise press the ‘NO’ key. **Failure to accurately respond to this prompt may result in unsafe conditions.**

**Note: If your appliance has a self cleaning burner system, the burners may make a popping sound immediately after the main burners light during startup. This noise during startup is part of the normal operation of the self cleaning burner system and should NOT continue during normal cooking & idle periods.**

4. The appliance is now on and heating the oil/liquid shortening in the frypot.

### WARNING

**NEVER operate the appliance with an empty fry tank. It will void the warranty.**

### WARNING

**The oil/liquid shortening level should NOT be allowed to fall below the indicated level line at any time. Dry firing of the fry tank may cause a fire and will shorten the tank’s service life. Evidence of dry firing will void your warranty.**

### OIL TEMPERATURE

Keep the oil temperature in the fryer to a maximum of 190°C (374°F). Higher temperatures will cause rapid breakdown of the oil and give you no faster cooking. At 205°C (401°F) to 210°C (410°F) the life of the oil is only one third of its life at 190°C (374°F). In addition, increased decomposition causes the oil to smoke badly even if the temperature is lowered to 190°C (374°F) again. High temperatures give you no advantage, cost you money and increase the fire danger.

### TEMPERATURE DELL’OLIO

Mantenere la temperatura dell’olio nella friggitrice fino a un massimo di 190°C. Temperature maggiori causano un rapido degrado dell’olio, senza tuttavia eseguire una cottura più rapida. Da 205°C a 210°C la durata dell’olio è inferiore di un terzo rispetto a quella a 190°C. Inoltre, l’accreciuta decomposizione comporta una forte emissione di fumo, anche se la temperatura viene riportata di nuovo a 190°C. Le alte temperature non prevedono vantaggi, sono antieconomiche e aumentano il rischio d’incendio.

### ΘΕΡΜΟΚΡΑΣΙΑ ΛΑΔΙΟΥ

Διατηρείτε τη θερμοκρασία λαδιού στη φριτέζα μέχρι 190 βαθμούς Κελσίου. Υψηλότερες θερμοκρασίες θα αλλάξουν τη σύνθεση του λαδιού πολύ σύντομα και δεν ψήνετε γρηγορότερα. Η δυναμικότητα του λαδιού στους 205-210 βαθμούς Κελσίου είναι μόνο το ένα τρίτο της δυναμικότητάς του στους 190 βαθμούς Κελσίου. Επιπλέον η αυξημένη αποσύνθεση του λαδιού, σε θερμοκρασίες πάνω από 190 βαθμούς Κελσίου, κάνει το λάδι να καπνίζει άσχημα κι αν ακόμη κατεβάσετε τη θερμοκρασία κατόπιν πάλι στους 190 βαθμούς Κελσίου. Οι υψηλές θερμοκρασίες δε σας παρέχουν κανένα πλεονέκτημα, σας κοστίζει περισσότερα χρήματα και αυξάνουν τον κίνδυνο πυρκαγιάς.

**4.1. COOKING**

To ensure the quality of the food you cook in this appliance, follow the preparation instructions from the food manufacturer. When the appliance is not in use, the oil should be cooled and covered to prevent contamination.

**WARNING**  
**Dry fired heat tubes are extremely hot, will shorten the tank service life and will void your warranty.**

**4.2. Cooking tips**

- ✓ Always follow the food manufacturer’s directions.
- ✓ The lower the oil temperature, the longer the cooking time and the greater the fat absorption.
- ✓ NEVER overfill fryer baskets. Overfilling can result in soggy, greasy product.
- ✓ When removing baskets from the frypot, shake gently to remove excess oil.
- ✓ Never leave a basket over the fryer. The heat from the frypot will continue to cook the product.
- ✓ Oil/shortening quality can affect product quality. Keep salt and water away from the oil/shortening to maintain its life. Oil/shortening filtration removes crumbs from the oil which will also extend its life.

**Typical French Fry Cook Times (m:s)**



Fry Thickness	Temperature		
	350°F (177°C)	360°F (182°C)	370°F (188°C)
Thin	2:45	2:30	2:15
Medium	3:45	3:30	3:15
Thick	4:15	4:00	3:45

*This table is for reference only. Please refer to the product manufacturer’s specifications to determine exact cook temperatures and times.*

**4.3. BASKET LIFT OPERATION**

If the appliance is equipped with basket lifts, place the basket onto the basket lift prior to starting the timer(s). The basket(s) will be lowered into the frypot when a product key is pressed. At the end of the preset cooking time, the basket lift will raise the basket out of the frypot. Cancelling the cook by pressing and holding the cook timer button will raise the basket out of the oil. Cook timer keys L through 5 will operate the right-hand basket lift. Keys 6 through R will operate the left-hand basket lift.

**5. FRESH OIL TOP OFF FUNCTION**

To add fresh oil to the fry tank on demand, press and hold the  key. Release the  key when the desired oil level is reached in the tank.

Use the Left or Right key to top off the Left or Right vat, respectively for split vat models.

Manual top offs are not permitted while there is an active cook in process.

**6. AUTOMATIC OIL TOP OFF SYSTEM (OPTION)**

Pitco offers the “Automatic Oil Level Control” option (Auto-Top Off) to maintain the optimal oil level in your Pitco fryer. This optional system minimizes the need for the operator’s attention during busy cooking hours. The system maintains oil levels in the frying vat by adding small amounts of fresh oil when appropriate. Replenishment oil is drawn from a Jug In Box (JIB) located in one of the cabinets in a multiple vat build. Alternately, the JIB can be remotely located within nine feet of the fryer. The system can also accommodate a bulk oil system if equipped.

There are specific conditions when fresh oil will not be added to the vat by the automatic system:

- 1) Cook Cycle
- 2) Heating Cycle
- 3) Melt Cycle
- 4) Filtering Cycle
- 5) Control in the “OFF” state







## 7. QUICK STRAIN FILTERING

When the controller indicates the need to perform a “Quick Filtering” (as soon as business levels permit).  
 {For more thorough filtering/cleaning operations refer to the Preventative Maintenance Section 9 of this document or the separate controller manual that was provided with your appliance.}

### 7.1. NON-AUTO Filter models

**WARNING:** Before filtering ensure that filter pan is in place and empty. Wear proper personal protective equipment while filtering.

1. With Fryer ON and oil above the filter temperature, Pull the BLUE drain handle to initiate filter prompting on the control. The controller will display ‘FILTER?’
2. PRESS the ‘YES’ key, then press the TANK FILL key  to turn pump ON.
3. Follow the store procedures for cleaning and wait for the filter timer to end.
4. When filter timer ends, push the blue handle back in to close drain. The pump will refill the fry tank.
5. When bubbles appear in oil, press the TANK FILL key  to turn pump to OFF.
6. FILTER ONLY ONE TANK AT A TIME, the filter pan may overflow.

### 7.2 AUTO FILTER MODELS

**WARNING:** Before filtering ensure that filter pan is in place and empty. Wear proper personal protective equipment while filtering.

1. Ensure that oil temperature is above Filter Temperature. Press the Filter button  on the controller to initiate auto-filter prompting.
2. PRESS ‘YES’ key to begin auto-filter process and follow the prompts on the controller to continue the auto filter process.
3. Wait until the auto filter process completes.
4. When prompted by the controller, verify that the oil in the frypot has reached an appropriate level. If the filter pan is empty, press the ‘YES’ key to complete the filter process. If there is still oil in the filter pan, press the ‘NO’ key to run the pump for an additional 20 seconds.

NOTE: ‘NO’ may be selected for ‘Is vat full’ a maximum of three times. The fourth time that ‘NO’ is selected the fryer will turn OFF and display ‘POSSIBLE FILTER ISSUE – CHECK AND RESOLVE’. Press the ‘YES’ key to acknowledge.

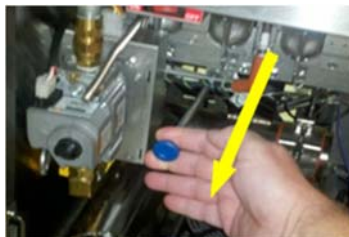





## 8. APPLIANCE SHUTDOWN

There are two shutdown modes of appliance operation: STANDBY and COMPLETE. The standby mode removes the ability of the appliances main burners to operate. Complete shutdown turns off the gas supply to the appliance. A STANDBY shutdown can be used during slow business periods. ALWAYS perform a COMPLETE shut down when the appliance will not be in use and unsupervised for an extended period of time. Refer to the following procedures to enter the appropriate shutdown mode.

### 8.1. STANDBY MODE

Press the  button to turn the computer OFF.

### 8.2. COMPLETE SHUTDOWN

1. Press the  button to turn the computer OFF.
2. Turn the ON/OFF knob on the gas valve clockwise to the OFF position
3. The appliance is now completely shut down and can be cleaned if desired.

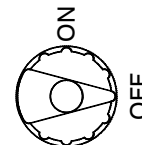

## 9. PREVENTATIVE MAINTENANCE

### 9.1. DAILY PREVENTATIVE MAINTENANCE

Performing the preventative maintenance steps below daily will keep your equipment safe and at peak performance. During the cooking process, oil/shortening may spill and splatter and requires immediate attention. Furthermore, during the cooking process, particles, crumbs and crackling collect inside the fry tank reducing product quality and decreasing oil/shortening life. If you are producing high quantities of fried food and/or frying heavily battered food, it will be necessary to perform these steps more than once a day.



#### WARNING

**Serious injury could result from direct contact with hot surfaces and/or oil. Always wear an apron and heat resistant gloves for skin protection and goggles for eye protection.**

#### 9.1.1. DAILY CLEANING

At least daily, a complete filter is required. Make sure a clean filter is installed every day.

For manual filtering refer to the following procedure:

1. Ensure that the filter pan is in place and empty. Turn the appliance OFF. Pull the blue drain handle to drain oil/shortening from the cooker tank into the filter pan.
2. Using a water dampened clean cloth, wipe the insides of the frypot to remove crumbs and debris. Scrub crumb ring in frypot with abrasive pad if needed. **REMOVE ALL MOISTURE** from the tank before proceeding to the next step.
3. Press the  key to turn the pump on. It is recommended to allow the oil to circulate for 5-10 minutes.
4. To refill the tank, push the blue drain handle in. Ensure that the oil/shortening level is to the level line. Additional oil may need to be added to the frypot
5. When the tank has completed filling, press the  key to deactivate the pump. The oil/shortening in the fryer is now filtered.
7. Clean the filter pan and replace the filter media following the procedures mentioned in this manual.

For Automated Filtering, refer to the following procedure:



Ensure that the oil temperature is above allowable filter temperature and that the filter pan is properly in place and empty before performing this procedure.

1. Turn the fryer 'OFF'.
2. Push and hold the key  to enter the Fryer Control Menu.

#### WARNING

**Ensure that the filter pan is in place and empty before proceeding. Failure to do this may result in an unsafe situation.**

## INSTALLATION & OPERATIONAL MANUAL

3. Press the #1 key. The control will display **TOGL OPN**.
4. Press the #6 key (YES). The drain valve will open and the oil will drain from the tank into the filter pan and the control will display **TOGL CLS**.
5. With the oil drained into the filter pan you may clean the fry tank. Using a water dampened clean cloth, wipe the insides of the frypot to remove crumbs and debris. Scrub crumb ring in frypot with abrasive pad if needed. **REMOVE ALL MOISTURE** from the tank before proceeding to the next step.
6. When cleaning has been completed, press the #6 key to close the drain valve. The control will display **TOGL OPN**.
7. To return the oil to the fry tank, press the L key. The control will display **TOGL ON**.
8. Press the #6 key (YES) to turn the filter motor on and begin returning the oil to the fry tank. The control will display **TOGL OFF**.
9. When the tank is full press the #6 key (YES) to turn the filter pump OFF. The control will display **TOGL ON**.
10. You can now exit the Fryer Control Menu by pressing the  ON/OFF or  Filter key.

You may want to reheat the oil in the fry tank and perform a full auto filter. Additional filtering procedures, settings and control functions can be found in the Control manual that was shipped with your fryer.

### 9.1.2.REPLACING THE FILTER MEDIA

Refer to the following procedure to replace the filter media if the appliance is equipped with a filter drawer. The diagram below shows a pan and associated parts. Additional filter types are available.

1. Detach the pickup tube from the filter pickup assembly by unscrewing it (counterclockwise), at the knurled fitting, from the threaded fitting on the filter screen.
2. Slide off the filter paper clip and remove used filter paper from filter screen. Clean and completely dry pan and pan components. Replace with new filter paper, ensuring that the hole in the paper is on the top, so that threaded fitting in filter screen protrudes through it.
3. Fold filter paper to the underside of the filter screen and replace filter paper clip.
4. Re-attach filter pickup tube to the filter screen by screwing it (clockwise) into the threaded fitting in filter screen.
5. Reinstall the filter pickup assembly into the filter system by placing the newly covered screen portion of the assembly into the filter pan and connecting the quick disconnect on the filter pickup assembly into white donut fitting on the left-hand side of the appliance. Ensure that it snaps tightly and securely into donut fitting.

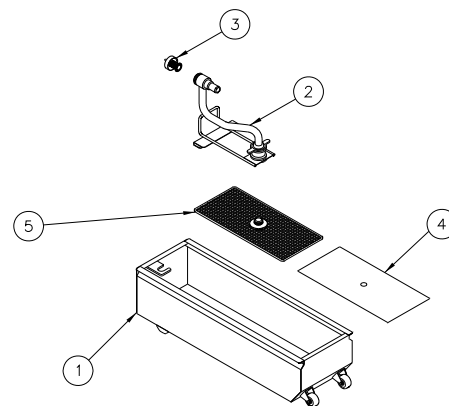

1. Filter Pan
2. Filter Pickup Assembly
3. Filter Strainer Cap
4. Filter Paper
5. Filter Screen

#### WARNING

The power supply must be disconnected before cleaning and servicing this appliance!

#### WARNING

The contents of the crumb catch and/or filter pan of any filter system must be emptied into a fireproof container at the end of the frying operation each day. Some food particles can spontaneously combust into flames if left soaking in certain oil/liquid shortening materials.

**9.1.3. APPLIANCE INSPECTION**

- ✓ Check that the high temperature limit and temperature probe are in the correct position and secured in place. (Refer to illustration on page 15 of this manual).
- ✓ Check that wires and cords are not frayed or loose in and out of the cabinet.
- ✓ Check around the appliance for loose parts or accessories that need to be secured or other foreign items (ex: Aerosol cans) that should be removed from the area.
- ✓ Check for oil/liquid shortening leaks around the inside and outside of the cabinet and around the appliance.

<b>WARNING</b> Serious injury could result from direct contact with hot surfaces and/or oil. Always wear an apron and heat resistant gloves for skin protection and goggles for eye protection.
<b>WARNING</b> Read the operation section of this manual prior to filling or operating the appliance.
<b>WARNING</b> DO NOT leave the appliance unattended during cleaning.

**9.1.4. CLEANING THE FRYPOT**

1. Follow the procedure from 9.1.1 (pages 25-26) appropriate to the appliance to turn OFF and drain the oil/liquid shortening. Allow the unit to cool, then perform the following procedure for cleaning the tank.
2. Remove baskets, tank rack and basket hanger for cleaning in pot sink, power soak sink or dishwasher.
3. Using the cleaning brush, crumb scoop and clean out rod, remove all the loose debris and scrub all tank surfaces.
4. For tougher carbonized oil/liquid shortening and carbon buildup, scrub tank using a Scotchbrite or other abrasive pad. **DO NOT** use steel wool.
5. Wipe residue with a clean water dampened cloth. Carefully dry and **REMOVE ALL MOISTURE** from the tank before returning oil/liquid shortening into the tank.
6. Clean and dry baskets, tank rack and basket hanger before reinstalling.
7. Finish following the procedure from 9.1.1 (pages 25-26) appropriate to the appliance for the steps after cleaning.

**9.1.5. CLEANING THE CABINET**

1. Wipe any spilled oil/liquid shortening, dust and lint from the cabinet exterior with a clean damp cloth and a mild food grade detergent. Be careful not to get any water or detergent in the oil/liquid shortening. Use a nonabrasive pad for tougher stains if needed.
2. Remove detergent from all surfaces.
3. Cleaning the interior cabinet requires a clean cloth to remove any oil/liquid shortening, dust, lint or filter powder (i.e.: Magnesol) from the interior of the cabinet.

**9.1.6. FILTER CLEANING**

1. Unscrew filter strainer cap from pickup tube and remove any crumbs from the slots. Use a clean cloth to remove any remaining crumbs and reattach.
2. Scrape all loose debris and crumbs from filter pickup assembly and filter pan with the filter scoop shovel.
3. Remove filter pickup and place in pot sink, power soak sink or dishwasher for cleaning. Be sure to rinse thoroughly and dry all surfaces before re-assembly.
4. Wipe the filter pan with clean damp cloth and a food grade detergent. If necessary, place pan in pot sink to rinse all the detergent from the surfaces.
5. **CAUTION** - Ensure that all parts and surfaces are completely dry before re-assembling and using.

## 9.2. WEEKLY PREVENTATIVE MAINTENANCE

Performing the preventative maintenance steps above on a daily basis will keep your equipment clean and safe. On a weekly basis these additional steps should be performed. Wear personal protective gear when performing preventative maintenance!

1. Turn the fryer off. Allow the oil/liquid shortening to cool to room temperature before pulling the fryer away from the hood. Hint: This maintenance may be ideal to perform on the day the oil/liquid shortening is being changed so no oil/liquid shortening is present in the tank or filter.
2. Disconnect the power cord(s), gas hose, retention lanyard and bulk oil line (if present).
3. Wearing your protective gear, pull the fryer away from the hood.
4. Check that vent hood drip cup is empty and not dripping oil/liquid shortening into the flue.
5. Check that the hood baffles are clean and not dripping oil/liquid shortening into the flue.
6. Clean the fryer sides, back and the flue area, it may be necessary to use a non-abrasive pad to scour and a putty knife to scrape the oil/liquid shortening buildup. With a clean damp cloth and food grade detergent wipe the area clean.
7. Wipe up any excessive oil/liquid shortening on the power cord(s) and gas hose with a dry cloth.
8. Check flue pipe for any foreign debris/object and remove if found.
9. Reattach power cord(s), gas hose, retention lanyard and bulk oil connection (if present) push fryer back under the hood.

## 9.3. MONTHLY PREVENTATIVE MAINTENANCE

Food debris and oil/liquid shortening can build up inside the tank. Performing the monthly preventative maintenance steps below will keep your equipment safe and at peak performance. If you are producing high quantities of fried food and/or frying heavily battered food, it may be necessary to clean these components more than once a month.

### 9.3.1. BOIL OUT PROCEDURE

Wear protective gloves and clothing when cleaning and draining the appliance. Oil/liquid shortening, water or steam may spatter and will cause injury to personnel.

1. Read "Section 3 OPERATION" of this manual prior to filling or operating the appliance.
2. Turn the appliance off. Drain all the oil/liquid shortening from the tank into a container and allow it to cool. The container must be large enough to hold the entire contents of the tank and must also be able to withstand 400°F (205°C) temperatures.
3. To drain the tank of manual models, drain the tank by pulling the blue handle out.
4. To drain the tank of automatic models, push and hold the  key to enter the Fryer Control Menu. Press the #1 key. The message `TOGL DPN` will display on the control.
5. Press the #6 key (YES). The drain will open and the oil will drain into the container. The control will display `TOGL DPN`.
6. Remove baskets, tank rack and basket hanger for cleaning.
7. Remove and discard any large debris inside the tank.
8. Close the drain valve. On manual models, the drain can be closed by pushing the blue handle in all the way. On automatic models, press the #6 key (YES). The drain will close, the control will display `TOGL DPN`.
9. Fill the tank with water and place the appliance into boil mode:  
Turn the appliance ON. As the water heats up, the controller will recognize that there is water in the tank and automatically enter boil mode. To enter boil mode manually, press the Temp Key then keys 2, 1, 2 for degrees F or 1, 0, 0. for degrees C. The display will read 'BOIL'.
10. Once the water reaches a simmer, follow the directions of the boil out product that you are using.

11. Scrub the inside of the tank using a cleaning brush safe for hot water. Care must be taken to remove all the foreign material on the tank, heating tubes, sidewalls and other components in the tank. Be careful not to loosen or damage the high limit or temperature probe during when scrubbing.

**NOTICE**

**DO NOT run water through the filter return system. This will damage the pump and void your warranty.**

12. Drain the water from the tank into a container that is large enough to hold the contents of the tank and is suitable for use with 212°F(100°C) water.

Manual models: pull the blue handle out. The drain will open.

Automatic models: push and hold the  key to enter the Fryer Control Menu. Press the #1 key. The message **TOGL OPN** will display on the control. Press the #6 key (YES). The drain will open; the control will display **TOGL CLS**.

13. Once the tank has cooled, rinse it thoroughly with clean, potable water.



14. Remove all remaining water and residue with a clean dry cloth.

15. Clean and dry baskets, tube rack and basket hanger before reinstalling

16. Close the drain valve and fill the cooker tank with oil/liquid shortening.

Manual models, push the blue handle in. The drain will close.

Automatic models, press the #6 key (YES). The drain will close; the control will display **TOGL OPN**.

To exit the Fryer Control Menu, press the ON/OFF key  or the Filter key .

17. You can now fill the tank with oil/liquid shortening.

### 9.3.2. TEMPERATURE CHECK

1. Use a high-grade pyrometer or digital thermometer suitable for temperature up to 380°F (182°C). Place the thermometer in the oil above the tip of the fryer's temperature probe with in 1" (2.54 cm) 25.4 mm). Be sure not to touch the heat tube since this will measure incorrect temperatures. Allow several minutes for the thermometer to equilibrate with the oil temperature.
2. Press the Thermometer key on the computer, and compare the actual temperature to the thermometer reading.
3. The two readings should be within a range of  $\pm 5^{\circ}\text{F}$  ( $\pm 2.7^{\circ}\text{C}$ ) of each other. If the two readings are not within the desired range, contact your local service representative or Technical Support at the number on the back of this manual.

#### 9.4. ANNUAL/PERIODIC PREVENTATIVE MAINTENANCE AND INSPECTION

This section should ONLY be performed by a qualified service technician as part of a regular kitchen maintenance program. This inspection should take place a minimum of once a year by an Authorized Service Technician recommended by Pitco. It may be necessary perform this inspection more than once a year.

#### WARNING

**The power supply must be disconnected before cleaning and servicing this appliance!**

##### 9.4.1.SAFETY EVALUATION

- ✓ Check power cord and plug.
- ✓ Check all exposed wiring connections, switches, and indicator lights.
- ✓ Check legs, casters, wheels, plate welds and ensure all nuts and bolts are secured.
- ✓ Check conditions of flexible gas line and verify fryer retention / lanyard system is in place.

##### 9.4.2.MECHANICAL INSPECTION

- ✓ Check frypot for oil leaks and excessive oil build up
- ✓ Check for oil migration (Clean as required)
- ✓ Check hood drain cup, ensure it is empty and not dripping into the flue.
- ✓ Check hood baffle for clean surface, oil/water condensate can drip on and into the flue.
- ✓ Check flue for foreign debris and hood down draft currents.
- ✓ Check drain/filtration system (if equipped) for leaks
- ✓ Check for missing fryer parts, i.e.: cover strips
- ✓ Check for missing fasteners

##### 9.4.3.TEMPERATURE CONTROL SYSTEM

- ✓ Check electrical connections and harnesses
- ✓ Check temperature probes and limits for carbon build up and plating. Clean as required
- ✓ Check proper mounting of probes and sensors and all fasteners are secure.
- ✓ Check thermistor probe resistances for stability.
- ✓ Check DVI Drain Valve Interlock drops out controller.
- ✓ Check Controller/thermostat features to ensure they are functioning.
- ✓ Check Temperature Calibration

##### 9.4.4.FILTER SYSTEM

- ✓ Check electrical connections and harnesses.
- ✓ Check IEC power cords are fully engaged and secure.
- ✓ Check for any air or oil leaks and for excessive oil build-up.
- ✓ Check O-Ring on filter pickup tube and replace as needed.
- ✓ Check filter strainer on pickup tube.
- ✓ Check operation of drain valve and DVI drain valve interlock.
- ✓ Check operation of return oil valve and its pump switch.
- ✓ Check operations of flush hose quick disconnect (if equipped), clean and lubricate as needed.
- ✓ Check all hardware in filter pan.
- ✓ Check filter operation by filtering the fryers.
- ✓ Check pump motor amp draw compare to nameplate amperage.
- ✓ Check pump and motor, clean any excess oil from pump assembly.
- ✓ Check all filter hoses for leaks and integrity.

**9.4.5. GAS COMBUSTION SYSTEM**

- ✓ Check for gas leaks.
- ✓ Check and clean vent tube on gas valve pressure regulator.
- ✓ Check burners, clean debris and grease from pilot and pilot orifice tips.
- ✓ Check self cleaning burner system (if equipped) that it activates when the appliance is turned on and NOT during normal cooking & idle periods.
- ✓ Check and adjust burner manifold gas pressure to nameplate reading.
- ✓ Check incoming gas pressure to the appliance under static and dynamic conditions.
- ✓ Check ignition system and adjust pilot flame as required.
  - Check flame sensor reading.
  - Check gap spacing and clean igniter.
- ✓ Recheck for gas leaks after inspection.

**9.4.6. CONTROL BOX & ELECTRICAL COMPONENTS**

- ✓ Verify that all components (transformer, terminal block, relays, drain switches, etc...) are in good condition. Verify that wires are tight and in good condition.
- ✓ Verify enclosures are free of leaks. Check for signs of oil or water stains and wet surfaces.
- ✓ Verify that the covers and panels are intact and provide a safe condition. Check for loose parts.
- ✓ Verify power cord is in good condition. Check for frayed or exposed wires. Verify that the insulation is in good condition and the attachment to the unit is tight.

**9.5. VENTILATION HOOD**

Proper ventilation hood operation is very important for the correct operation of this appliance and the safety of personnel. The ventilation hood should be inspected at the time of installation of this appliance to ensure that it will operate properly in conjunction with the appliance. A regular schedule of examination in accordance with ANSI/NFPA 96 latest edition and/or local codes must be followed.

## 10. TROUBLESHOOTING

### 10.1. POWER FAILURE

If electric power is removed for any reason, the appliance will shut down.

Wait five minutes after the power is restored before attempting to restart the appliance. This will allow time for any gas that may have accumulated in the burner or tubes to dissipate.

To restart the appliance, follow the appliance start up procedure outlined in “Section 4” of this manual.

#### CAUTION

**DO NOT attempt to operate this appliance during a power outage.**

### 10.2. HIGH TEMPERATURE LIMIT SWITCH

This appliance is equipped with a high temperature limit switch. The high temperature limit switch will stop the appliance from functioning if the oil temperature in the frypot reaches an unsafe temperature. In the event that the high temperature limit has tripped, please refer to the following procedure to reset the switch.

**NOTE:** The high limit reset button is located behind the gas valve and is not readily visible to the user.

- a. Turn the appliance off.
- b. Allow the appliance ample time to cool to room temperature.
- c. Add oil/liquid shortening to the frypot as needed.
- d. Press the high temperature reset button.
- e. The high limit switch is now reset and the appliance is ready for startup.





#### WARNING

**DO NOT add oil/liquid shortening to the tank until it has been given ample time to cool down. Failure to do so may result in damage to the appliance and/or injury to the operator.**

### 10.3. DRAIN VALVE INTERLOCK

Your appliance is equipped with a drain valve interlock circuit; the appliance will stop heating if the tank drain valve is opened. The appliance will turn off, and scroll a message “DRN TRN OFF”. Refer to the following procedure to resume operation after the drain valve interlock is tripped.

1. Turn the computer OFF (if not already OFF).
2. Close the tank drain valve:  
Manual models: push the blue handle in. The drain will close.  
Automatic models: press and hold the  key to enter the Fryer Control Menu. Press the #1 key: the control will display **TOGL OPN**. Press the #6 key to open the drain valve. The control will display **TOGL CLS**. Press the #6 key to close the drain valve. The control will display **TOGL OPN**. If the drain valve does not close it is possible that there is an obstruction in the drain line. Allow the appliance to cool and, wearing PPE, clear the obstruction from the drain. Once the obstruction is cleared, repeat the previous steps to ensure that the drain valve is closed. If there is no obstruction and the drain valve still will not close there may be a hardware malfunction. Call Pitco Technical Support at the number provided in this manual. Otherwise, to exit the Fryer Control Menu, press the ON/OFF key  or the Filter key .
3. Fill the tank with oil/liquid shortening.
4. Turn the computer ON and resume normal operation.



**10.4. SELF CLEANING BURNER SYSTEM**

If your appliance is equipped with the self cleaning burner system, the appliance should behave as outlined in the table below. A cleaning cycle will execute every time the appliance is turned “ON” from an “OFF” state. The thermal cut out switch is designed to disable the appliance if the Self Cleaning Burner System malfunctions and remains activated for an extended period or if there is a downdraft into the flue or a blocked flue situation.

Event	Duration	Indication
Turn appliance “ON”	N/A	Control Illuminates, pilot sparks and ignites. Pre-Purge pulse is initiated.
Pre-Purge Pulse	2 seconds	Appliance operates briefly and stops. Pilot remains lit.
Interwaiting period 1	5 seconds	Appliance does not operate. Pilot remains lit.
Cleaning Pulse*	6 seconds	Main valve operates, lighting main burners. SCBS valve operates, feeding gas to the SCBS Arm. The SCBS arm ignites, initiating a brief burn at the main burner orifice of each burner.
Interwaiting period 2	8 seconds	The Main and SCBS valves de-energize for this period. The pilot remains lit.
Normal operation resumes	N/A	The appliance operates normally and begins to heat up. The SCBS Valve remains de-energized until power to the appliance is recycled. There is no flame on the SCBS Arm. There is no burn at the main burner orifices.

\* If flame sense on the pilot is lost during the SCB cycle, the SCB cycle will start over.

**10.5. RESETTING THE SELF CLEANING BURNER ROLL OUT SWITCH**

1. Turn the appliance off and allow ample time for the appliance to cool to room temperature.
2. Press the SCBS roll out switch reset button. The reset button is located behind the door at the top of the main burners.
3. The SCBS roll out switch is now reset and ready for startup.
4. If the SCBS roll out switch continues to trip, have the appliance inspected by an Authorized Professional.

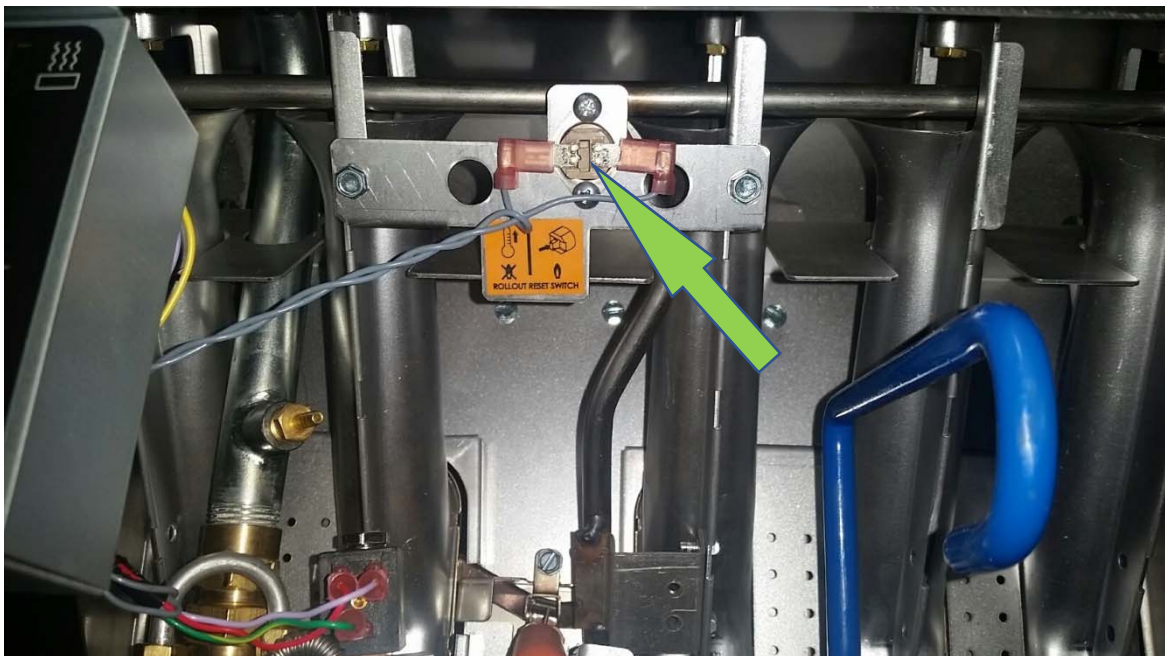

**SCBS Roll Out Switch Location**

**10.6. TROUBLESHOOTING CHARTS**

**10.6.1 FRYER TROUBLESHOOTING CHART**

<b>Problem</b>	<b>Possible Causes</b>	<b>Corrective Actions</b>
Computer Controller display doesn't light.	No power to appliance.	Check main building power supply.
	Circuit Breaker/GFI tripped.	Reset circuit breaker/GFI.
	Power Cord loose or not connected.	Connect power cord. Verify that power cord is plugged at the rear of the appliance.
	Fuse blown.	Contact Authorized Service Company.
	Transformer Defective.	Contact Authorized Service Company.
	Defective Controller.	Contact Authorized Service Company.
Controller is on and appliance will not heat up.	Computer is in Melt Cycle	Allow time for unit to heat up.
	Gas not turned on/ connected.	Turn the gas on/connect gas to the appliance.
	SCBS Roll out switch has tripped.	Allow the appliance to cool and reset the SCBS Roll out switch.
	High temperature limit has tripped.	Allow the appliance to cool and reset the High Temperature Limit switch.
Appliance will not maintain temperature properly.	Faulty temperature probe.	Contact Authorized Service Company.
	Incorrect gas pressure.	Adjust the gas pressure or contact Authorized Service Company.
	Faulty High temperature limit.	Contact Authorized Service Company.
Computer display shows off, cannot be turned on.	Faulty computer	Contact Authorized Service Company.

**10.6.2 FRYER TROUBLESHOOTING CHART (if equipped)**

<b>Problem</b>	<b>Possible Causes</b>	<b>Corrective Actions</b>
Filter pump does not activate	The filter pump circuit breaker has tripped.	Reset the circuit breaker.
	The thermal overload on the pump motor has tripped.	Allow the motor to cool and reset the thermal overload on the motor.
Oil/Liquid Shortening is returning to the tank slowly or not at all.	Dirty filter paper/too much debris on filter paper.	Change filter paper/clean debris from filter paper*.
	Strainer cap is dirty/clogged.	Remove, clean and reinstall strainer cap*.
	Filter pan is not properly installed/filter pickup is not completely pushed in.	Check filter pan for proper installation/push filter pickup in completely*.
Excessive air bubbles occur while oil is being returned to the fry tank.	Pick-up tube screen in the filter pan is not tight.	Tighten the tube screen on the filter pickup assembly*.
	Pick-up tube screen cap is loose or missing.	Tighten or install the Pick-up tube screen cap*.
	Filter pan is not properly installed/filter pickup is not completely pushed in.	Check filter pan for proper installation/push filter pickup in completely*.
Drain valve is closed but the computer controller still displays 'DRAINING'.	The blue drain valve handle is not pushed in all the way.	Ensure that the blue drain valve handle is pushed in all the way.
	Improperly adjusted or defective drain switch	Contact Authorized Service Company

\* Wait for the oil and/or appliance to cool to room temperature before attempting these corrective actions.

**10.6.3 COMPUTER CONTROLLER DISPLAYS**

Below is a list of common computer controller displays and guidance. For additional computer controller displays and information concerning them, refer to the controller manual that was shipped with your appliance.

Display	Problem	Action
OFF	Controller is OFF	Press [I/O] key to turn controller ON
MELTING LIQUID	Oil/shortening temperature is low. Fryer is slowly heating.	Wait for appliance to heat up.
MELTING SOLID	Oil/shortening temperature is low. Fryer is slowly heating.	Wait for appliance to heat up.
HEATING	Oil/shortening temperature is low. Fryer is heating.	Wait for appliance to heat up.
READY	Oil/shortening is at temperature and ready to cook.	Perform cooking activities as needed.
DRAINING TURN OFF	Drain valve is open while controller is on.	Turn off appliance. Close drain valve before turning appliance back on.
HEAT FAILURE	Ignition system has locked out.	Refer to Fryer Troubleshooting section.
PROBE OP OPEN	Incorrect probe reading.	Contact a qualified service technician.
HIGH TMP	Oil/shortening has reached an unsafe temperature.	Turn off appliance. Allow ample time for appliance to cool before turning on.
	Incorrect probe reading.	Contact a qualified service technician.
SYSTEM FAILURE	Temperature probe is shorted.	Contact a qualified service technician.
POLISH NOW	This message indicates that oil in the vat is in need of polishing	Operators may (depending on settings) polish now, or defer the polish filter operation for a later time.
COMMLINK FAILURE	This message indicates that the computer has lost communication with the autofilter control board and oil management operations are suspended. Normal cooking activities are unaffected.	Contact a qualified service technician.
FILTSDOON	This message shows when the number of cooks since the last filter operation is greater than the Cook Counts Allowed Value.	Perform a filter operation as soon as business levels permit.
LOW JIB JIBEMPTY	Indicates that the JIB is low or empty.	If the JIB EMPTY message is displayed, the operator should replace the empty JIB with a new, full JIB. Refer to the Control Manual shipped with your fryer to clear this message.



## Original Instructions

Annual service to this appliance by an authorized person is recommended. Do not modify this appliance: servicing must only be carried out by an authorized person. For service and parts, minor adjustments, fault finding, or if this appliance cannot be adjusted to operate correctly, contact:

In the event of problems with or questions about your order, please contact the Pitco Frialator factory at:  
+1 (603) 225-6684 World Wide  
Website Address: [www.pitco.com](http://www.pitco.com)

In the event of problems with or questions about your equipment, please contact the Pitco Frialator Authorized Service and Parts representative (ASAP) covering your area, or contact Pitco at the numbers listed to the left.

MAILING ADDRESS – P.O. BOX 501, CONCORD, NH 03302-0501  
SHIPPING ADDRESS – 39 SHEEP DAVIS RD., PEMBROKE, NH 03275