



# MAINTENANCE MANUAL

---

## PRECIPAN™ INTELLIGENT BRAISING PAN

### MODELS:

VPP28

VPP40



Model VPP28 with Strainer Accessory



Model VPP40 with Strainer Accessory

### WARRANTY

To ensure the guarantee on this equipment, you should comply with the MANUFACTURER'S INSTRUCTIONS in this manual. However if you cannot undertake the required maintenance operations, our installation and service network is available to provide you with a personalized contract.

### WARNING

The product delivered to you complies with current standards. If any modifications are made the manufacturer cannot accept any responsibility whatsoever. The manufacturer cannot be held responsible in the event of an incorrect use of the appliance. Keep your documents. *Translation of the original manual.*

TECHNICAL SERVICE AND PARTS ASSISTANCE - US: 1-800-814-2028 | CANADA: 1-800-444-4764

# BRAISING BRATT PANS

## PreciPan™

# ELECTRIC

<b>1. ELECTRICAL DIAGRAMS.....</b>	<b>2</b>
1.1 ELECTRICAL CLASSIFICATIONS.....	2
1.2 WIRING SCHEMATICS.....	3
<b>2. PROGRAMME SETTINGS.....</b>	<b>6</b>
2.1 SETTING THE SOFTWARE LANGUAGE.....	6
2.2 BRAISING PAN PARAMETERS.....	6
2.3 SCREEN CARD SETTINGS.....	8
<b>3. MAINTENANCE PROGRAMMES.....</b>	<b>9</b>
3.1 ELECTRONIC CARDS.....	9
3.2 POSITION OF THE MICRO SWITCHES ON A FASTPAD 2 POWER ASSEMBLY.....	10
3.3 SOFTWARE CONTROL.....	10
3.4 UPDATING THE SOFTWARE.....	10
<b>4. MAINTENANCE SCREENS.....</b>	<b>12</b>
4.1 ACCESS TO THE MAINTENANCE SCREENS.....	12
<b>5. HYDRAULIC DIAGRAMS.....</b>	<b>14</b>
5.1 STANDARD VERSION.....	14
<b>6. OPERATING FAULTS.....</b>	<b>15</b>
6.1 INSTRUCTIONS IN CASE OF SOFTWARE ANOMOLY.....	18
<b>7. PREVENTIVE MAINTENANCE.....</b>	<b>19</b>
7.1 LIST OF ACTIONS.....	19
7.2 ADJUSTING FREQUENCY INTERVENTION MAINTENANCE, USAGE RATE PER DAY.....	19
7.3 RE-INITIALISATION OF THE MAINTENANCE COUNTER.....	20
7.4 CONNECTING THE TERMINALS TO THE HEATING ELEMENTS.....	20
<b>8. PROCEDURES FOR CHANGING COMPONENTS.....</b>	<b>22</b>
8.1 LOCATION OF THE TECHNICAL COMPONENTS.....	22
8.2 ACCESS TO COMPONENTS.....	22
8.3 CODER.....	23
8.4 PRECIPAN FASTPAD 2 INTERFACE (SCREEN CARD).....	23
8.5 SCREEN SUPPORT.....	24
8.6 PRECIPAN FASTPAD 2 POWER CARD (complete, with its enclosure).....	24
8.7 FLOW REGULATOR.....	25
8.8 LID SWITCH.....	25
8.9 TANK RAM.....	26
8.10 BASKET LIFT RAM.....	26
<b>9. CHECKING THE TEMPERATURE SENSORS.....</b>	<b>27</b>
9.1 PT100 PROBE.....	27
<b>10. ADJUSTMENT TANK / LID.....</b>	<b>28</b>
10.1 LEVELLING THE TANK / CHASSIS.....	28
10.2 ADJUSTING THE LIDS COUNTERBALANCE.....	29
<b>11. RECOMMENDED (WEAR) AND FRONT LINE SPARE PARTS.....</b>	<b>30</b>



## 1. ELECTRICAL DIAGRAMS

### 1.1 ELECTRICAL CLASSIFICATIONS

Designation of common parts

REF.	DESIGNATION	CHARACTERISTICS	QUANTITY	CODE
Af	FastPAD 2 screen card		1	156 817
Ar	FastPAD 2 UL Precipan power assembly		1	309 712
-	Relay bar		1	309 663
-	Coder		1	309 632
Bd	Flow meter		1	314 388
Bf	Tank base probe		2 or 3	301 506
BSb	Tank probe		1	301 504
Bsc	Core probe	Rotisserie 4.5 Ø x 100mm	1	301 474
	Core probe terminal strip		1	401 477
	Silicone cover		1	366 554
F1	Fuse 3.15 Amps		1	309 407
F2	Fuse 1 Amps		1	309 789
F4	Fuse 0.2 Amps fast		1	300 787
F5	Fuse 3.15 Amps		1	309 407
Fc1 – Fc2 – Fc3	Manual resetting 320°C thermostat		2 or 3	301 066
Fta	Glass fuse 4 Amps		1	300 801
Ftco	Fuse 4 Amps FSF		1	306 963
Mt1 – Mt2	Technical fan		2	304 297
Sbr	Reed detector for lift arm	Basket lift	1	300 676
Scd - Scm	Snap Action Switching		2	300 804
Scu	Tank position switch		1	156 255
Scv	Lid position switch		1	300 678
Ta	Supply interrupter		1	308 351
Tco	415 VA Transformer		1	308 499
Vc	Tank ram		1	156 823
Vp	Lift arm ram	Basket lift	1	156 824
Xa	Supply terminal		1	-
Yd – Yv - Yef	3 way solenoid valve 3 x 15 litres/min	Standard version – Cold water	1	156 865
Yec	Single solenoid 15 litres/min	Hot water	1	156 864
Za	Supply filter		1	309 639

REF.	DESIGNATION	VBPT10E	VBPT15E	CODE
R1, R2, R3	Armoured elements 4650 W	6 (480-240V)	9 (480-240V)	302 294
	Armoured elements 4650 W	6 (208V)	9 (208V)	302 278

List of contactors

REF.	DESIGNATION	BPT10E	BPT15E	CODE
Kp	Main contactor	1 (480V)	-	300 700
		1 (208-240V)	1 (480V)	300 702
Kr1, Kr2, Kr3	Heating contactor	-	1 (208-240V)	300 798
		2 (480V)	3 (480V)	300 697
		2 (240V)	3 (240V)	300 698
Zs	Interference suppressor	2 (208V)	3 (208V)	300 699
		1 (480V)	-	300 769
		1 (208-240V)	1 (480V)	407 002
Zr1, Zr2, Zr3	Interference suppressor	-	1 (208-240V)	300 799
		2	3	300 769



**VULCAN**

A division of ITW Food Equipment Group LLC  
P.O. Box 696  
Louisville, KY 40201

**1.2 WIRING SCHEMATICS**

**1.2.1 ENTRY SCHEMATICS**

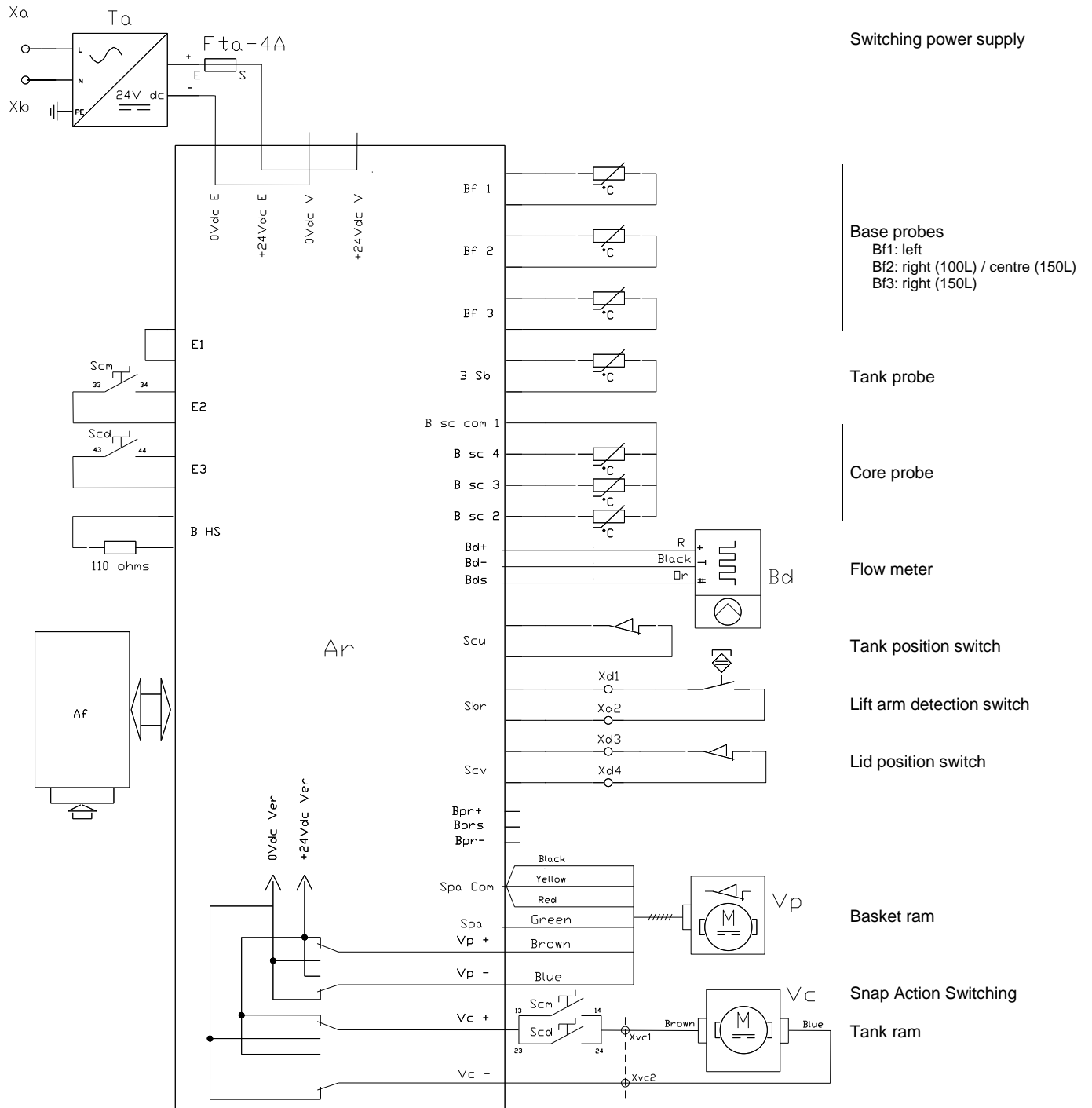

1.2.2 OUTLET SCHEMATIC

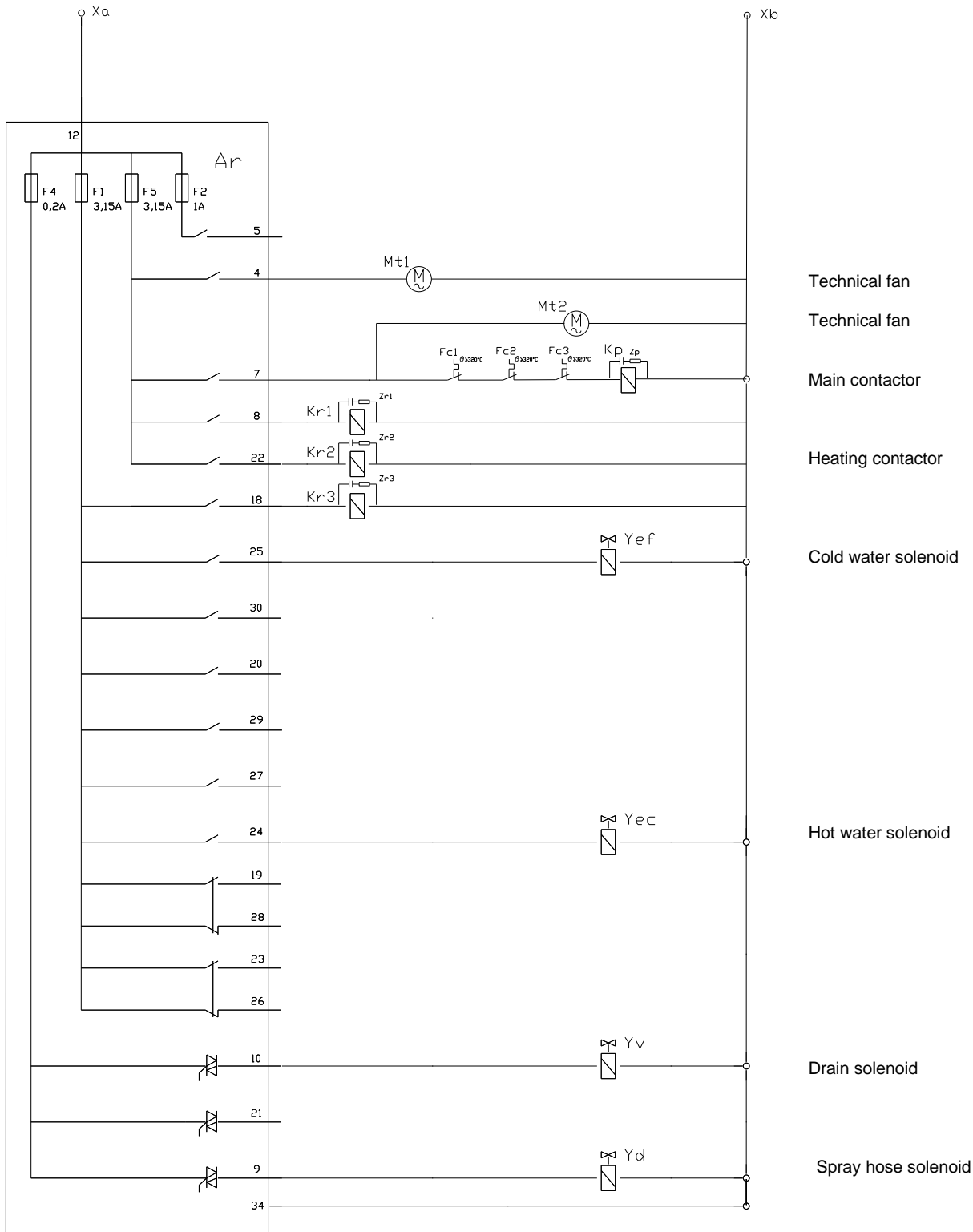

**VULCAN**  
A division of ITW Food Equipment Group LLC  
P.O. Box 696  
Louisville, KY 40201

1.2.3 POWER WIRING 208-240V

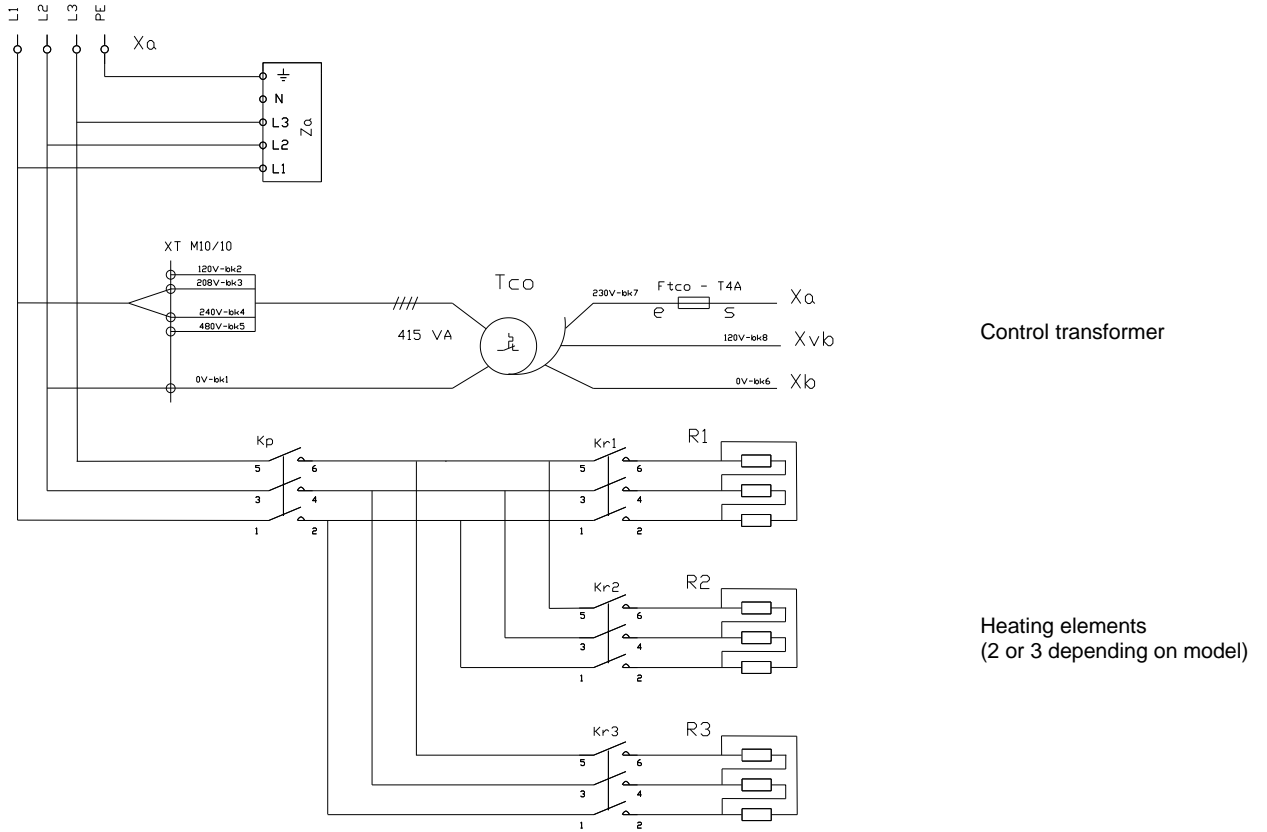

1.2.4 POWER WIRING 480V

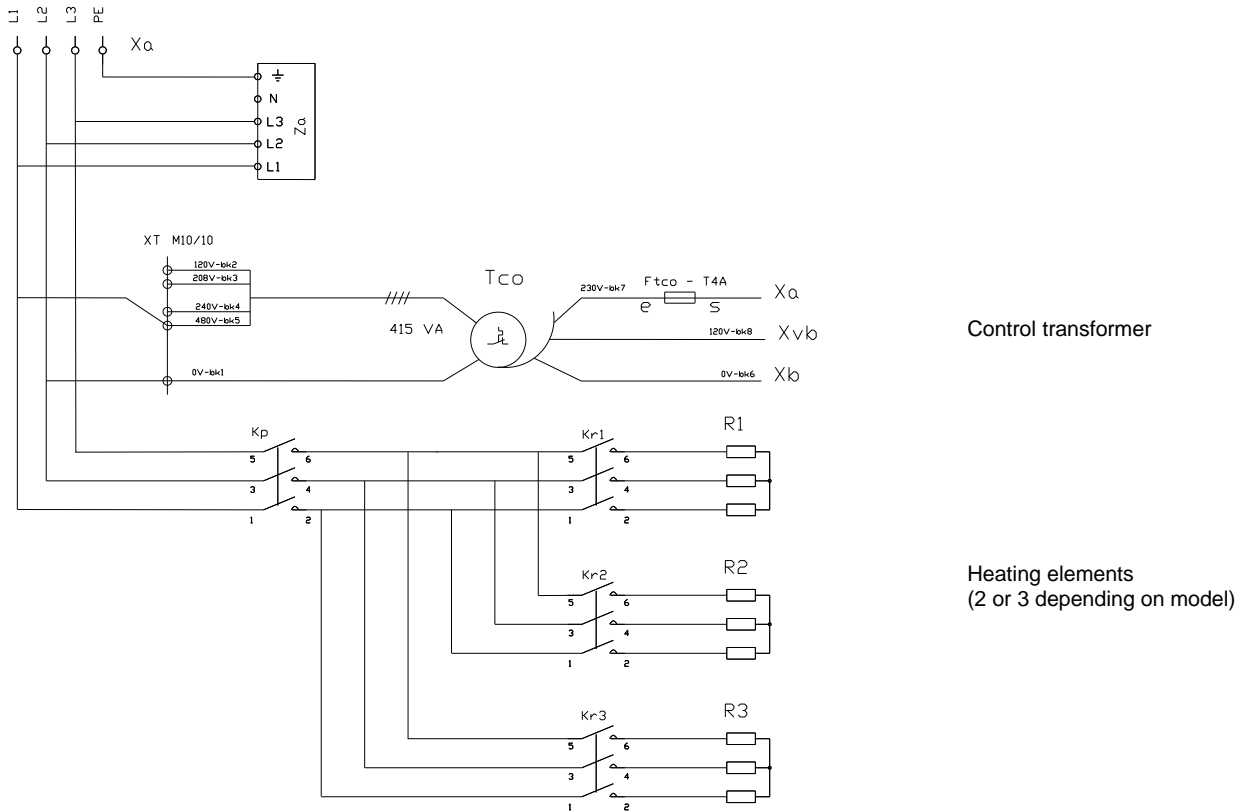

**VULCAN**  
A division of ITW Food Equipment Group LLC  
P.O. Box 696  
Louisville, KY 40201

## 2. PROGRAMME SETTINGS

The following operation is necessary when changing the FastPAD 2 power assembly board, front panel board, or changing versions of the FastPad software.

Before programming check the software is in the local language and change if necessary.

### 2.1 SETTING THE SOFTWARE LANGUAGE

- Select the "SERVICE" menu
- Select the "Client parameters" screen
- Enter the password « CHEF »: « Permanent » (lower or uppercase)
- Validate "V": When finished, if the code is correct access the menu if not re-enter the PIN number.
- Modify the programme language if necessary (Fr : French by default)
  - \* Select the zone of the value to be changed
  - \* Adjust the value using the coder knob



### 2.2 BRAISING PAN PARAMETERS

- Select the "SERVICE" menu
- Select the "Technician parameters" screen
- Enter the password: « SAVB »
- Validate "V": When finished, if the code is correct access the menu if not re-enter the PIN number.
- Reconfigure the appliance
  - \* Select the zone of the value to be changed
  - \* Adjust the value using the coder knob



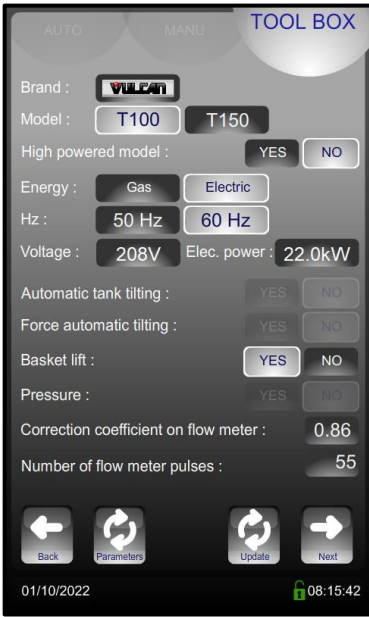

- Commercial brand of the appliance
- Model: Unit capacity
- Export historic error messages to USB stick (Excel compatible format) ←
- Export historic counter data to USB stick (Excel compatible format) ←
- Core probe calibration ←
- Basket lift
- Flow meter adjustment parameter
- Flow meter signal frequency



**Error message history**

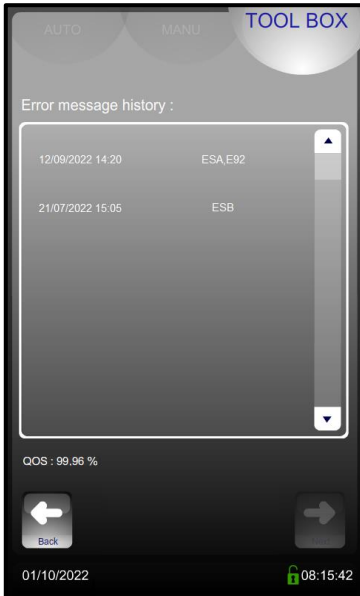

- Displays the list of error messages in the order they appeared

Counter listing ←

- Communication signal quality screen card/power card
- Pressing « Return » takes you back to the previous screen

**Counters**



**Counters**

CPT00	Duration of operation in total = SWITCHED ON (excludes cooking cycles)
CPT01	Duration of cooking in Bratt pan mode
CPT02	Duration of cooking in Boiling pan mode
CPT03	
CPT04	
CPT05	Not used
CPT06	Duration (°) or T° electronics > 70°c cumulative
CPT07	Duration total functioning IN CYCLE (all modes)
CPT08	Number of lid openings
CPT09	
CPT10	Volume of water flow meter (litres)
CPT11	Number of cycles S7 / Rel13 - Safety
CPT12	Duration of operation S7 / Rel13 (contact closed) - Safety
CPT13	Number of cycles S8 / Rel10
CPT14	Duration of operation S8

CPT15	Number of cycles S22
CPT16	Duration of operation S22
CPT17	Number of cycles S18
CPT18	Duration of operation S18
CPT19	Number of cycles S30 / Rel20 – condenser solenoid
CPT20	Duration of operation S30 / Rel20 - condenser solenoid
CPT21	Number of cycles S10 - drain solenoid
CPT22	Duration of operation S10 - drain solenoid
CPT23	Number of cycles S9 – spray hose solenoid
CPT24	Duration of operation S9 – spray hose solenoid
CPT25	Number of cycles relay Vp+
CPT26	Number of cycles relay Vp-
CPT27	Number of cycles relay Vc+
CPT28	Number of cycles relay Vc-



**VULCAN**

A division of ITW Food Equipment Group LLC  
 P.O. Box 696  
 Louisville, KY 40201



## 2.3 SCREEN CARD SETTINGS

These screens are common to several types of unit. After sales provide a non-product specific unit but it will be configured automatically when connected to the equipment in question.

This configuration is irreversible. Once a screen has been programmed to control an appliance it cannot be fitted to any other type of equipment. If necessary it must be returned to the factory for re-initialisation.

Required for configuration: a **blank FastPad USB stick**, or **blank USB stick** with the following characteristics:

- **Max capacity = 32 Gb – Formatted for FAT32 (Default unit allocation size = 4096 bytes) or formatted for FAT (Default size = 32 Kb).**
- The stick need not be empty but a minimum of 5 Mb of free space is required; Files already on the USB stick will not be erased (But always back up your personal data). Temporary files will be written but they can be erased afterwards.

Follow these steps after installing the new screen on the appliance by following the instructions in the paragraph “Screen board”, and chapter “Component change procedure”:

- Connect a USB stick (as defined above) to the USB port of the appliance.
- Turn the appliance on.
- Select the language on the installation screens (2 available versions: French or English).
- Select which type of appliance the screen will be configured for and confirm by pressing “OK”.
  - \* If the appliance does not match, or no configuration is found, turn off the power and check the position of the “micro switches” located on the FastPAD 2 power unit (see “Position of the micro-switches” in the “Maintenance program” chapter).
  - \* If necessary, ensure that the power assembly and/or the communication between the various circuit boards is working properly (see “Maintenance program” chapter).
- Wait for the configuration phases to automatically run through.
- When the message « Installation complete » is displayed, press “OK” to start the interface.
- Remove the USB stick
- Follow the “Setting the appliance” instructions to configure the interface.

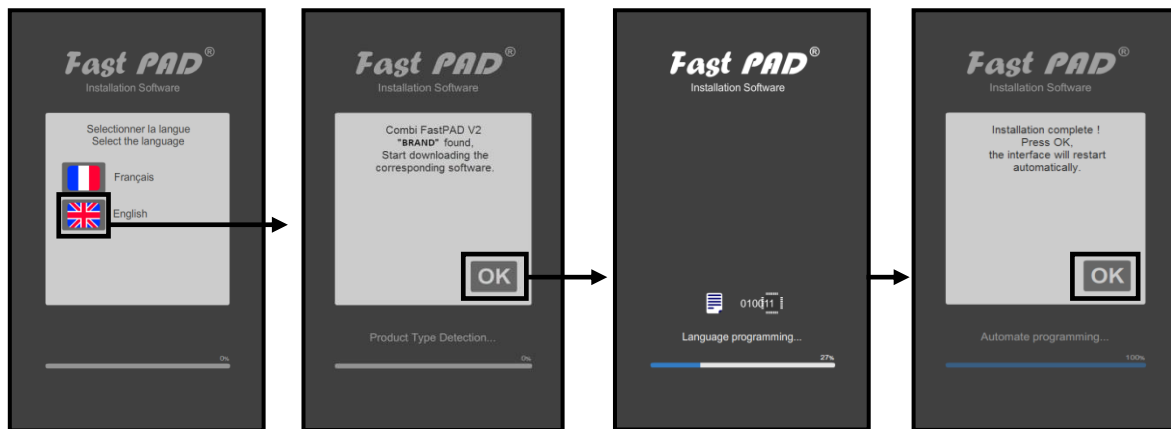

**3. MAINTENANCE PROGRAMMES**

**3.1 ELECTRONIC CARDS**

The state of the LEDs represents the communication between the 2 electronic cards and helps with diagnostics in the event of a breakdown.



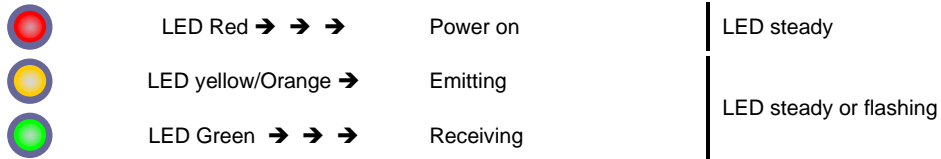





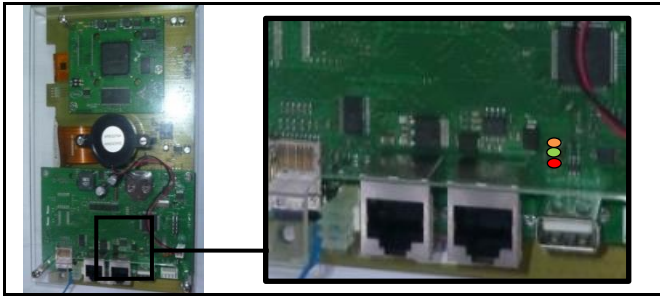

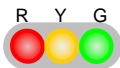
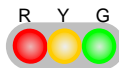
Significance of the LEDs on the FastPAD 2 power assembly and the FastPAD screen card:



A flashing LED is considered active as is a steady one.

Diagnostic of electronic faults:



FastPAD screen card	FastPAD 2 power assembly	Diagnostic	Actions
		- FastPad 2 Power assembly OK - FastPad screen OK	- Everything working normally
		- Supply failure	- Check the power between terminals 1 and 3 on the FastPad power assembly
		- Communication problem with the FastPAD screen card	- Replace the FastPAD screen card and/or the interconnecting cable
		- FastPad 2 UC power card defective	- Replace the FastPAD 2 power assembly
		- Screen not working	- Replace the FastPAD screen card
		- Cable linking FastPAD screen to - FastPAD 2 power assembly	- Replace the link cable between the cards

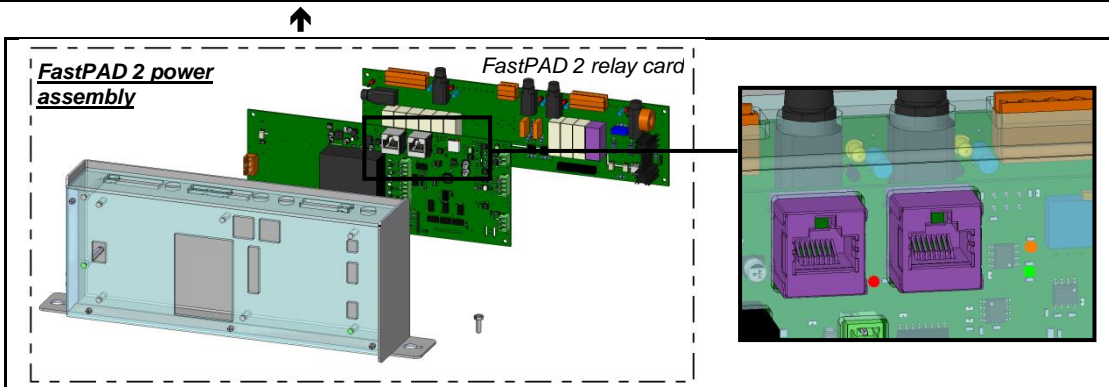

**3.2 POSITION OF THE MICRO SWITCHES ON A FASTPAD 2 POWER ASSEMBLY**

The position of these micro-switches ensure automatic recognition by the interface of the type of unit so appropriate software is installed (after sales or initialization)

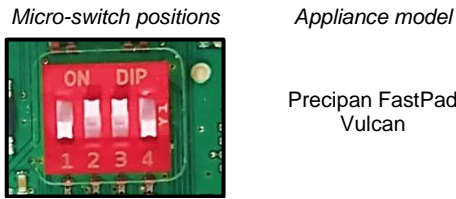

**3.3 SOFTWARE CONTROL**

The current software is visible in the "SERVICE" tab next to the unit's serial number. Each card is identified with its software tag:

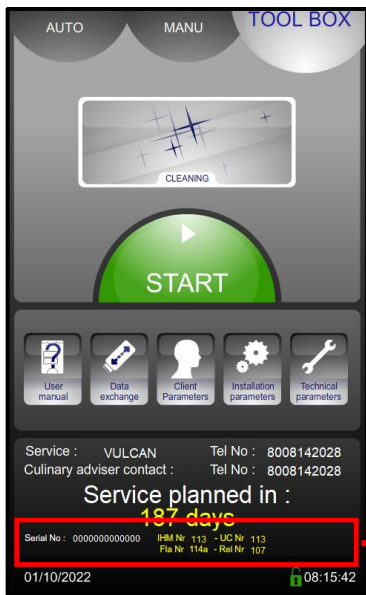

**Screen card sub assembly**  
**IHM - Fla:** IHM – Flash card  
**UC:** UC card  
 Screen support card

**Power carte**  
 Rel : Ensemble de puissance

Check the following numbers according to their corresponding update file numbers:

Standard update file labels :  
 MAJ\_FPV2\_IHMwww\_UCxxx\_FLAYyy\_RELzzz\_GTVvv  
 IHM Nr www  
 UC Nr xxx  
 Fla Nr yyy  
 Rel Nr zzz

**IHM Nr 113 - UC Nr 113  
 Fla Nr 114a - Rel Nr 107**

**3.4 UPDATING THE SOFTWARE**

Regular software updates ensure that the customer and/or technician can access the latest product developments and improvements. The technician will be alerted when an update is available via the "WebAstech" software, or through distribution of "software info". Before updating, check that the software is in the appropriate language and change if necessary.



**Attention:**  
 It is vital that the electrical supply is not switched off whilst loading software.  
**The USB stick must not be removed whilst loading software**  
 The appliance cannot be used whilst loading software

**3.4.1 USB STICK**

Required for configuration: a **blank FastPad USB stick, or blank USB stick** with the following characteristics  
 Max capacity = 32 GB -Formatted in FAT32 (Default allocation size = 4096 bytes) or formatted in FAT (Default allocation unit size = 32 kilobytes).

**3.4.2 SOTWARE FILE UPDATE**

Download the software update file "CVxxx-SW.zip" from the WebAstech Vulcan maintenance site. Unzip the file. Copy the file to the USB stick and run it:  
 ex : "MAJ\_FPV2\_IHM229\_UC224b\_FLA221\_REL114\_GTW016.exe"  
 The files will be created automatically on the USB stick. The USB stick must only contain:

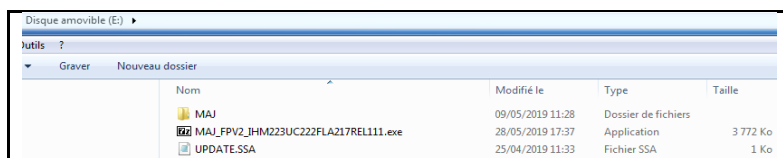

**VULCAN**  
 A division of ITW Food Equipment Group LLC  
 P.O. Box 696  
 Louisville, KY 40201

## 3.4.3 PROCEDURE

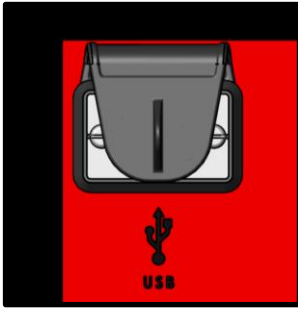

Switch the appliance on. If necessary, stop preheating.  
Put the USB stick (with the new software version) into the USB port.  
The USB port has a protective silicone cover.  
It is located under the control panel

**Attention !**

Refit the protective cover if the socket is not being used.

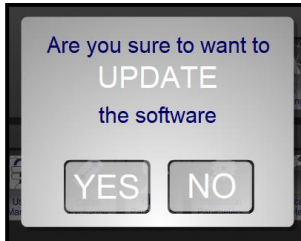

When connecting the USB stick the “UPDATE” request window will appear  
*If no window appears it means that the appliance is already running the same software version as the USB stick.*

Validate the update by pressing “YES” and the software will begin to load.  
*Your appliance may restart one or more times during the update. Depending on the settings of your appliance, one or more updates may be installed. Answer yes to each update request,*

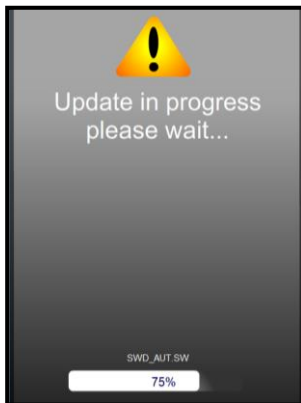

Wait for the update to complete.  
The update is complete when the screen returns to the standard display.

Remove the USB stick from the USB port.

Run the software control procedure to check that the new software has loaded correctly, refer to the previous chapter “Software version control”.

## 4. MAINTENANCE SCREENS

This aid allows you to control the inputs and outputs from the card and peripheral components:

- Screen 1 allows control of the power outputs: Heating elements, contactors, probes...
- Screen 2 allows control of hydraulic outputs: Water solenoids, flow meter.
- Screen 3 allows control of mechanical items: Tank tilt ram, basket tilt ram, sensors...

### 4.1 ACCESS TO THE MAINTENANCE SCREENS

- Select the "SERVICE" menu
- Press the "Technician parameters" tab
- Enter the password: « SAVB »
- Validate "V": When entered if the code is correct access the menu, if not re-enter the PIN code
- Press the "Next" button to scroll on through the different screens

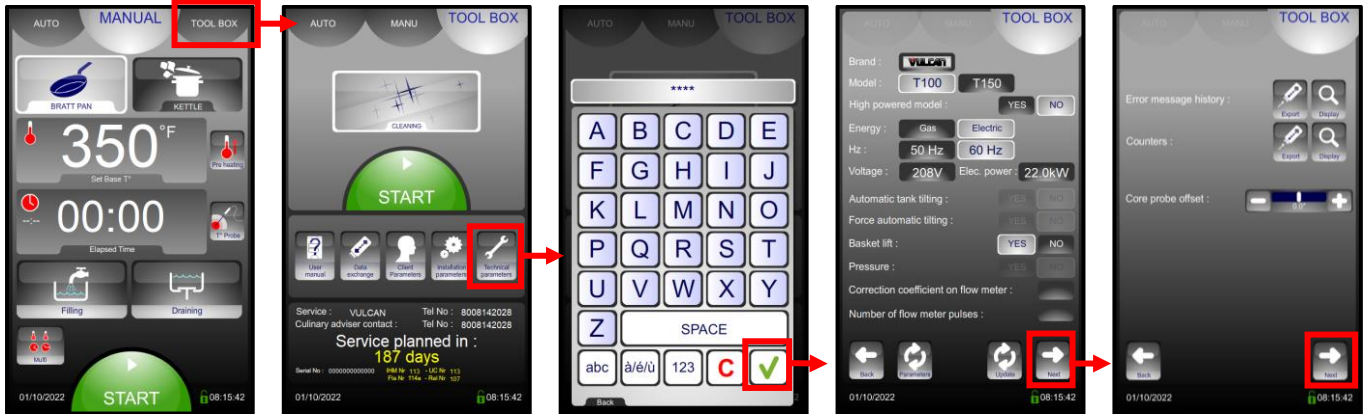

#### 4.1.1 SCREEN: ACTIVATION OF THE POWER OUTPUTS (SCHEMATIC)

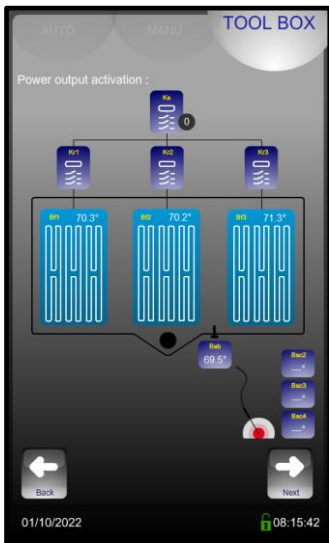

- ➔ Activation of the safety contactor Ks. (One press = 15s)
- ➔ Activation of each individual heating element (One press = 15 seconds of operation)
- ➔ Visualisation of the tank base temperature probes
- ➔ Visualisation of the tank temperature probe
- ➔ Visualisation of the core probe temperature

## 4.1.2 SCREEN: HYDRAULIC CIRCUIT (SCHEMATIC)

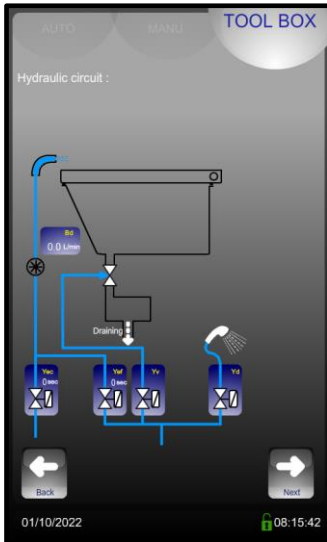

→ Flow meter: visualisation of flow when solenoids are activated

→ Activation of the solenoids: A press on each touch button allows the solenoid to operate (the time of activation is displayed in seconds)  
 Yv and Yd: one press = 10 seconds of operation  
 Yec and Yef: one press = 1 minute of operation

## 4.1.3 SCREEN: TILT AND LIFT

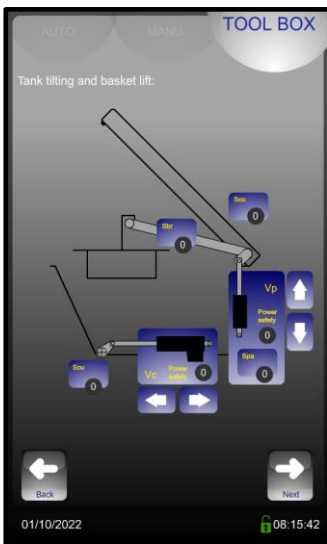

→ Lid opening sensor (1 : lid open ; 0 : lid closed)

→ Basket lift:  
 - lift arm presence detector (1 : yes ; 0 : no)  
 - Basket lift ram: manual ram control and ram status

→ Tank tilt:  
 - Tank base ram detector (1 : tank lowered ; 0 : tank tilted)  
 - Tank tilt ram: manual ram control and ram status  
 Turn the button on the facia to activate the tank tilting jack. (The arrows on the screen are not active for this appliance model)

**5. HYDRAULIC DIAGRAMS**

**5.1 STANDARD VERSION**

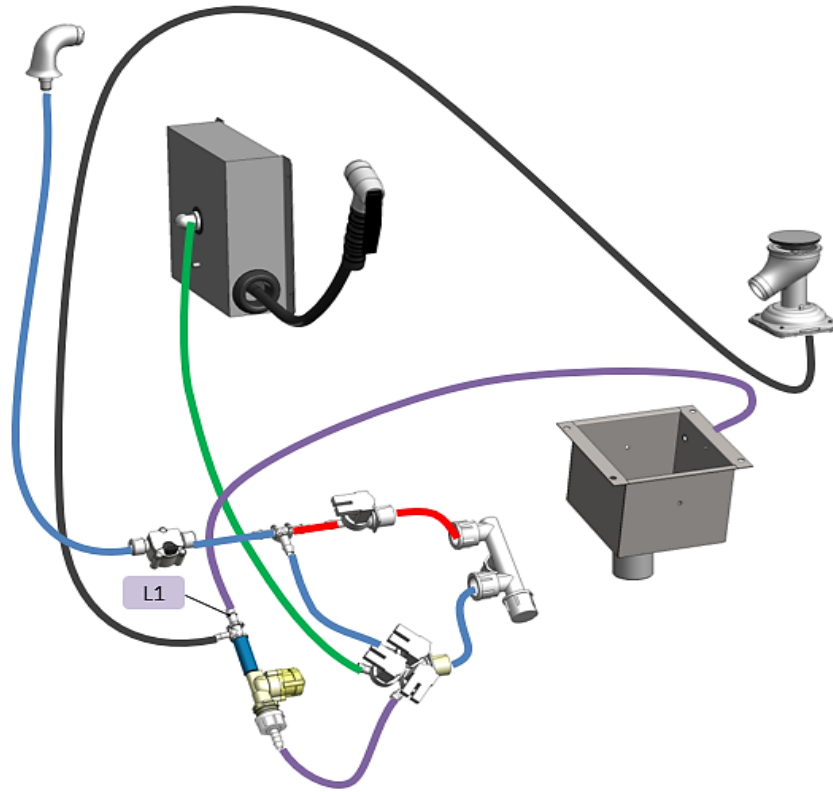

Flow restrictors		100 litres electric	150 litres electric
Drain	L1	0.5 l/min	0.5 l/min



**6. OPERATING FAULTS**

*Client error information: ixx*

*After sales error information: Exx*

**Green screen :**  
Information on the cooking

**Red screen :**  
Cooking stopped (pause)

**Red screen :**  
Cooking stopped (pause)

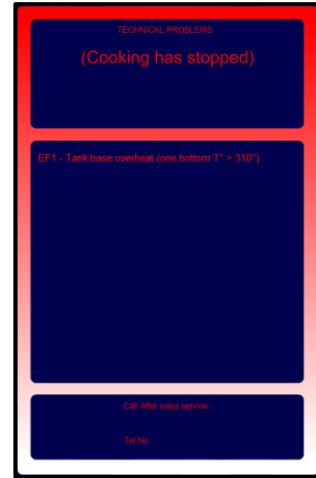
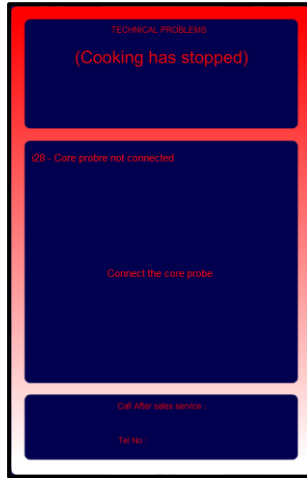
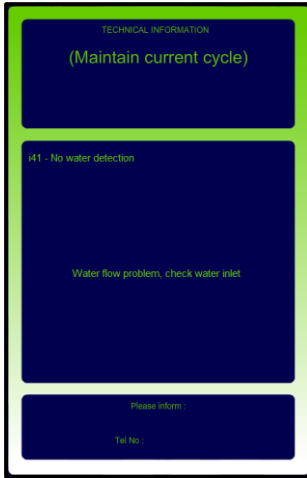

*Non-blocking message  
Touching the screen anywhere will  
clear the message*

*Blocking message  
Cooking stops*

*Blocking message  
Cooking stops*

On screen messages Consequences	Probable causes	What to do?
<b>i28 : Core probe: Faulty or missing</b>		
Cooking doesn't start	Core probe absent at the start of a cooking cycle Core probe faulty	Plug in a functioning probe or switch to timer mode or check the probe connection. Connect the probe and check on the entries screen the values of Bsc2 – Bsc3 and Bsc4. Si "---", Disconnect the connection (Bsc) from the card. Check the PT 100 probe reading (on the connection screws) If the value is incorrect change the probe. If not check the connection or replace the power assembly.
<b>E32 : Core probe: 2 sensors are not working</b>		
Cooking continues	Core probe faulty (More than one sensor working)	Connect the probe and check on the entries screen the values of Bsc2 – Bsc3 and Bsc4. Si "---", Disconnect the connection (Bsc) from the card. Check the PT 100 probe reading (on the connection screws) If the value is incorrect change the probe. If not check the connection or replace the power assembly.
<b>i33 : Core probe : faulty or disconnected during cooking</b>		
Cooking stops	Core probe disconnected during a cooking cycle Core probe faulty	Plug in a functioning probe or switch to timer mode or check the probe connection. Connect the probe and check on the entries screen the values of Bsc2 – Bsc3 and Bsc4. Si "---", Disconnect the connection (Bsc) from the card. Check the PT 100 probe reading on the connection screws. If the value is incorrect change the probe. If not check the connection or replace the power assembly.
<b>E30 : Electronics overheated (&gt; 70°C)</b>		
Cooking continues	Overheating of the technical area because the environment is too hot	Installation problem: check heating appliances near to the right hand side of the unit.
<b>E72 : Electronics overheated (&gt; 85°C)</b>		
Cooking stops	Overheating of the technical area because the environment is too hot	Installation problem: check heating appliances near to the right hand side of the unit.



**VULCAN**

A division of ITW Food Equipment Group LLC  
P.O. Box 696  
Louisville, KY 40201



On screen messages Consequences	Probable causes	What to do?
<b>ESx : Tank base probe short circuit or disconnected (X = Number of the heating zone 1 to 3)</b>		
Cooking stops	Temperature probe poor connection (connection to relay card) or cut	Check the temperature being read by the probe in the entries status (technician's parameters). Check the wires into Bf1, Bf2 or Bf3 are tight (Power assembly).
	Probe short circuit	Check the temperature being read by the probe in the entries status (technician's parameters). Disconnect the connection (Bfx) from the card. Check the PT 100 probe reading on the connection screws. If the value is incorrect change the probe. If the probe is working replace the power assembly. Requires a restart to clear the fault.
<b>ESb : Tank probe short circuit or disconnected</b>		
Cooking stops	Temperature probe poor connection (connection to relay card) or cut	Check the temperature being read by the probe in the entries status (technician's parameters). Check the wires into Bsb are tight (Power assembly).
	Probe short circuit	Check the temperature being read by the probe in the entries status (technician's parameters). Disconnect the connection (Bsb) from the card. Check the PT 100 probe reading on the connection screws. If the value is incorrect change the probe. If the probe is working replace the power assembly. Requires a restart to clear the fault.
<b>EFr : Tank probe overheated</b>		
Cooking stops	The tank probe is measuring a temperature > 205°C	Check that one of the control contactors is not fused or that the corresponding output is not always active (fused relay). <u>To restart the unit:</u> Wait until the temperature is below 120°C Switch off then restart the unit
<b>EFx : Tank base overheated (X = Number of the heating zone 1 to 3)</b>		
Cooking stops.	One of the tank base probes is measuring a temperature > 286°C	Check that one of the control contactors is not fused or that the corresponding output is not always active (fused relay). <u>To restart the unit:</u> Wait until the temperature is below 120°C Switch off then restart the unit
<b>ESA : Tank base probe fault</b>		
Cooking stops.	One of the tank base probes is reading a temperature > 295°C	Check that one of the control contactors is not fused or that the corresponding output is not always active (fused relay). Requires a full restart to clear the fault.
	Temperature probe badly connected (to relay card) or cut	Check the temperature being read by the probe on the entry status (technician's parameters). Check the wires are tight on connectors Bf1, Bf2 or Bf3 (Power assembly).
	Probe short circuited	Check the temperature being read by the probe on the entry status (technician's parameters). Disconnect the connection (Bfx) on the card. Check the value of the PT 100 probe on the connection strip. If the reading is incorrect change the probe. If the probe is correct replace the power assembly. Requires a full restart to clear the fault.
<b>i41 : Lack of water detected, water is not flowing from the spout</b>		
Cooking continues	Water supply turned off	Turn the water on
	The water inlet filter is blocked.	The required water pressure is present at the inlet. The solenoid is correctly supplied. Clean the water inlet filter.
	The coil of one of the solenoids Yef or Yec has failed or is short circuit.	Check solenoid's coil. Change the defective solenoid
	F1 is open.	Change the fuse.
	One of the solenoids coil is cut.	Check that there is power to the solenoid. Check the continuity of the coil with a multi tester. Change the solenoid
	The solenoid control relay is not closing	There is no power between S24 (or S25) on the relay bar and neutral. Change the relay bar.
Flow meter non function	Check the value read by the flow meter in entry status (technician's parameters). Replace if necessary.	

On screen messages Consequences	Probable causes	What to do?
<b>E43 : Leak detected</b>		
Cooking continues	Solenoid failing	Check solenoids Yef (S25) and Yec (S24) and replace if necessary.
	Flow meter non function	Check the value read by the flow meter in entry status (technician's parameters). Replace if necessary.
	Supply relay to one of the solenoids is fused	Check the voltage on the outputs S25 and S24. If power present without water being demanded replace the relay bar on the power assembly.
<b>E90 : Tank tilt ram blocked</b>		
	The power consumption of the ram is > 6 A	An object is trapped under the tank preventing its operation: Clear it out
		Check the tank tilt system
		Check the ram – Replace if necessary
<b>E93 : Safety contactor faulty</b>		
You can't start the cooking cycles.	When the unit is started, the "E1" input on the power assembly is "open".	Check the continuity of the electrical circuit between the auxiliary contact "21 and 22" of Ks and E1 - Tighten the connections - Check the condition of the wires.
		Check the state of Ks – Change if necessary
		Change the power assembly
<b>i49 : USB stick missing or full</b>		
	USB stick not detected or not connected	Plug in a USB stick. If the message persists, change the USB stick
	USB stick full	Empty the USB stick or replace it
<b>i84 : Number of maintenance days at 0</b>		
Risk of damaging the oven	The countdown to the next service has been reached and exceeded	Carry out the planned preventative maintenance operations (see paragraph 7) then reset the counter in the installation parameters (§ 7.3)
<b>i97 : Connectivity error</b>		
Connectivity not working	Identification data incorrect (the data contained in the GATEWAY configuration doesn't match the data on the screen)	If the GATEWAY was previously configured on another oven: follow the GATEWAY configuration procedure and scan the QR code which corresponds to the oven. If the screen has been changed and it is necessary to fill in the appliance's technical data.
<b>i98 : Connectivity error</b>		
No consequence	Connected appliance: technical parameters cannot be changed	The Pop-Up will simply inform the technician why they cannot change the parameters.

**6.1 INSTRUCTIONS IN CASE OF SOFTWARE ANOMOLY**

**6.1.1 SOFTWARE PROBLEM OR SOFTWARE UPDATE FAILURE**

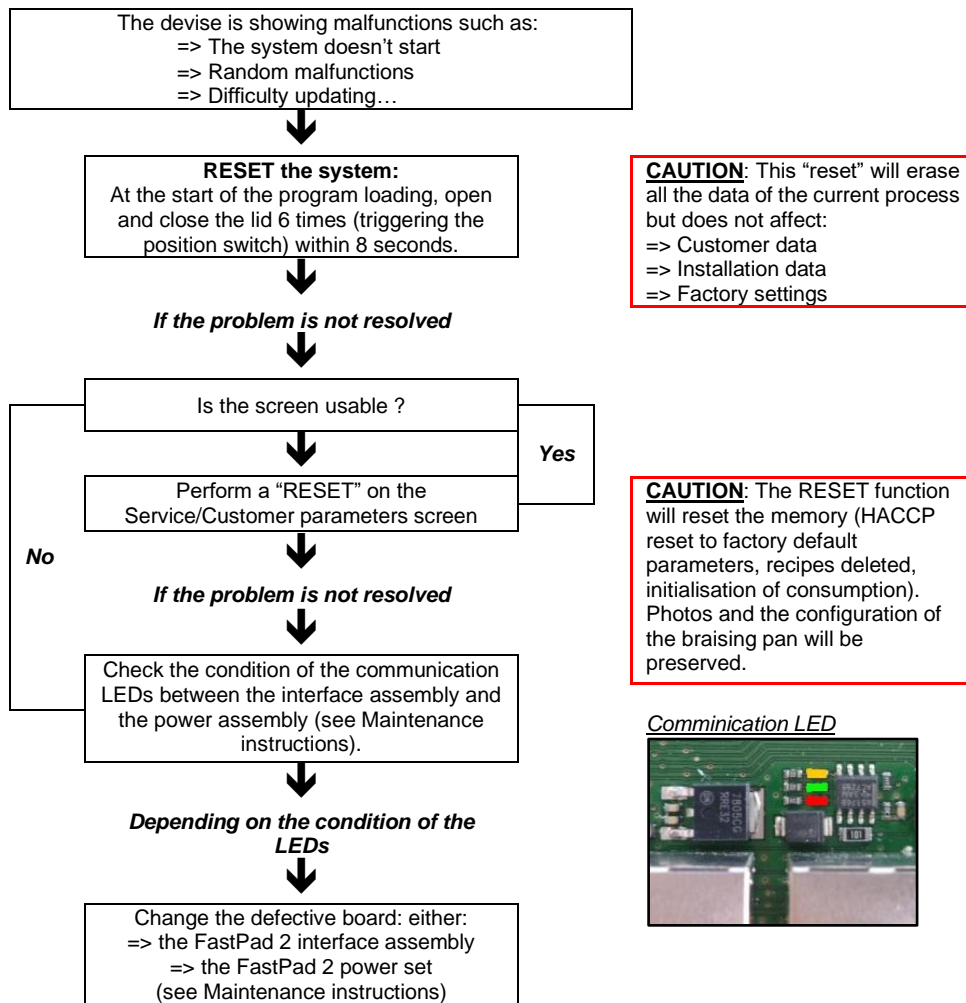

**6.1.2 CONNECTIVITY PROBLEM: DATA ON SMARTCONNECT365.COM ABSENT**

The client is no longer receiving data from smartconnect356.com: check the technician's "ITW COOKING APP" for the possible causes in "Connection states" (Application downloadable from WebAstech)

- ⇒ **Connection to the client's network "Disconnected":**  
 Ensure that the line to the customer's "box" is operational; check that the passwords, SSID have not changed.
  - If the Gateway is connected via WiFi, make sure the signal strength is good (The intensity received by the module should be between -30dBm and -67dBm, Below this level [-70dBm and under] the WiFi connection is not reliable).
  - If the Gateway is connected via ethernet, Ensure that there are no interruptions on the wire link between the appliance and the client's "box".
- ⇒ **Cloud connection "Disconnected" :**  
 The issue lies between the customer's "box" and the internet. Refer to the customer's network administrator.
- ⇒ **Connection to the equipment "Disconnected" :**  
 Check that the "orange" and "green" communication LEDs are flashing:



- If not :
- Check that the cable connecting the module to the appliance is fully inserted.
  - Switch the appliance off and on again at the power supply.



**VULCAN**  
 A division of ITW Food Equipment Group LLC  
 P.O. Box 696  
 Louisville, KY 40201

## 7. PREVENTIVE MAINTENANCE

To ensure the proper, long-lasting and safe functioning of the equipment, it should be serviced by qualified personnel from our company.

The customer will be automatically informed when service is needed. The service counter is a calculated function of the frequency of use and of the number of hours between 2 services. These values must be entered by the technician when installing the appliance and must be verified after every maintenance operation.

### 7.1 LIST OF ACTIONS

**Caution:** The appliance must be isolated electrically during cleaning or maintenance and when replacing parts.

Subject	Recommendations (Every year Or every 1500 h)
Electrical safety	Check the earth continuity and equipotential connections
Installation	Fixing and alignment of units, State of supply cables
Doors and lids	Condition of hinges, alignment, lubricate and adjust if necessary
Tanks (depending on model)	State of the tank - Absence of lime scale and traces of corrosion - Check the valve seals and drain outlet - Change seals if necessary
Facia labels	Cleaning; No deterioration; no cracks or perforations; Change if necessary
Technical compartments	Clean the technical compartments; If any drips are found, find the origin and rectify.
Insulation / heat protection in technical compartments	Visual control - Correct if degraded
Technical compartment ventilation	Clean all air inlets and outlets - Change the filters if there are any - Check the fans function tank and clean the blades.
General water tightness of hydraulic circuits	Visual control - Tap functioning properly
Solenoids	No indication of the coils overheating (colour changed) - Check they work - Clean the filters.
All power connections (Incoming power terminals, terminals on commutators, contactors and thermostats)	Visual control; Retighten contacts; Detect any overheating and correct if necessary
Operating	Check the incoming power and the current used by the heating elements. Tighten the heating elements connections if necessary (see section below)
Tank	Check the levelling, the adjustment and operation of the end stop switches
Drain outlet	Check the state of the seal – Change if necessary
Lid	Check the adjustment of the lid adjustment springs. Check the operation of the end stop switches
Electronic cards	General dust removal - No traces of leaks or moisture inside the technical compartment - No oxidation on the connectors
Coder	No traces of leaks or oxidation - Check that it is working properly
Hydraulic compartment	No leakage - No oxidation on the flow meter contacts - If necessary, tighten the hydraulic clamps and clean the electrical contacts
Core probe	General state (point, cable) – Clean the plug base

### 7.2 ADJUSTING FREQUENCY INTERVENTION MAINTENANCE, USAGE RATE PER DAY

**REMINDER :** The frequency between two maintenance visits and the rate of use per day have been entered according to information (number of hours per day/type of cooking) provided by the customer during installation.

During maintenance it is the responsibility of the technician to check these settings against the actual use of the appliance and modify them if necessary (according to the table below) :

Type of use (Client information)		Hours of use/day (Customer information)		Adjusting the installation parameters (To be entered in Installation Parameters)	
				Maintenance regularity (in hours)	Hours per day (in hours)
<b>NORMAL USE</b>		LIGHT	< 5 h	<b>1500</b>	<b>5</b>
		STANDARD	5-10 h	<b>2000</b>	<b>10</b>
		INTENSIVE	10-15 h	<b>2500</b>	<b>15</b>
		VERY INTENSIVE	15-24 h	<b>3000</b>	<b>24</b>

**Procedure :**

- Go into the service screen
- Press the "installation parameter" button
- Enter the PIN code for the installer "INSB"
- Validate "V": when all the code has been entered and it is correct access the menu or start on the PIN number again.



**VULCAN**

A division of ITW Food Equipment Group LLC  
P.O. Box 696  
Louisville, KY 40201



- Enter the number of hours before the next service visit: « HSR ». Adjustable from 100 to 5000 hours. Allow at least one service per year.
  - \* Select the value to be modified
  - \* Adjust the value using the coder
- Enter the average hours per day that the unit is likely to operate: « H-d ». Adjustable from 1 to 24 hours.
  - \* Select the value to be modified
  - \* Adjust the value using the coder

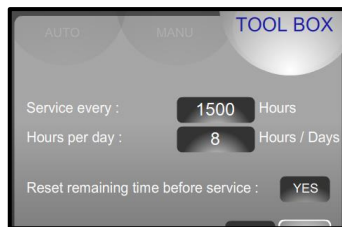

- ➔ Frequency of maintenance
- ➔ Level of use per day

### 7.3 RE-INITIALISATION OF THE MAINTENANCE COUNTER

- Go into the service screen
- Press the “installation parameter” button
- Enter the PIN code for the installer “INSB”
- Validate “V”: when all the code has been entered and it is correct access the menu or start on the PIN number again.
- Re-initialise the remaining time before the next service.

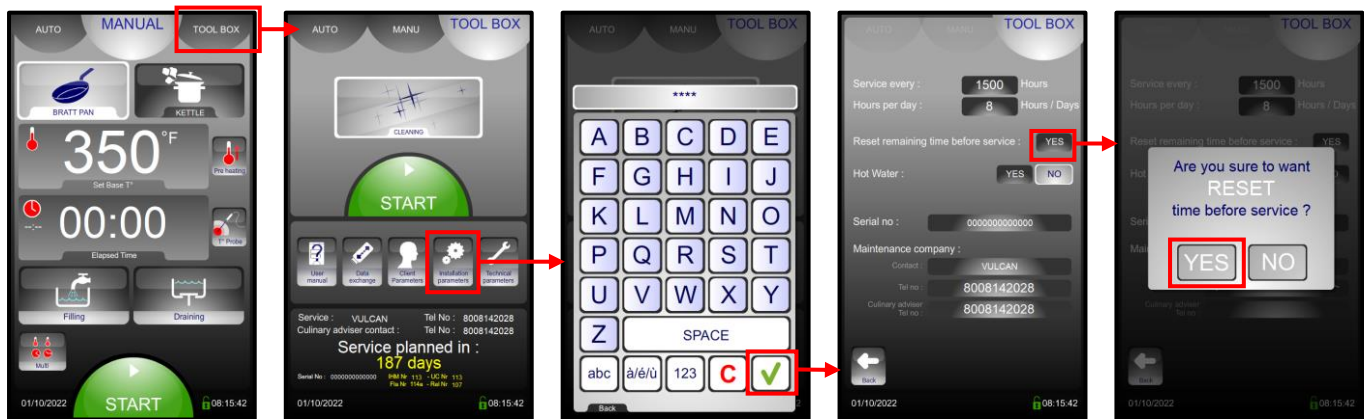

Note: If the time remaining before the next maintenance is less than or equal to 0, error code i84 will be displayed in error codes

### 7.4 CONNECTING THE TERMINALS TO THE HEATING ELEMENTS

- The terminals on the heating elements must be fitted with two brass washers, a serrated washer and a brass nut, as shown in the diagram below
- To tighten, use a flat spanner as a counter-key on the hexagonal part of the heating element connection and tighten the brass nut with a torque screwdriver to 4 N m



**VULCAN**  
 A division of ITW Food Equipment Group LLC  
 P.O. Box 696  
 Louisville, KY 40201

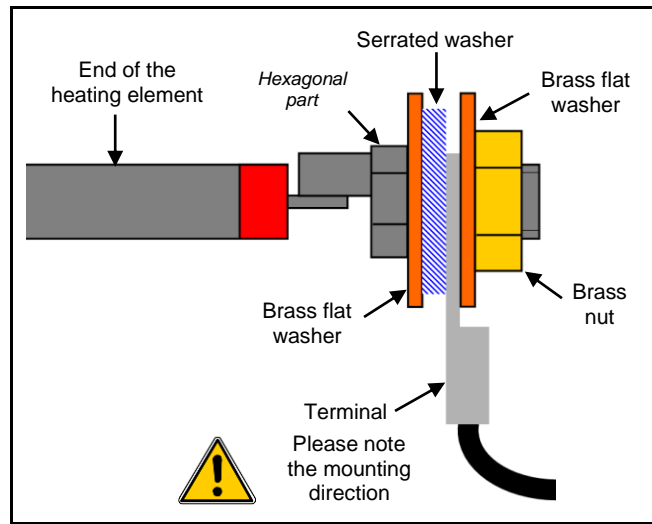



## 8. PROCEDURES FOR CHANGING COMPONENTS

### 8.1 LOCATION OF THE TECHNICAL COMPONENTS

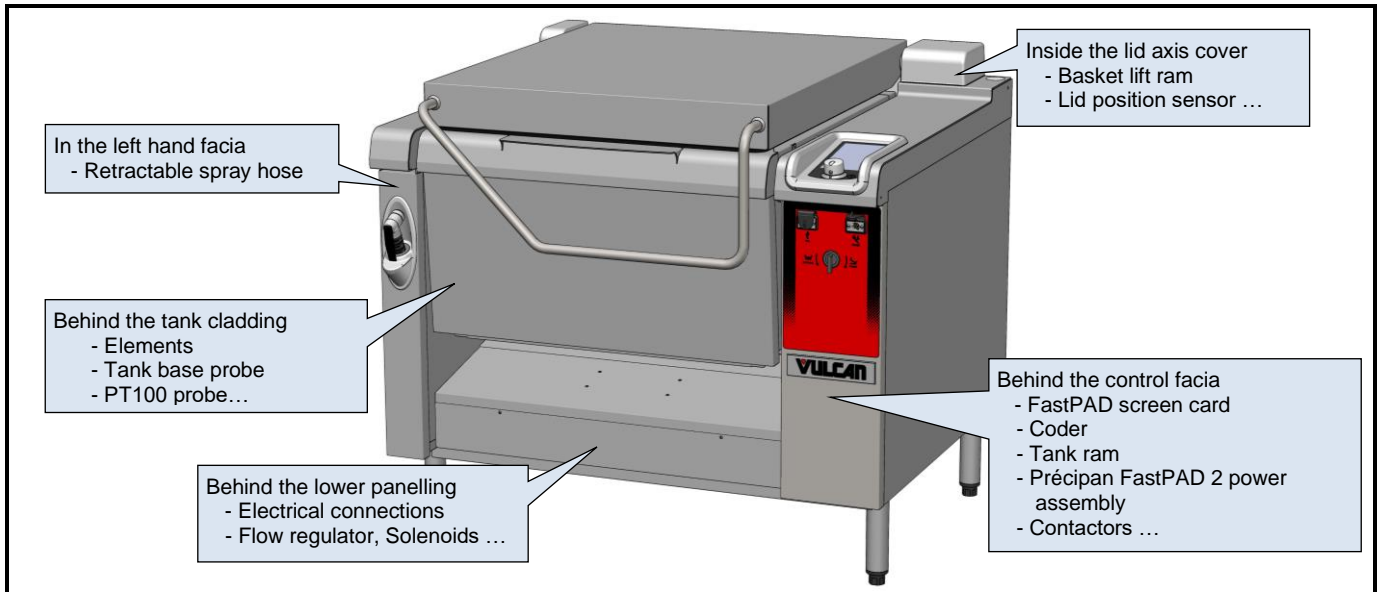

**WARNING:** The unit must be disconnected electrically during maintenance work and whilst replacing parts.

### 8.2 ACCESS TO COMPONENTS

#### 8.2.1 BEHIND THE CONTROL FACIA

- Removing the control facia
  - Undo the two HM5 x16 screws under the facia
  - Open it: Pull gently downwards then towards you
  - Place the facia next to the unit to avoid having to disconnect the power socket and the connections for the USB and core probe
- Access to the electrical board
  - Pull the electrical drawer towards you
  - Be careful with the cables when pulling the board out.*

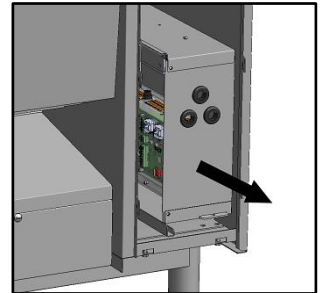
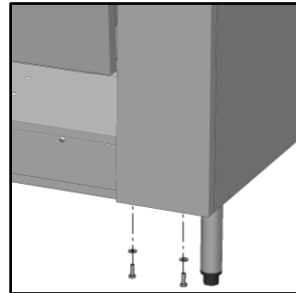

#### 8.2.2 BEHIND THE LOWER PANELLING

- Removing the lower panelling
  - Undo the two M5 x16 pan-head screws
  - Remove the panel
    - Lift slightly then towards you

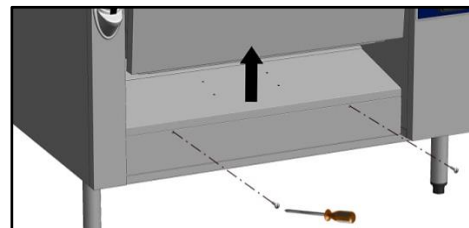

#### 8.2.3 BEHIND THE TANK CLADDING

- Removing the tank cladding
  - Undo the three M5 x16 pan-head screws under the front edge of the tank
  - Undo the two HM5 x16 screws under the cladding
  - Remove the cladding
    - Tilt the facia by pulling the bottom towards you then disengage at the top

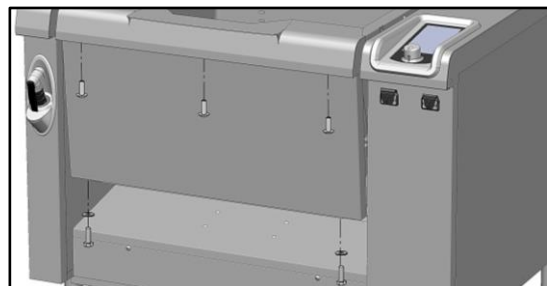

**VULCAN**

A division of ITW Food Equipment Group LLC  
P.O. Box 696  
Louisville, KY 40201

### 8.3 CODER

- Removing the control facia
  - See the section on accessing components «Behind the control facia»
- Remove the coder button
  - Remove the screw cover plug
  - Unscrew and remove the HCM4 x12 screw
  - Pull the button off
- Removing the coder
  - Undo the coder fixing nut (12mm spanner)
  - Disconnect the coder from the screen card
  - Remove the coder and change it

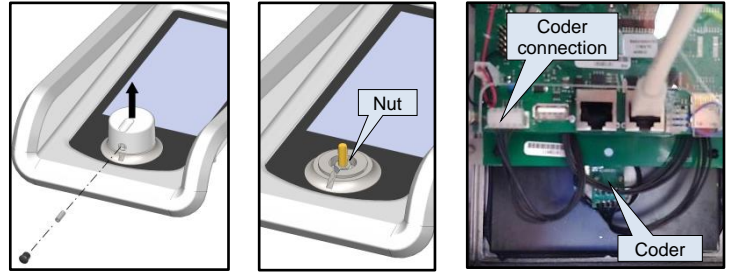

### 8.4 PRECIPAN FASTPAD 2 INTERFACE (SCREEN CARD)

- Remove the control facia
  - See the section on accessing components «Behind the control facia»
- Disconnect from the screen card sub assembly:
  - The USB connection
  - The RJ45 cable between the screen and relay cards

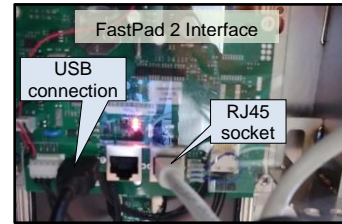

- Removing the Précipan FASTPAD 2 interface
  - Undo the 2 blind fixing nuts

*Attention: When removing the 2 nuts do not lose the 2 springs holding the card up under the glass support*

  - Remove the screen card

*Note: Before refitting the screen card sub assembly onto its support ensure that the inside of the facia and screen glasses are clean (Clean away dust, finger prints...).*

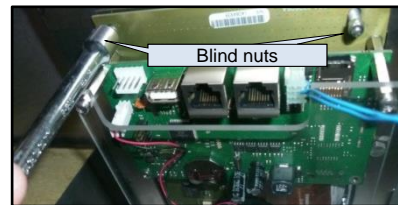

*Note: Do not forget to remove the protective film from the new cards screen*

- Remove the stop/start shunt connection to reconnect it to the new sub assembly
- Change the screen card sub assembly

#### Refitting the screen card sub assembly

- *Ensure that the inside of the facia and screen glasses are clean (Clean away dust, finger prints...).*
- *Take the screen card sub assembly and position it on the 2 black rubber coated studs and insert it into the 2 pins*
- *Re-fix the sub assembly using the 2 blind nuts. Do not forget to refit the plate holding springs*

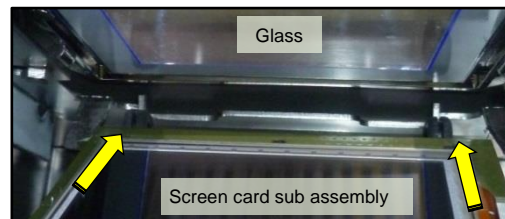
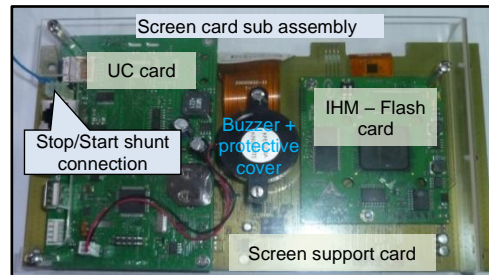

#### 8.4.1 BUZZER ASSEMBLE + PROTECTIVE COVER

Place the Screen card sub assembly on a smooth clean surface to avoid scratching the glass

- Undo the 3 fixing screws holding the plastic cover onto the screen card sub assembly
  - Lift the cover off
  - Disconnect the Buzzer from the UC card
  - Change the Buzzer + protective cover assembly
- When refitting the buzzer onto the cover do not fully tighten the fixing nuts to allow the optimum function of the buzzer it should be mounted 'floating'*

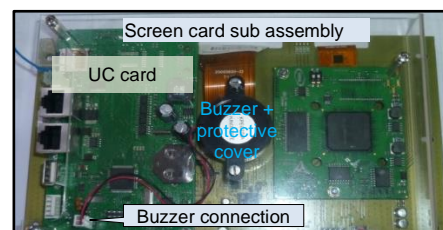



## 8.5 SCREEN SUPPORT

- Remove the control fascia
  - See the section on accessing components «Behind the control fascia»
- Disconnect the screen card sub assembly :
  - The USB connection
  - The RJ45 cable between the screen and relay cards

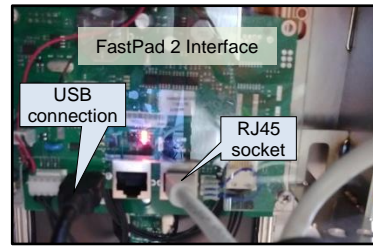

- Removing the screen support sub assembly + Précipan FASTPAD 2 interface
  - Undo the 7 fixing screws holding the screen support to the top of the unit
  - Remove the screen support: Slide it slightly towards you then lift towards the front.
  - Remove the seal between the screen support and the top of the unit.

*We recommend that the seal is changed as a matter of course when removing or replacing the screen support*

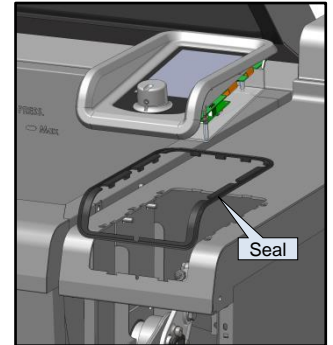
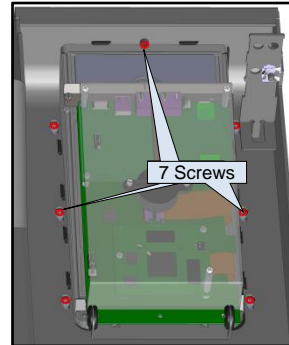

- Removing the Précipan FASTPAD 2 interface
  - See the section on « Précipan FastPAD 2 interface »
- Change the screen support
 

*Note: Before refitting the screen card sub assembly onto its support, ensure that the inside of the fascia and screen glasses are clean (Clean away dust, finger prints...).*

*Note: Don't forget to refit the seal*

## 8.6 PRECIPAN FASTPAD 2 POWER CARD (complete, with its enclosure)

To access the motor fuses,.. except for the solenoid triac, removing the FastPAD 2 power card is not necessary.

- Access to the Precipan FastPAD 2 power card
  - See the section on accessing components «Behind the control fascia»
- Removing the faulty Precipan FastPAD 2 power card box
  - Disconnect:
    - ◆ The 3 output connections
    - ◆ Probe(s) connection
    - ◆ Flow regulator connection
    - ◆ Core probe socket connection
    - ◆ RJ45 connection
    - ◆ Supply connection
    - ◆ Tank ram connection
    - ◆ Connection to the optional basket lift

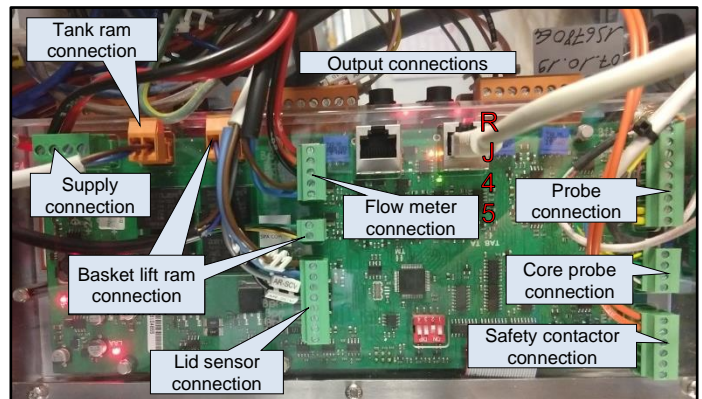

- Undo the M4 TORX screws on the side of the box slightly
- Shift the Power assembly box forward and pull it upwards

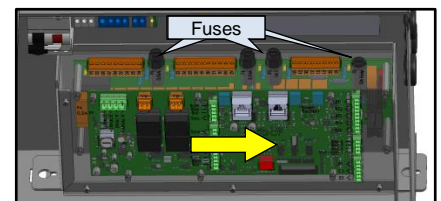
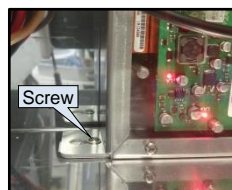

### 8.6.1 FASTPAD 2 MAXI UL RELAY BAR

- Removing the complete power assembly box
  - See the section on «Précipan FastPAD 2 power card»
- Undo the 4 cross-head screws from the transparent protective housing
- Remove the assembly of cards from the aluminium support
- Place the box on a table (transparent cover side down)



- Removing the FastPAD 2 maxi UL relay bar
  - Undo the 4 cross-head screws from the posts
  - Place the card nearby
  - Disconnect communication cable strip from the other card
- Change the FastPAD 2 maxi UL relay bar

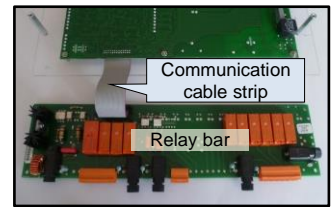
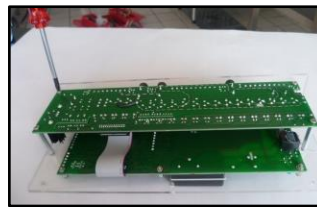

**8.7 FLOW REGULATOR**

- Remove the lower fascia panel
  - See the section on accessing components «Behind the lower fascia»
- Disconnect the electrical supply to the flow regulator
- Removing the flow regulator
  - Removing the flow regulator
    - ◆ Undo the two fixing screws under the unit slightly
    - ◆ Remove the flow regulator by pushing gently towards the rear then lift upwards
  - Hydraulic disconnection
    - ◆ Undo the 2 flexibles to the flow regulator
- Change the flow regulator
- Control procedure for the flow regulator
  - Define a fill setting (for example: 5 litres)
  - Collect the water that flows in a container
  - Measure the actual volume of water.
  - Check if the volume corresponds to the set volume
  - In the event that the two are not the same modify the coefficient value of the flow regulator. It is set to 0.86 by default.
    - ◆ Calculate a new coefficient  
 New coefficient = actual coefficient x the flow regulator value or set value / volume of water actually measured
  - Enter this value in the service menu (see paragraph « Bratt pan parameter setting »)

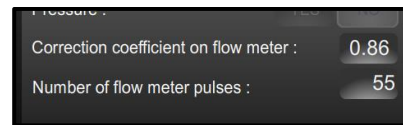
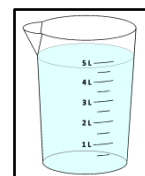
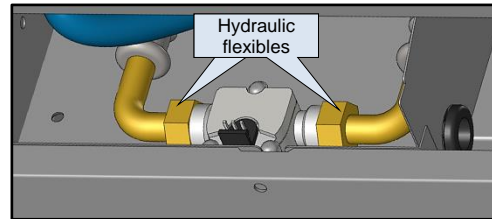
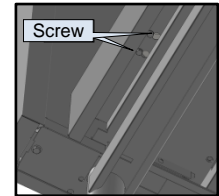
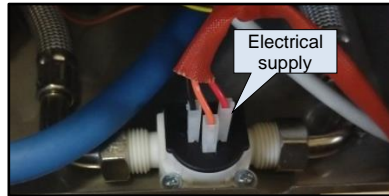

**8.8 LID SWITCH**

- Open the lid
- Remove the right hand lid axis cover
  - Undo the screw and remove the cover
- Disconnect the electrical supply to the switch
  - Disconnect the wires from the terminal block
- Removing the switch
  - Undo the two fixing screws
  - Remove the switch
- Change the switch
- Adjusting the lid opening
  - Adjust the position of the switch on the lid axis to ensure the lid is detected when opened to 80cms and prevent the risk of impact between the lid and the tank

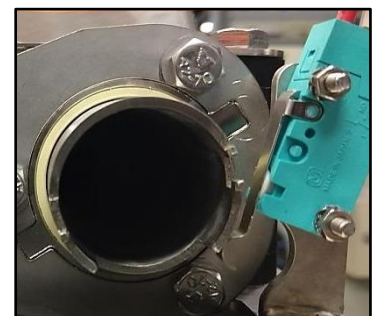
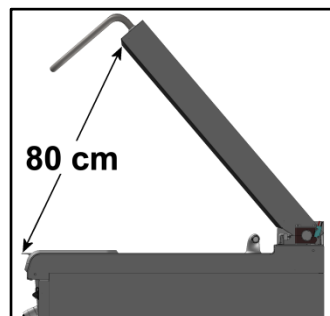
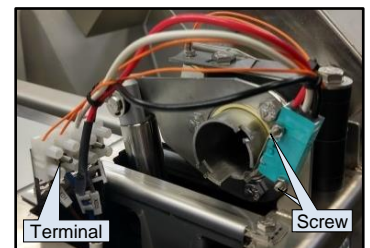
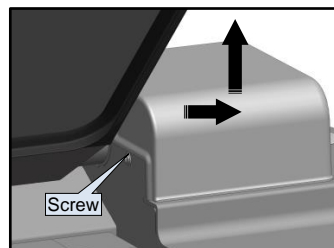

## 8.9 TANK RAM

- Remove the control facia
  - See the section on accessing components «Behind the control facia»
- Disconnect the electrical supply to the ram
  - Disconnect the connections to the Precipan FastPAD 2 power card
- Disconnect the electrical supply to the micro-switch
  - Disconnect the two push connections
- Removing the tank ram
  - Undo the 2 screws + the nut at the front of the ram
  - Unscrew the fixing screw at the back of the ram
  - Remove the axis
  - Remove the circlips and the pin at the front of the ram
  - Remove the ram
- Removing the micro-switch
  - Unscrew the 2 screws holding the micro-switch and remove it
- Change the ram
- Fit the switch and its support onto the new ram
  - Fully extend the rod-arm of the new ram
  - Fit the support + micro-switch onto the plastic part of the extended arm
  - Retract the ram rod-arm as far as possible. The stainless part of the rod and the second part (plastic) will retract, the switch will locate itself.

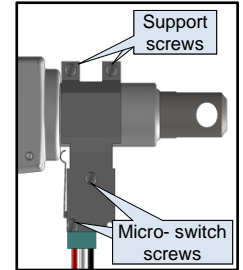
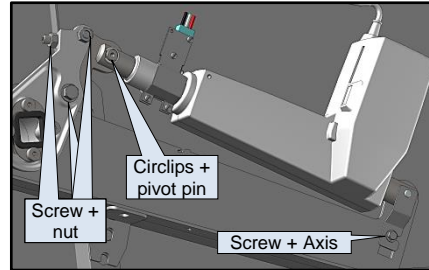
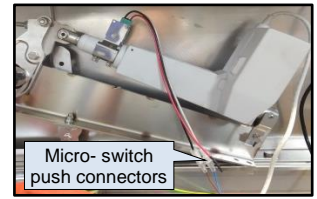
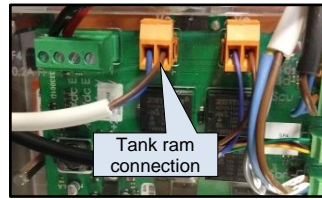

## 8.10 BASKET LIFT RAM

- Open the lid
- Remove the control facia
  - See the section on accessing components «Behind the control facia»
- Remove the right hand lid axis cover
  - Undo the screw and remove the cover
- Disconnect the electrical supply to the ram
  - Disconnect the connections to the Precipan FastPAD 2 power card
- Take the terminal support off
  - Undo the two fixing bolts and move the support towards the rear
- Removing the ram support
  - Remove the circlips and the front retaining pin from the ram. Pull the pin to the left
  - Undo the 2 ram support fixing
  - Remove the ram support upwards
- Removing the ram
  - Remove the circlips and the rear retaining pin from the ram
  - Lift the ram off
- Change the ram

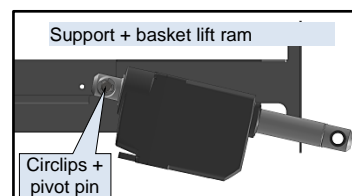
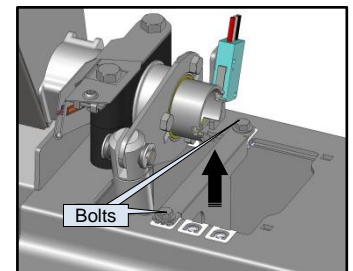
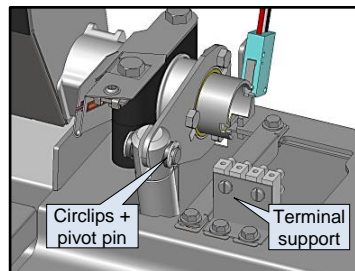
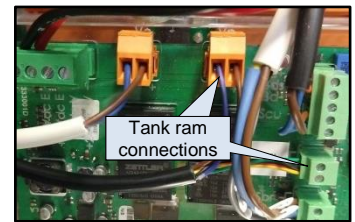
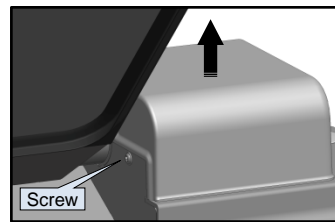

## 9. CHECKING THE TEMPERATURE SENSORS

### 9.1 PT100 PROBE

#### PT100 probe components

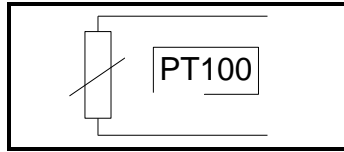

Temperature sensor comprises a resistance sensor with the value of 100 ohms for a temperature of 0° and 138.5 ohms for a temperature of 100°C. The variation of the resistance to temperature relationship is linear. The resistance reading is directly proportional to the measured temperature. The sensor is not polarised. The sensor can be extended using copper wire.

Temperature in °C relative to Resistance in Ω for PT100 sensor										
°C	0	1	2	3	4	5	6	7	8	9
0	100.00	100.39	100.78	101.17	101.56	101.95	102.34	102.73	103.12	103.51
10	103.90	104.29	104.68	105.07	105.46	105.85	106.24	106.63	107.02	107.4
20	107.79	108.18	108.57	108.96	109.35	109.73	110.12	110.51	110.90	111.28
30	111.67	112.06	112.45	112.83	113.22	113.61	113.99	114.38	114.77	115.15
40	115.54	115.93	116.31	116.70	117.08	117.47	117.85	118.24	118.62	119.01
50	119.40	119.78	120.16	120.55	120.93	121.32	121.70	122.09	122.47	122.86
60	123.24	123.62	124.01	124.39	124.77	125.16	125.54	125.92	126.31	126.69
70	127.07	127.45	127.84	128.22	128.60	128.98	129.37	129.75	130.13	130.51
80	130.89	131.27	131.66	132.04	132.42	132.80	133.18	133.56	133.94	134.32
90	134.70	135.08	135.46	135.84	136.22	136.60	136.98	137.36	137.74	138.12
100	138.50	138.88	139.26	139.64	140.02	140.39	140.77	141.15	141.53	141.91
110	142.29	142.66	143.04	143.42	143.80	144.17	144.55	144.93	145.31	145.68
120	146.06	146.44	146.81	147.19	147.57	147.94	148.32	148.70	149.07	149.45
130	149.82	150.20	150.57	150.95	151.33	151.70	152.08	152.45	152.83	153.20
140	153.58	153.95	154.32	154.70	155.07	155.45	155.82	156.19	156.57	156.94
150	157.31	157.69	158.06	158.43	158.81	159.18	159.55	159.93	160.30	160.67
160	161.04	161.42	161.79	162.16	162.53	162.90	163.27	163.65	164.02	164.39
170	164.76	165.13	165.50	165.87	166.24	166.61	166.98	167.35	167.72	168.09
180	168.46	168.83	169.20	169.57	169.94	170.31	170.68	171.05	171.42	171.79
190	172.16	172.53	172.90	173.26	173.63	174.00	174.37	174.74	175.10	175.47
200	175.84	176.21	176.57	176.94	177.31	177.68	178.04	178.41	178.78	179.14
210	179.51	179.88	180.24	180.61	180.97	181.34	181.71	182.07	182.44	182.80
220	183.17	183.53	183.90	184.26	184.63	184.99	185.36	185.72	186.09	186.45

#### How to read the chart:

To find the resistance corresponding to a temperature of 164°C.

- Find the intersection of the line 160°C and the column 4°C.
- The reading shows 162.53 Ohms.

#### Check

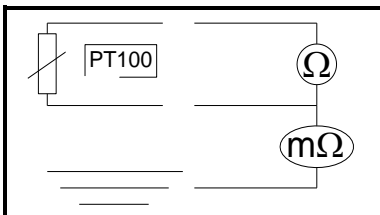

Check sensor resistance with an ohmmeter set to 200 ohms (less than 107 ohms for 20°).

Check the sensor insulation between one of the leads and the metal part with the ohmmeter set at 20 mega ohms (a value over 15 mega ohms).

Check the continuity between the feed and the metal part of the sensor.



## 10. ADJUSTMENT TANK / LID

### 10.1 LEVELLING THE TANK / CHASSIS

Before doing anything to the tank check that the chassis is level.

- If it isn't:
  - Undertake the levelling following the procedures found in the installation manual (section: 'Locating') depending on the type of unit installed
  - If there is still a problem after the chassis has been levelled follow the procedure for 'Adjusting the tank' that follows:
- If the chassis is level: (as per the advice in the installation manual)
  - Follow the procedure for 'Adjusting the tank' that follows:

#### Adjusting the tank:

- Open the cover
  - Remove the tanks front panels and the fascia of the right hand arm
  - Release the tank:
    - Slacken (without removing) the 2 bolts on the ram connecting it to the adjustment arm
    - Slacken the lock nut on the adjustment screw and undo it a few turns
    - Slacken (without removing) the four screws holding the tank to its axis (at each end):
- In the following order:
- Tank lowered: the lower front screw
  - Tank tilted: the 2 upper screws (front and rear) and the lower rear screw

Ram + connecting arm screws

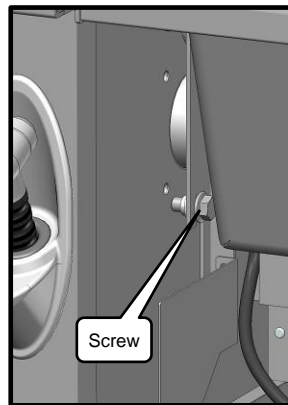
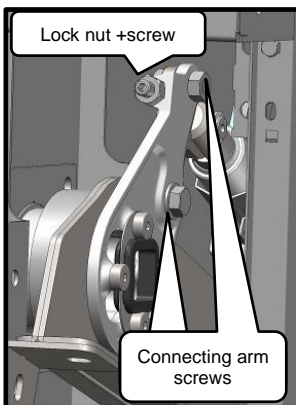

Screws holding the tank to its axis

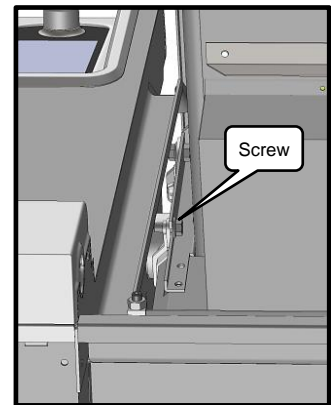
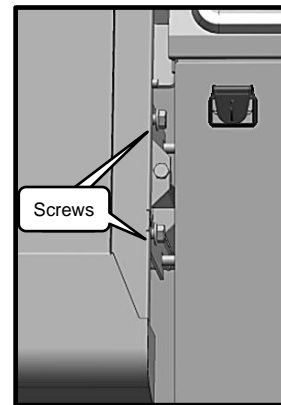

- Levelling the tank within the chassis:
    - Tilt the tank into its lowered position and check the alignment within the chassis:
      - Rear alignment: Place a spirit level on the rear of the tank
      - If it is not in alignment:
        - Measure the gap between the tank and the chassis
        - Tilt the tank, slacken the lock nuts (one each side) and adjust by tightening /slackening the tank stop screw. (1 turn = 1.5 mm in height)
- Continue with this procedure until the tank alignment is correct. Do not forget to retighten the lock nuts afterwards.

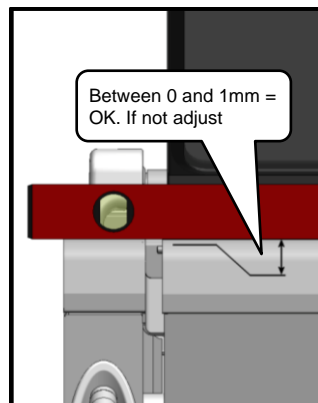
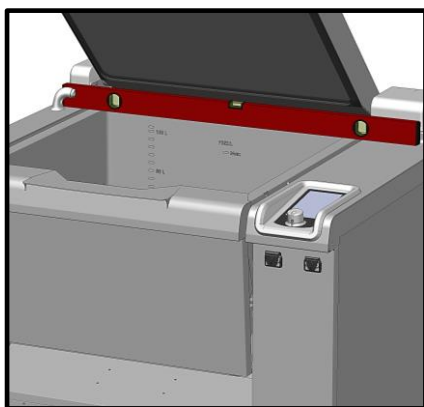

- Once the tank is aligned:
  - Move on to the following:

Front alignment: Place a spirit level over the tank axis

→ If it isn't aligned:

- Measure the gap between the tank and the chassis

Tilt the tank, slacken the lock nuts (one each side) and adjust by tightening /slackening the tank stop screw.  
(1 turn = 1.25 mm in height)

Continue with this procedure until the tank alignment is correct

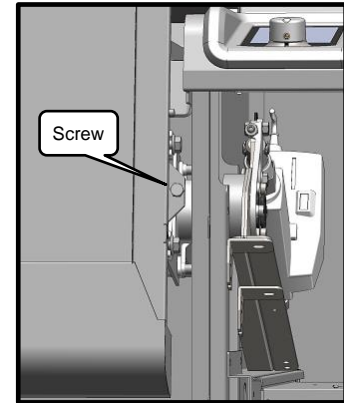
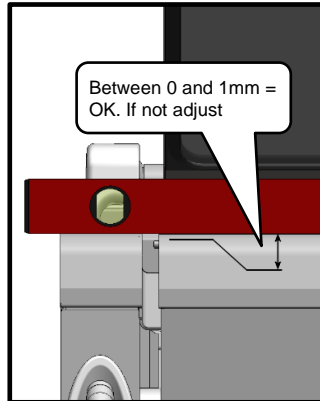
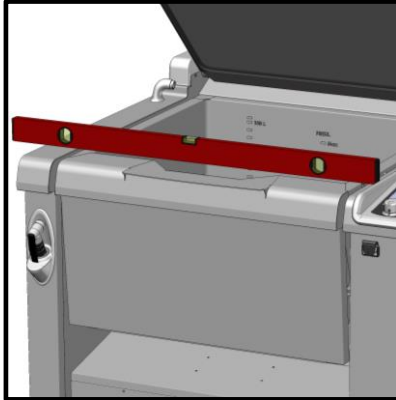

→ Once the tank is aligned (distance between the tank and the chassis less than 1mm):

- Move on to the following:

- Clamp the tank in place:

- Tighten the four screws holding the tank to its axis (at each end):
- Tighten the ram adjustment screw and its lock nut
- Tighten the 2 screws on the ram adjustment arm

## 10.2 ADJUSTING THE LIDS COUNTERBALANCE

This adjustment allows you to increase or reduce the effort required to open or close the lid.

- Open the lid
  - Remove the two covers protection the lid articulation
  - Remove the fascia from the left hand arm
  - Ensure the bearings on each side of the lid are tight:
    - Check and tighten the two screws to a torque of 10N.m
    - Adjust the spring tension by tightening (tensions the spring) or slackening (releases the spring) the threaded adjustment rod:
- Adjustment is correct when:
- the cover remains open when it is **at 40cm** above the tank
  - and closes properly onto the tank (lid seal resting on the front of the tank)

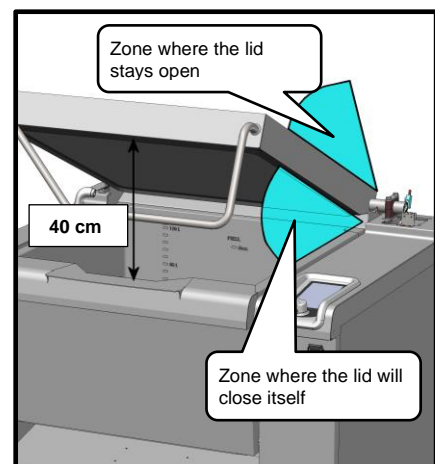
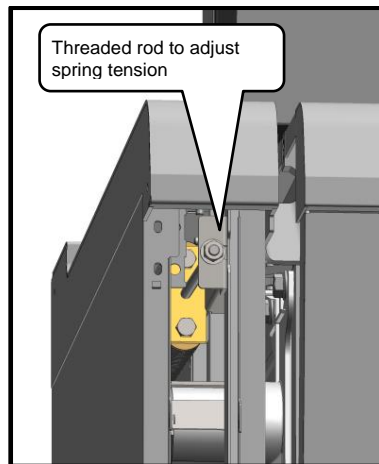
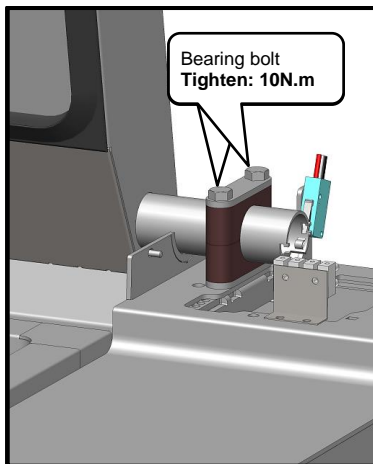

*Note: be careful not to overtighten the springs, which would result in a complete cover closure at the front..*

**Attention:** Do not adjust the tension unless the lid is fully open

## 11. RECOMMENDED (WEAR) AND FRONT LINE SPARE PARTS

Designation	Codes
FastPAD 2 Precipan interface assembly	156817
Electric ram after sales kit LA31 6000N 24V	156823
Electric ram after sales kit (ram + cable) LA23 2500N 24V	156824
Single solenoid 1 x 15 litres/min UL	156864
3-way solenoid 3 x 15 litres/min UL	156865
Reed switch	300676
230 V lever microswitch	300678
Three-pole 25A 230V 50/60 Hz contactor	300697
Three-pole 32A 230V 50/60 Hz contactor	300698
Three-pole 40A 230V 50/60 Hz contactor	300699
Three-pole 50A 230V 50/60 Hz contactor	300700
Tree-pole 80A 230V 50/60 HZ contactor	300702
Anti-interference relay	300769
Ultra-fast fuse 0.2A 250V 5 x 20	300787
5 x 20 fast fuse 1amp	300789
Contactor LC1D80P7	300798
Block RC LA4DA2U	300799
Glass fuse 4A	300801
Snap Action Switching	300804
Manual resetting 320°C thermostat + nut	301066
Encapsulated PT100 probe	301504
Well base probe	301506
Armoured 4650-Watt element – 208V	302278
Armoured 4650-Watt element - 277V/240V	302294
Axial fan	304297
lever microswitch	306913
Fuse 5x20 4A FSF	306963
Switching power supply	308351
415 VA Transformer	308499
Fuse 3.15 Amps	309407
Inter card cable (2 metres long)	309614
Coder	309632
FastPAD 2 Screen	309646
FastPAD 2 Max UL relay connection	309663
FastPAD 2 Precipan power card UL	309712
Flow meter 100 G1/2	314388
Retractable spray hose kit	316187
Transparent silicone tube	366068
Outlet seal	366657
Lid seal with cut-out - 100L	366675
Lid seal with cut-out – 150L	366676
Anti-parasite module	407002



**VULCAN**

A division of ITW Food Equipment Group LLC  
P.O. Box 696  
Louisville, KY 40201