

winco®

COMMERCIAL ELECTRIC RICE COOKER

Operating Instruction Manual



RC-P301



For California Customers

WARNING: Cancer and Reproductive Harm - www.P65Warnings.ca.gov

Model	Voltage	Power	Amperage	Plug Type	Overall Dimensions			Product Weight
					Length	Depth	Height	
RC-P301	120V ~ 60Hz	1550W	13A	NEMA 5-15P	19-7/8" (505mm)	17-1/2" (445mm)	13-3/8" (340mm)	15 lbs 6.8 kgs

BEFORE OPERATING ANY EQUIPMENT, READ AND FAMILIARIZE YOURSELF WITH THESE USE AND SAFETY INSTRUCTIONS

Congratulations on your purchase of this WINCO® commercial equipment. WINCO takes pride in the quality of its products. When used as intended, and with proper care and maintenance, you will experience years of reliable operation from this equipment. To ensure best results, it is important that you read and follow the instructions in this manual carefully. **It's important to save these instructions for future reference.**

Commercial Electric Rice Cooker

Important For Future Reference

Please complete this information and retain this manual for the life of the equipment. For Warranty Service and/or parts, this information is required.

Model Number

Serial Number

Date Purchased



WARNING: IMPROPER INSTALLATION, ADJUSTMENT, ALTERATION, SERVICE OR MAINTENANCE CAN CAUSE PROPERTY DAMAGE, INJURY, OR DEATH. READ THE INSTALLATION, OPERATION, AND MAINTENANCE INSTRUCTIONS THOROUGHLY BEFORE INSTALLING OR SERVICING THIS EQUIPMENT.

AVERTISSEMENT: TOUTE INSTALLATION, RÉGLAGE, MODIFICATION, RÉPARATION OU ENTRETIEN INCORRECT PEUT OCCASIONNER DES DOMMAGES MATÉRIELS, DES BLESSURES GRAVES OU LA MORT. LIRE LES INTRUCTIONS D'INSTALLATION, D'UTILISATION ET D'ENTRETIEN ATTENTIVEMENT AVANT D'INSTALLER OU DE RÉPARER CET APPAREIL.



CAUTION: THESE MODELS ARE DESIGNED, BUILT, AND SOLD FOR COMMERCIAL USE ONLY. IF THESE MODELS ARE POSITIONED SO THE GENERAL PUBLIC CAN USE THE EQUIPMENT, MAKE SURE THAT CAUTION SIGNS, WARNINGS, AND OPERATING INSTRUCTIONS ARE CLEARLY POSTED NEAR EACH UNIT SO THAT ANYONE USING THE EQUIPMENT WILL USE IT CORRECTLY AND NOT INJURE THEMSELVES OR HARM THE EQUIPMENT.

ATTENTION: CES MODÈLES SONT CONÇUS, FABRIQUÉS, ET VENDUS POUR UN USAGE COMMERCIAL SEULEMENT. SI CES MODÈLES SONT PLACÉS POUR QUE LE GRAND PUBLIC PUISSE LES UTILISER, ASSUREZ-VOUS QUE LES CONSIGNES D'ATTENTION, D'AVERTISSEMENT, ET LES INSTRUCTIONS D'UTILISATION SOIENT CLAIREMENT AFFICHÉES PRÈS DE CHAQUE UNITÉ DE SORTE QUE N'IMPORTE QUEL UTILISATEUR DE L'APPAREIL L'EMPLOIE CORRECTEMENT ET NE SE BLESSE PAS OU N'ENDOMMAGE PAS L'APPAREIL.



WARNING: A FACTORY AUTHORIZED SERVICE PROVIDER SHOULD HANDLE ALL MAINTENANCE AND REPAIR. BEFORE DOING ANY MAINTENANCE OR REPAIR, FOLLOW SERVICE SET UP ARRANGEMENT ON PAGE 8.

AVERTISSEMENT: UN TECHNICIEN AUTORISÉ PAR L'USINE DEVRA EFFECTUER TOUT L'ENTRETIEN ET LES RÉPARATIONS. AVANT DE FAIRE TOUT ENTRETIEN OU RÉPARATION, VEUILLEZ CONTACTER WINCO.



Introduction

Congratulations on the purchase of the WINCO® equipment. Please take time to carefully read through this manual to ensure the equipment is operated and maintained properly, to ensure the best possible performance from the product for many years.

WINCO will not accept liability for the following if:

- The instructions in this manual have not been followed correctly.
- Non-authorized personnel have tampered with the equipment.
- Non-original spare parts are used.
- The equipment has not been handled and cleaned correctly.
- There is any use damage to the unit.

Immediately Inspect for Shipping Damage

All containers should be examined for damage before and during unloading. The freight carrier has assumed responsibility for its safe transit and delivery. If equipment is received damaged, either apparent or concealed, a claim must be made with the delivering carrier.

- A. Apparent damage or loss must be noted on the freight bill at the time of delivery. It must then be signed by the carrier representative (Driver). If this is not done, the carrier may refuse the claim. The carrier can supply the necessary forms.
- B. If concealed damage or loss is not apparent until after equipment is uncrated, a request for inspection must be made to the carrier within 15 days. The carrier should arrange an inspection. Be certain to keep all contents and packaging material.

Commercial Electric Rice Cooker

Table of Contents

Specifications	1
Warnings	2
Introduction	2
Table of Contents	3
Packaging	3
Important Safeguards.....	4
Preparation & Operation	6
Cleaning, Care & Maintenance	6
Service & Repair	6
Troubleshooting	7
Exploded View	8
Parts List	8
Electrical Diagram	9
Limited Warranty	10

Package Contents

All units come with an Operating Instruction Manual and the following:

- Rice Cooker
- Measuring Cup
- Inner Pot
- Serving Paddle

WINCO® prides itself on quality and service, ensuring that at the time of packing, all products are supplied fully functional and free of damage. Should you find any damage as a result of freight, please contact your WINCO dealer immediately.

Unpacking the Equipment

DISPOSE OF ALL PACKAGING MATERIALS IN AN ENVIRONMENTALLY RESPONSIBLE MANNER.

1. Remove all packing materials and tape, as well as any protective plastic and cardboard, from the unit.
2. Clean any glue residue left over from the plastic or tape.
3. Place the unit in the desired position and height.

SAVE THE ORIGINAL BOX AND PACKAGING FOR USE IN PACKAGING AND SHIPPING THE EQUIPMENT IF SERVICES ARE NEEDED.

Thoroughly read, understand, and follow these instructions before installation and use.

Please keep this manual in a safe place for future use!

NOTE

Please remember that this manual and the warning labels do not replace the need to be alert, to properly train and supervise operators, and to use common sense when using this equipment.

Important Safeguards

To ensure safe installation and operation, please carefully read and understand the following statements.

Unless the operator is adequately trained and supervised there is a possibility of serious injury. Owners of this equipment bear the responsibility to make certain that this equipment is used properly and safely, and to strictly follow all of the instructions contained in this manual and the requirements of local, state or federal law.



Owners should not permit anyone to touch this equipment unless they are over 18 years old, are adequately trained and supervised, and have read and understood this manual.

Owners should also ensure that no customers, visitors or other unauthorized personnel come in contact with this equipment. It is the responsibility of the owner and the operator to remain alert to any hazards posed by the function of this equipment.

If there is ever uncertainty about a particular task or the proper method of operating this equipment, ask an experienced supervisor or contact Winco® for assistance.

Warnings

This manual contains a number of precautions to follow to help promote safe use of this equipment.

	WARNING  AVERTISSEMENT
	USE CAUTION WHEN TOUCHING THE UNIT. Ne touchez pas le liquide chaud ou les surfaces de chauffage lorsque l'appareil chauffe ou en fonctionnement.

FOR YOUR SAFETY

Do not store or use gasoline or other flammable vapors and liquids in the vicinity of this or any other appliance.

ESURE DE SECURITE

Ne pas entreposer ni utiliser de l'essence ni autres vapeurs ou liquides inflammables a proximite de cet appareil ou de tout autre appareil!

WARNING

Improper installation, adjustment, alteration, service or maintenance can cause property damage, injury or death. Read these installation, operating and maintenance instructions thoroughly before installing or servicing this equipment.

AVERTISSEMENT

L'installation, le réglage, la modification, la réparation ou l'entretien incorrect de cet appareil peut causer des dommages matériels, des blessures ou la mort. Lire attentivement les instructions d'installation, de fonctionnement et d'entretien avant de procéder a son installation ou entretien.

TO PURCHASER

Contact your local gas supplier and ask for instructions in the event the user smells gas. This information should be posted in a prominent location.

À L'ACHETEUR

Communiquez avec votre distributeur de gaz et informez vous quant aux procédés a suivre si vous détectez une odeur de gaz. Cette information doit etre affichée a un endroit facile d'accès et tres visible.

Important Safeguards

These instructions should be followed at all times. Failure to follow these instructions could result in injury to yourself and others.

TO REDUCE RISK OF INJURY OR DAMAGE TO THE UNIT:

1. Read this manual thoroughly before installation and operation. DO NOT proceed with installation and operation if you have any questions or do not understand anything in this manual. Contact your representative or the manufacturer first.
2. DO NOT touch any surfaces that may be hot.
3. Unplug from outlet when not in use prior to installing or removing parts and before cleaning. Allow for the device to cool first before handling.
4. To protect against the risk of electrical shock, do not immerse the appliance, cord or plug in water, or other liquids.

	WARNING ⚠️ AVERTISSEMENT	
	Electrical Shock Hazard Keep water and other liquids from entering the inside of the unit. Liquid inside the unit could cause an electrical shock.	Risque de choc électrique Conserver l'eau et d'autres liquides de pénétrer à l'intérieur de l'appareil. Liquide à l'intérieur de l'appareil pourrait provoquer un choc électrique.
	Do not spray water or cleaning products. Liquid could contact the electrical components and cause a short circuit or an electrical shock. Do not use unit if power cord is damaged or has been modified.	Ne pas pulvériser de l'eau ou des produits de nettoyage. Le liquide pourrait contacter avec les composants électriques et causer un court-circuit ou un choc électrique. Ne pas utiliser l'appareil si le cordon d'alimentation est endommagé ou a été modifié.

5. DO NOT operate this device or any other electrical equipment with a damaged cord or plug, or after the unit malfunctions, is dropped or damaged in any manner. Return to the nearest WINCO Authorized Service Center for examination, repair and/or adjustment.
6. The use of accessory attachments not recommended by WINCO may cause fire, electric shock or injury.

	WARNING ⚠️ AVERTISSEMENT	
	Fire Hazard. Correct installation precautions, procedures and regulations must be followed. Operation and safety training is necessary for all users of this equipment.	Risque d'incendie La surchauffe des vapeurs d'huile ou de l'huile peut s'enflammer et provoquer un incendie. Surveillez la température, la qualité et le niveau d'huile. Utilisez et entretenez le système d'élimination des vapeurs d'huile.

7. Not intended for outdoor installation.
8. DO NOT let the cord hang over the edge of a table or counter, or touch hot surfaces.
9. DO NOT place on / near a hot gas / electric burner, or heated oven.
10. This appliance should always be on a stable and steady countertop or table. Allow sufficient space around the cooking area. Never use the unit on/near low-heat-resistant materials (carpet, vinyl).

11. This appliance is not intended for use by individuals (including children) with reduced or impaired physical, sensory or mental capabilities, or lack of experience or knowledge, unless they have been given proper supervision or instruction concerning the use of this appliance by a person responsible for their safety.
12. Any objects that are not intended for use with the appliance should not be in the unit.
13. Clean with caution - if a wet sponge or cloth is used to wipe spills on a hot cooking surface, exercise caution to avoid steam burns. NOTE: some cleaners may produce noxious fumes when applied to a hot surface.
14. Do not store any item on top of this unit when in operation.
15. Never place materials such as paper, cardboard, plastic, etc. on or under this unit.
16. Proper connections and power supply are essential for efficient performance.
17. If an extension cord power-supply is used,
 - a. The marked electrical rating of the extension cord should be rated the same or greater than the electrical rating of the unit.
 - b. The cord should be located so that it does not drape over the counter/tabletop and can not be damaged or moved unintentionally.
18. The units are wired to be used with a standard 120V receptacle and may be plugged into any convenient outlet.
19. The installation of the unit must conform to the NATIONAL ELECTRIC CODE, ALL LOCAL ELECTRIC CODES AND ORDINANCES, AND ALL THE LOCAL ELECTRICAL COMPANY RULES AND REGULATIONS. Additionally, we recommend a 4" spacing surrounding the unit in order to provide adequate ventilation.

Proper Grounding · Mise à la terre correcte

This machine is provided with a three-pronged grounding plug. The outlet to which this plug is connected must be properly grounded. If the receptacle is not the proper grounding type, contact an electrician. DO NOT, under any circumstances, cut or remove the third ground prong from the power cord or use any adapter plug.

Cette machine est équipée d'une fiche à trois broches. La prise sur laquelle cette fiche est branchée doit être correctement mise à la terre. Si la prise n'est pas le type de mise à la terre, contactez avec un électricien. NE PAS, en aucun cas couper ou enlever la troisième broche de terre à partir du cordon d'alimentation ou utiliser un adaptateur.

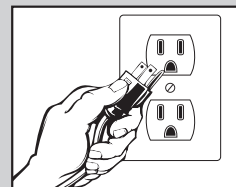

**USE A GROUNDED OUTLET
DO NOT ADD AN ADAPTOR
TO THE PLUG**

**UTILISER UNE PRISE AVEC MISE
À LA TERRE NE PAS AJOUTER UN
ADAPTEUR SUR LA FICHE**

Preparation

It is recommended to clean the inner pot before the first use. **Only use soft cloth or sponge - anything more abrasive will damage the surface.** Do not use abrasive powder or steel wool for cleaning the lid or the inner pan. It will cause damage to the surface.

Operation

1. Measure rice with provided measuring cup.
2. Rinse rice in a separate bowl until water is relatively clear.
3. Place rinsed rice into the inner pot and add water according level indicator.
Example: To cook 10 cups of rice, add water to level indicator 10.
DO NOT cook more than max 30 cups of rice.
4. Place Rice Cooker on a flat leveled surface.
DO NOT incline or slant the unit, this will prevent inner pot from full contact with heating plate causing parts or elements to burn out.
5. Wipe dry the outside of the pot before placing into Rice Cooker. A wet pot may cause a crackling noise while cooking and may damage the unit.
6. Place inner pot into the Rice Cooker. Ensure the pan is directly in contact with the heating plate by turning it slightly from right to left until it sits properly.
7. Place cover on unit, ensuring the lid sits flat without any obstructions.
8. Plug the unit into 120V power source. Press the switch down to initiate cooking. The "COOKING" light will illuminate.
9. After the cooking cycle is complete, rice may be held for approximately 2 hours. Replace lid immediately to maintain product temperature and moisture.
10. When serving rice, be sure to use a plastic or wooden utensils. Using metal utensils may cause damage to non-stick coating on inner pot.
11. Unplug the Rice Cooker when not in use.

Cleaning, Care & Maintenance

To maintain the appearance and increase the service life, clean the unit daily.

Clean all surfaces before using the appliance. Also clean after each day's operation; however, the unit may require more frequent cleaning, depending on the volume of production.

- Switch power off and disconnect from the outlet before cleaning.
- Unplug the unit when not in operation.
- Allow unit to cool before attempting to clean.
- The exterior of the unit may be cleaned by carefully wiping with a damp cloth.
- **DO NOT** immerse the unit in water.
- **DO NOT** clean with a pressure washer.
- Grains of rice or other foreign matter must be removed to ensure full contact of inner pan with heating surface.
- Remove the inner pot and inner lid, dip them into lukewarm water or clean them with mild detergent and rinse completely; dry with soft cloth.
- Do not use abrasive or harsh cleaners on non-stick inner pot.
- The non-stick coating may discolor after repeated uses, but will not affect the non-stick property.

Safety Precautions

Before installing and operating this equipment be sure everyone involved in its operation are fully trained and aware of all precautions. Accidents and problems can result from a failure to follow fundamental rules and precautions.

- A WINCO® Approved Recommended Qualified Service Technician should carry out repairs if necessary. Do not remove any components or service panels on this product.
- Before handling, allow the equipment to cool after use.
- Before cleaning, switch off power and disconnect power cord from the outlet.
- **Do not immerse unit in water or use hose to clean.**
Ne jamais immerger l'appareil dans l'eau ni utilisez un jet d'eau pour le nettoyer.

- If the power cord is damaged, it must be replaced by a WINCO® Approved Recommended Qualified Service Technician in order to avoid a hazard.

THIS EQUIPMENT MUST ONLY BE SERVICED BY AN AUTHORIZED AGENT.

 HOT	WARNING ⚠️ AVERTISSEMENT	
	Burn Hazard. When in operation, the appliance surfaces will be HOT! <i>Please take extreme caution.</i>	Risque de brûlure. En fonctionnement, les surfaces de l'appareil seront CHAUDES! <i>S'il vous plaît prendre une extrême prudence.</i>
USE CAUTION WHEN TOUCHING THE UNIT.	Ne touchez pas le liquide chaud ou les surfaces de chauffage lorsque l'appareil chauffe ou en fonctionnement.	

Troubleshooting

If your equipment unit does not operate, please check the following prior to placing a service call.

ISSUE	MIGHT BE CAUSE BY	RECOMMENDED SOLUTION
The unit is not turning on	Power supply cord or circuit breaker.	Check that the power supply cord is correctly plugged into the outlet. Check outlet for power
	Plug/cord or external wiring is damaged	Remove and replace damaged plug and wiring - <i>Replacement must be done by an authorized service provider.</i>
	Internal wiring fault	
	Blown internal fuse	Remove and replace damaged internal fuse.
Dry rice	Rice left on for an extended amount of time.	Add water to compensate what has been evaporated.
		Reduce the time the rice is kept in the unit.
Rice sticking to pot	Water to rice ratio	Use recommended ratio addressed in manual.
	Rice left on for an extended amount of time.	Reduce the time the rice is kept in the unit.
Cooking switch does not stay pressed	Magnetic temperature sensor	Check insert pot for any dents on the base.
		Check for any debris obstructing the plunger.

Service and Repair

THIS EQUIPMENT MUST ONLY BE SERVICED BY AN AUTHORIZED AGENT.

NOTE

Parts protected by the manufacturer or its agent are not to be adjusted by the installer unless the installer is an authorized service agent.

If you have any questions or problems DO NOT send unit to WINCO® without first contacting our customer service department.

See "Limited Warranty" section on page 10 for details.

Exploded View and Parts List

MODEL: RC-P301

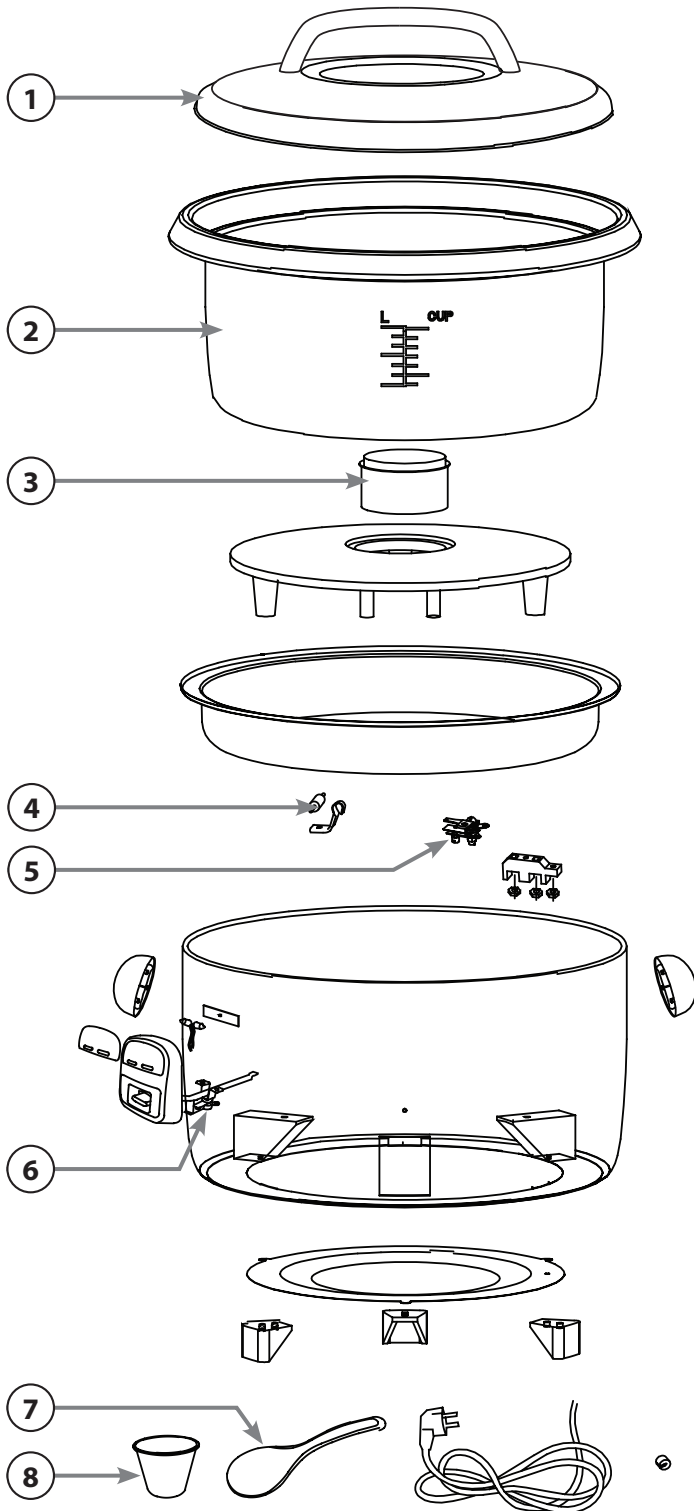

#	Description	Part #
1	Lid	RC-P301LID
2	Inner Pot	RC-P301PN
3	Magnetic Temperature Sensor	RCP301-P11
4	Thermal Fuse	RCP301-P2
5	Thermostat	RCP301-P50
6	Microswitch	RCP301-P9
7	Serving Paddle	RCP301-P47
8	Measuring Cup	RCP301-P48

Please contact factory for special order parts not listed.

Electrical Diagram

MODEL: RC-P301

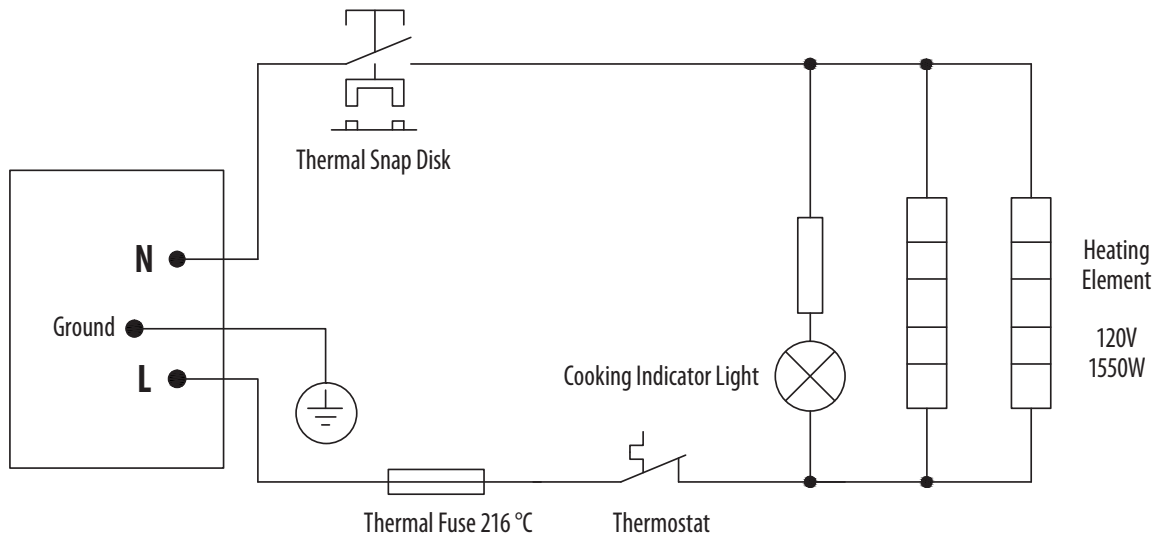

These circuit diagrams have been provided to assist qualified electricians;
only WINCO service agents or qualified electricians should carry out repairs if required.

Do not remove any components or service panels on this product.



Limited Warranty

WINCO® warrants to the original purchaser of new equipment that said equipment, when installed in accordance with our instructions within North America and subjected to normal use, is free from defects in material or workmanship for a period of 1 year. The labor warranty is one year from original installation or 18 months from actual factory shipment date, whichever date occurs first.

THIS WARRANTY IS IN LIEU OF ALL OTHER WARRANTIES, WHETHER EXPRESSED OR IMPLIED. WINCO EXPRESSLY DISCLAIMS ANY IMPLIED WARRANTY OF MERCHANTABILITY OR EXPRESSED OR IMPLIED WARRANTY OF FITNESS FOR A PARTICULAR PURPOSE.

WINCO'S OBLIGATION AND LIABILITY UNDER THIS WARRANTY IS EXPRESSLY LIMITED TO REPAIRING AND REPLACING EQUIPMENT THAT PROVES TO BE DEFECTIVE IN MATERIAL OR WORKMANSHIP WITHIN THE APPLICABLE WARRANTY PERIOD.

IN NO EVENT SHALL WINCO BE LIABLE FOR INCIDENTAL OR CONSEQUENTIAL DAMAGES TO BUYER OR ANY THIRD PARTY, INCLUDING, WITHOUT LIMITATION, LOSS OF PROPERTY, PERSONAL INJURY, LOSS OF BUSINESS OR PROFITS OR OTHER ECONOMIC LOSSES, OR STATUTORY OR EXEMPLARY DAMAGES, WHETHER IN NEGLIGENCE, WARRANTY, STRICT LIABILITY, OR OTHERWISE.

This warranty is given only to the first purchaser from a retail dealer. No warranty is given to subsequent transferees.

Warranty does not cover product failures caused by: failure to maintain, neglect, abuse, damage due to excess water, fire, normal wear, improper set up and use. Periodic maintenance is not covered.

This warranty is not in force until such time as a properly completed and digitally signed Installation/Warranty Registration has been received by WINCO within 30 days from the date of installation.

Limited Warranty (continued)

WARRANTY SERVICE

DO NOT send unit to WINCO® without first contacting our customer service department: 973-295-3899.

To initiate warranty service please visit our online portal:

<https://www.wincous.com/contact-us/product-technical-support>

SCAN FOR ONLINE PORTAL

If having trouble or unable to scan, enter the web address listed above to access the online portal.



Please provide or have the following information available:

- Contact Name, E-mail, and Phone Number
- Company/Organization Name
- Model Number
- Serial Number
- Pictures or Supporting Documentation

Proof of purchase is required to extend warranty more than 1 year from date of shipment from the factory.

THE FOREGOING WARRANTY PROVISIONS ARE A COMPLETE AND EXCLUSIVE STATEMENT BETWEEN THE BUYER AND SELLER. WINCO® NEITHER ASSUMES NOR AUTHORIZES ANY PERSONS TO ASSUME FOR IT ANY OTHER OBLIGATION OR LIABILITY IN CONNECTION WITH SAID EQUIPMENT.

Examples of items not covered under warranty, but not limited to just these items:

1. Natural disasters (ie: earthquakes, tornadoes, hurricanes, etc.), fire, water damage, burglary, accident, theft.
2. Freight damage.
3. Improper installation or alteration of equipment.
4. Use of generic or after-market parts.
5. Repairs made by anyone other than a WINCO® designated service provider.
6. Lubrication.
7. Expendable wear parts, adjustable feet, blown fuses, lamps, etc.
8. Normal product maintenance.
9. Misuse or abuse.
10. Normal wear and tear items such as light bulbs, fuses, and exterior finishes.

Warranty voided if:

1. Product is altered by user
2. Serial number plate is removed
3. Product is installed in a prison or any correctional facility.

Please keep this manual in a safe place for future use!



Model: RC-P301

www.winco.com