



CONTENTS

1	WARRANTY TERM	05
2	SAFETY INSTRUCTIONS	08
3	PRECAUTIONS TO AVOID POSSIBLE EXPOSURE TO MICROWAVE ENERGY	11
4	INSTALLATION	13
5	ROCKET EXPRESS TECHNOLOGY	17
6	OPERATION PRINCIPLES	19
7	RECIPES CREATION	20
8	OPERATION	21
8.1	PREHEATING	21
8.2	EXECUTING A RECIPE	21
8.3	ACCESSING THE OPTIONS	23
8.4	USER'S SETTINGS	23
8.4.1	EDIT GROUPS	24
8.4.2	EDIT RECIPES	27
8.4.3	PREHEAT	32
8.4.4	USB	32
8.4.5	LANGUAGE	33
8.4.6	CURRENT TEMPERATURE	33
8.4.7	DATE/TIME ADJUSTMENT	33
8.4.8	CELSIUS/FAHRENHEIT	34
8.4.9	CHANGE PASSWORD	34
8.4.10	EDIT ACCESSES	34
8.4.11	MANUFACTURER'S INFORMATION	35
8.4.12	TECH SUPPORT	35
8.4.13	RESTORE FACTORY SETTINGS	35

CONTENTS

8.5 FAVORITES	35
8.6 MANUAL MODE	37
8.7 DAILY CLEANING GUIDE	38
8.7.1 CATALYTIC CONVERTER CLEANING GUIDE	41
8.7.2 AIR FILTER CLEANING GUIDE	41
9 ALERTS AND ERRORS: POSSIBLE SOLUTIONS	42

LETTER TO CUSTOMERS

Prática Inc. are proud to become part of your day-to-day lives with our products. By purchasing Prática's appliances, you will have a partner that always will be attentive to your needs and interested in keeping customers satisfied.

We are available to serve you at any time, whether it is to hear your ideas, criticisms, suggestions, or solve a problem.

Count on us!

Our Mission

Bring quality and productivity to the food preparation environment.

Our Commitment

- Always knowing and meeting the needs of our customers.
- Offering reliable, high-performance, and energy-efficient products.
- Always looking for improvements of processes, products and cost to offer more value to our customers every single day.
- Treat our customers with complete honesty and respect.
- Prática Inc. donates a portion of our profit to charitable causes.

1 WARRANTY TERM

1.1 Terms and detailing

- a) Our products have a legal warranty of three months and contractual warranty of nine months (one year in total) from purchase invoice issuance date and applies only to the first purchaser. If for any reason the purchase invoice cannot be found, the equipment manufacture date contained in the indicative label will be considered as the start date of enforceability of this warranty. The following will be covered under warranty.
- b) Regardless of the actual installation or use of the equipment, the warranty period is started per the date of issuance of the purchase invoice.
- c) For delivery and installation of the equipment, Prática will send, at no cost to the customer, an authorized technician to the site where the appliance will be installed (or the customer can call a technician of their choice, if preferable).
- d) If new visits are needed to complete the delivery/installation of the product due to the lack of adequate, electrical, or exhaust related conditions, the costs of such visits shall be the customer's responsibility.
- e) For the appliance's installation, the customer must provide all conditions required (water, light, gas, grounding and exhaust if needed) in the installation blueprint. The customer will also be responsible for transporting the equipment to the installation site.
- f) The warranty only covers manufacturing and component failures.
- g) The warranty will cover maintenance, adjustments or replacement of defective parts. It is the responsibility of the customer or technician to return the defective parts to Prática Inc. for analysis.
- h) Warranty service calls will not justify the extent of the warranty, returns or exchanges of the equipment, or any other type of claim.

1.2 Warranty Exclusions

- a) The customer should thoroughly inspect the equipment upon delivery and contact the carrier in case of shipping damage arising from transport. At the time of installation, the technician should find the equipment in its original packaging (fully preserved).
- b) Irregularities in building installation systems.
- c) Please use the Installation and Operation Manual that are included with the product.
- d) Failure to observe the installation details per the Installation and Operation Manual, such as: uneven floors, installing the oven next to equipment that exude fat, heat or solid particles, lack of air circulation, etc.
- e) Any damage and defects resulting from inappropriate cleaning that causes damages to the components will not be covered under warranty. For example, pouring water inside the electric panel, etc.
- f) Changes performed by unauthorized technicians in the original conditions of installation such as electrical distribution, installation location, etc.
- g) Use of aggressive or abrasive products that are unsuitable for cleaning which may tarnish, wear, scratch or damage accessories or equipment components.
- h) Damage and operational failures arising from unfiltered water with great calcium content or electrical supply with voltage oscillation or noise/interference in power line.
- i) Occurrences from electrical discharges arising from acts of nature or voltage peaks caused by generators or supply companies.
- j) Damage to the equipment or its accessories because of accidents, abuse, improper operation, improper handling or Installation as described by the Operation Manual included with this product.

- k) Repair attempts by unauthorized third parties or use of non-OEM parts and components, regardless of the damage or defects.
- l) Wear and tear components are excluded from the warranty such as lights, seals, belts, bearings, chains, tarps, glass, plastics, etc.

1.3 Notes and Recommendations

- a) The operator can use the Installation and Operation Manual as a guide.
- b) Make sure that the electric and exhaust systems are made and installed by a qualified company or technician.
- c) Before contacting technical assistance, check the manual for troubleshooting tips that can be solved without a technician.
- d) The wear and tear of the unit is not covered by warranty. To ensure productivity and increase the life of the product, it is essential to perform the daily cleaning and a preventive maintenance regularly.
- e) You can call our technical assistance to provide feedback, offer suggestions, or get assistance troubleshooting during normal business hours at: +1.214 584-6269.

EQUIPMENT IDENTIFICATION

(Fill in to make technical support calls easier)

MODEL			
VOLTAGE		SERIAL NUMBER	
RESELLER			
INVOICE NUMBER		PURCHASE DATE	

2 SAFETY INSTRUCTIONS

- Read the manual carefully before installing the appliance.
When carrying out the daily cleaning, please use personal protective
- equipment such as protective gloves, apron, mask and goggles.



Protective Gloves



Protective Mask



Apron



Goggles

- The appliance **MUST** be grounded.
- The oven must have a dedicated circuit breaker.
- Do not immerse the power cord or connect water.
- Keep the power cord away from heated surfaces.
- Do not let the power cable hang over the edge of the table or counter.
- If the power cord is damaged, it must be immediately replaced by an authorized technician to avoid shock hazard.
- Only qualified personnel should open the equipment panel.
- Do not use plastic utensils.
- Do not use the Microwave function without food as it can damage the appliance.
- Do not operate the equipment with the door open due to microwave energy exposure.
- Do not place any object between the door and the oven door.
- Do not allow food residue or other debris to accumulate on the surface of the door and hinge to avoid damaging the appliance.
- Do not use the appliance if it is damaged. The oven's door should always close properly.
- Foods with skin, bark or membrane, such as tomato, potato, sausage, must be punched with a fork as they may explode.
- Fully sealed packages should not be heated in the oven as they can explode.
- Use this appliance only for the functions described in this manual.
- Do not allow children to use or operate this appliance.
- Do not cover or block any air vents on unit.
- Do not use the appliance outdoors or without coverage.

- Do not use this product near water such as near the kitchen sink, in a wet basement, or near a swimming pool.
- Do not use a water jet for cleaning. Please see cleaning instructions for proper cleaning.
- When cleaning the surface of the oven use only non-abrasive products applied with a nylon sponge or soft cloth (page 39).
- To reduce the risk of fire in the oven cavity:
 - Remove wires used to seal paper or plastic bags that will be into the oven.
 - Carefully monitor equipment when materials such as paper, plastic, and other combustible materials are placed inside the oven for easy cooking.
 - Remove all contents located inside the oven cavity.
 - If the product catches fire inside the cook cavity, close the door immediately and turn the unit off or unplug it. The power can also be turned off at the circuit breaker.
- Do not use the cavity of the appliance for storage.
- Always wear thermal gloves or use holders or tongs to remove the food from inside the equipment to avoid burns.
- Liquids heated in the microwave can cause delayed eruption due to thermal shock.
- The appliance is not intended for use by persons (including children) with reduced physical, sensory or mental capabilities, or that have not been properly trained to operate the unit.
- Liquids, such as water, coffee, or tea are able to be overheated beyond the boiling point without appearing to be boiling. Visible bubbling or boiling when the container is removed from the microwave oven is not always present. THIS COULD RESULT IN VERY HOT LIQUIDS SUDDENLY BOILING OVER WHEN THE CONTAINER IS DISTURBED OR A UTENSIL IS INSERTED INTO THE LIQUID.
- The minimum height of free space above the microwave should be of 5.9in (150mm).
- Only use utensils suitable for use in microwave ovens.
- When heating food in microwave safe container, check the oven frequently due to the possibility of ignition.
- The oven should be cleaned daily and any food remains should be removed.
- Failure to maintain the oven in a clean condition could lead to deterioration of the surface that could adversely affect the life of the appliance and possibly result in the loss of warranty.

- **CAUTION:** To avoid burns, do not use containers with liquids or kitchen products that become liquids by heating up to boiling point. This marking must be mounted after installation at 5.25in (1.6m) above floor level.



- Do not operate any heating or cooking appliance beneath this appliance.
- Do not mount unit over or near any portion of a heating or cooking appliance.
- Do not mount over a sink.
- Do not store anything directly on top of the appliance surface when the appliance is in operation.
- Oversized foods or oversized metal utensils should not be inserted in a microwave/ toaster oven as they may create a fire or risk of electric shock.
- Do not clean with metal scouring pads. Pieces can burn off the pad and touch electrical parts involving a risk of electric shock.
- Do not use paper products when appliance is operated in the toaster mode.
- Do not store any materials, other than manufacturer's recommended accessories, in this oven when not in use.
- Do not cover racks or any other part of the oven with metal foil. This will cause overheating of the oven.
- Do Not Clean Door Gasket – The door gasket is essential for a good seal. Care should be taken not to rub, damage, or move the gasket.
- Do Not Use Oven Cleaners – No commercial oven cleaner or oven liner protective coating of any kind should be used in or around any part of the oven.
- It is necessary to remove and remove the air filter frequency, for more details go to page 39 of the manual.
- Daily cleaning is required to remove grease from equipment. For more details, see page 41 of the manual.
- Some products such as whole eggs and sealed containers – for example, closed glass jars – are able to explode and should not be heated in this oven.
- Use this appliance only for its intended use as described in the manual. Do not use corrosive chemicals or vapors in this appliance. This type of oven is specifically designed to heat, cook, or dry food. It is not designed for industrial or laboratory use.
- Clean Only Parts Listed in Manual.

3 - PRECAUTIONS TO AVOID POSSIBLE EXPOSURE TO EXCESSIVE MICROWAVE ENERGY

(a) Do not attempt to operate this oven with the door open since open-door operation can result in harmful exposure to microwave energy. It is important not to defeat or tamper with the safety interlocks.

(b) Do not place any object between the oven front face and the door or allow soil or cleaner residue to accumulate on sealing surfaces.

(c) Do not operate the oven if it is damaged. It is particularly important that the oven door close properly and that there is no damage to the: (1) Door (bent), (2) Hinges and latches (broken or loosened), (3) Door seals and sealing surfaces,

(d) The oven should not be adjusted or repaired by anyone except properly qualified service personnel.



EQUIPOTENTIAL BONDING SYMBOL: This symbol identifies the terminals which, when connected together, bring the various parts of an equipment or of a system to the same potential, not necessarily being the earth (ground) potential, e.g. for local bonding.



PROTECT EARTH (GROUND) SYMBOL: This symbol identifies the terminal which is intended for connecting an external conductor for protection against electric shock in case of a fault, or the terminal of a protective earth (ground) electrode.



MICROWAVE WARNING SYMBOL: This symbol identifies there is a risk of external and internal burns of body parts following exposure to microwave energy.



HOT SURFACE WARNING SYMBOL: This symbol identifies There is a risk of burns from high temperatures inside the cavity and on the inside of the appliance door.



HIGH VOLTAGE WARNING SYMBOL: This symbol identifies a risk of high voltage electric shock.

4 INSTALLATION

The installation of our products must be done with care to avoid problems or damage to the equipment and guarantee its optimal performance. This appliance must be installed by an authorized technician.

WARNING

- This oven is not intended for built-in installation (i.e., installing the oven in any structure that surrounds the oven by five or more sides).

4.1 Dimensions

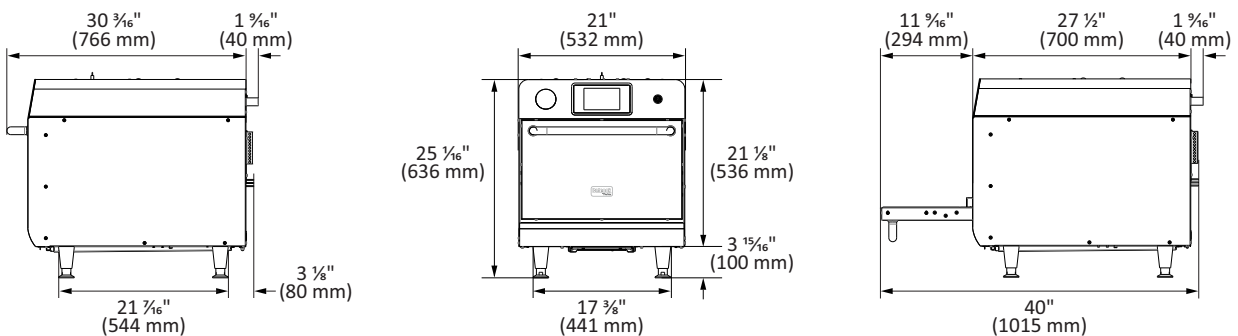

Chamber Dimension	
Capacity	21 Liters
Height	5 $\frac{3}{4}$ " - 146 mm
Width	15 $\frac{1}{2}$ " - 394 mm
Depth	14 $\frac{1}{4}$ " - 362 mm







4.2 General Instructions

- The oven must be installed on a surface or counter that supports its weight of approximately 194lb (88 Kg).
- Do not block the air inlets or outlets of the unit.
- The oven must not be positioned near stoves, deep fryers, hot plates and other equipment that releases fat, fumes and heat. The ventilation, electrical panel and motor vents must be far from these heat sources to prevent damage to the electrical system of the appliance.
- The oven must be installed in a leveled and well ventilated area.
- The installation of the equipment in a non-suitable place can result in the loss of warranty.

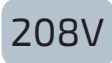
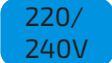

4.3 Electric Power

Note: The oven must be properly configured for optimum performance before using for the first time. Follow the steps listed below to set the oven operating system to either 208V or 240V supply voltage based on the voltage being supplied at the oven's receptacle. This configuration step is only performed on the initial set-up and installation. The oven will not need to be configured again as long as the supply voltage remains unchanged.

The ovens are shipped in a defaulted position of 240V for safety unless specified on the original purchase order. Changes to this set voltage can be easily done by following the instructions listed below. ***Please contact Pratica Technical Support for more information if needed +1.214.584.6269.***

1. Verify the supply voltage. If this knowledge is not readily available, please use a qualified technician or individual familiar and comfortable with electricity to take the measurements. Care must be used to avoid electrical shock. Confirm the electrical configuration of the receptacle conforms to the electrical specification in the table below and written on the oven's data plate located on the back of the unit.
2. Connect the oven to the power supply and turn on.
3. Press  for access to Menu screen.
4. Press  to enter the Settings screen.
5. Enter password 456789 and press **OK** for access to user settings.
Note: The password may be changed (see page 34).
6. Press  to access the second Settings screen.
7. Press  to enter the Voltage screen.
8. Press  or  to set the correct voltage.
9. The oven is now ready for use, press the  and confirm  to back to the Preheating screen.

Make sure that the electrical characteristics of building electric network follow the technical specifications of the oven which can be found on the identification plate located on the back panel and in the electrical table below.

Region	Voltage (V)	Phases	Freq. (Hz)	Power (kW)	Circuit Breaker (A)	Cable	Socket	
USA	208	Single	60	6.2	32	3x10AWG	NEMA 6-30	
	240			7.2				
Europe	230	Single	50	6.9	32	3x4mm ²	32A (2P+T)	
	230	Multi	50	6.9	32	3x4mm ²	32A (2P+T)	

Use a dedicated circuit breaker for the oven. The maximum distance between the right side of the oven and the electrical receptacle is 5 ft.

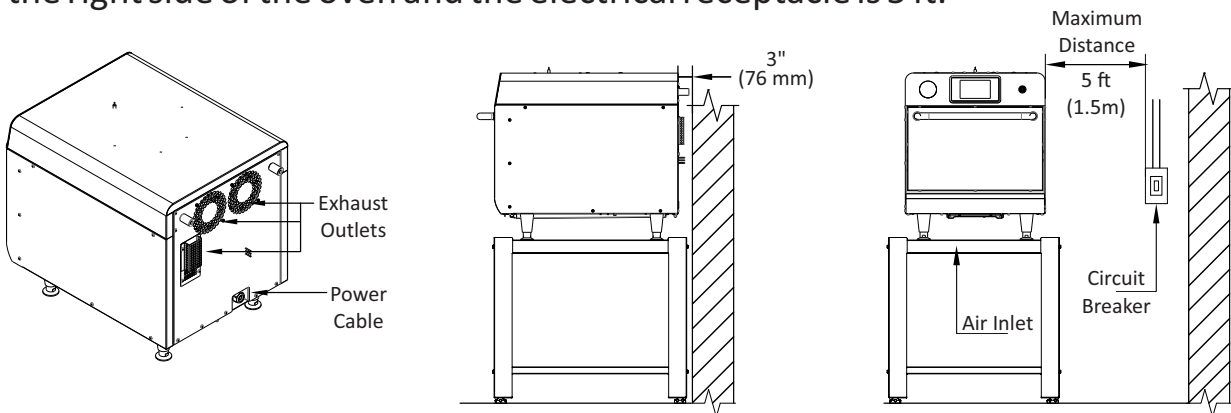

- Properly size the circuit breaker and network cables.
- The oven **MUST** be properly grounded. In the event of damage due to improper grounding to third parties and/or to the equipment, the will be held responsible and will characterized as negligence due to the non-compliance with the standards.
- There is an equipotential point on the rear panel of the oven.

•Note: The equipment has an interconnect connector for other equipment. This connector is intended to keep several devices with the same electrical potential. Not necessarily the grounding of a local connection. This connector on the rear of the device is identified by the symbol on the right:



5 ROCKET EXPRESS TECHNOLOGY

The *Rocket Express* oven uses a combination of heating for high-speed forced air convection and microwave energy to heat forced food more quickly than the conventional methods.

The figure below illustrates the steps involving the technology:

- a) Internal heating elements transfer thermal energy to the circulating air.
- b) The blower motor circulates air at high speed and envelops the food.
- c) The circulating air goes through the catalyst where the grease laden vapors are broken down.
- d) The bottom heater helps the heat transfer within the chamber.
- e) At the same time, Magnetrons generate energy via microwave that evenly heats the food water molecules.

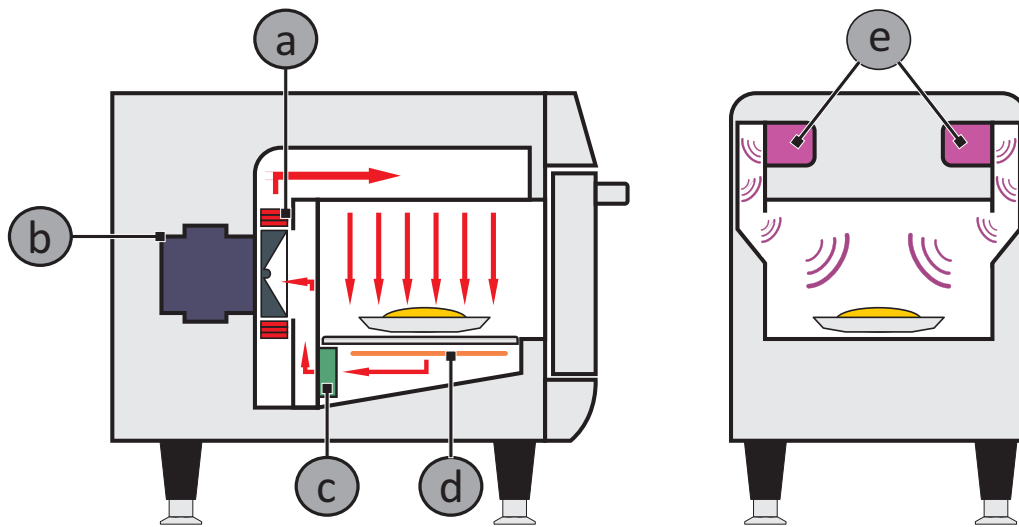

6 OPERATION PRINCIPLES

Microwaves are a type of radiant energy. As well as radio waves, visible light and infrared, the microwaves are part of the electromagnetic spectrum, i.e., it is a form of electromagnetic radiation. They are classified as non-ionizing radiation, because unlike x-rays and Alpha, Beta and Gamma rays, its effects are strictly thermal and therefore do not alter the molecular structure of the item that is being irradiated.

The basic principle of microwaves is to cook by molecular vibration. They penetrate the food surface in a depth that ranges from two to seven centimeters, heating the molecules of water, fat and sugar by making them vibrate. The heat is transmitted to the interior of the food by thermal conduction, demystifying the idea that the microwaves cook food from the inside out.

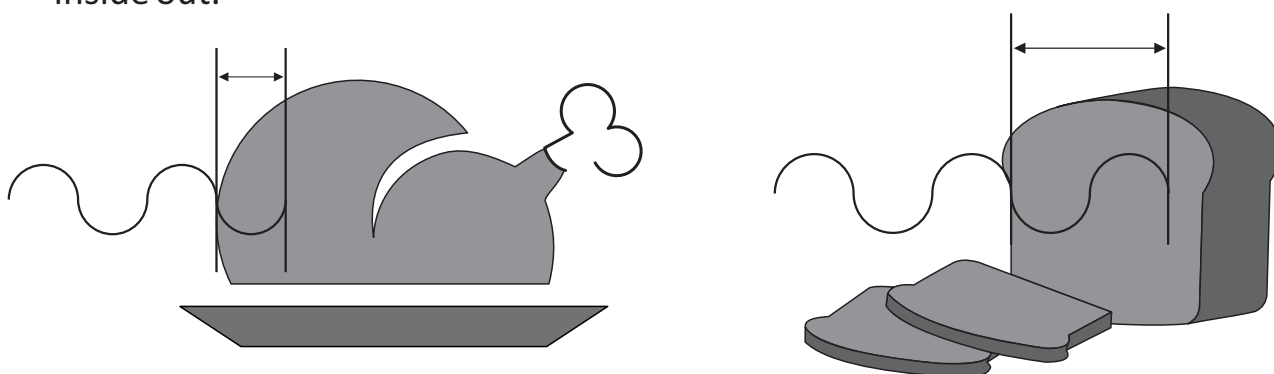

The Rocket Express works through the association between microwaves and hot air directed towards the food. The variables in the operation consist of:

- a) Operation time.
- b) Chamber temperature.
- c) Microwaves power.
- d) Air speed.

Each operation recipe can be programmed with up to six steps and each of them can have the variables mentioned above.

Temperatures: The preparation times are short and so are the steps. The temperature variation between steps will not be observed by the unit. Normally the temperature used is the same temperature as the cook cavity set point.

Microwaves: The microwave is adjustable between 0% and 100% for each 30 second fraction. For example, the microwaves in a one-minute recipe with microwave programmed at 50% will run for 15 and stop for 15 seconds. Then they will energize for another 15 seconds and stop for the remaining 15 seconds. In 1 minute, they will act for a total of 30 seconds. The microwaves heat the food internally and do not require a specific mean to propagate. Microwaves are reflected by metals but will penetrate glass, plastics, and ceramics. The microwaves penetrate food and become attracted to sugar, fat and water molecules.

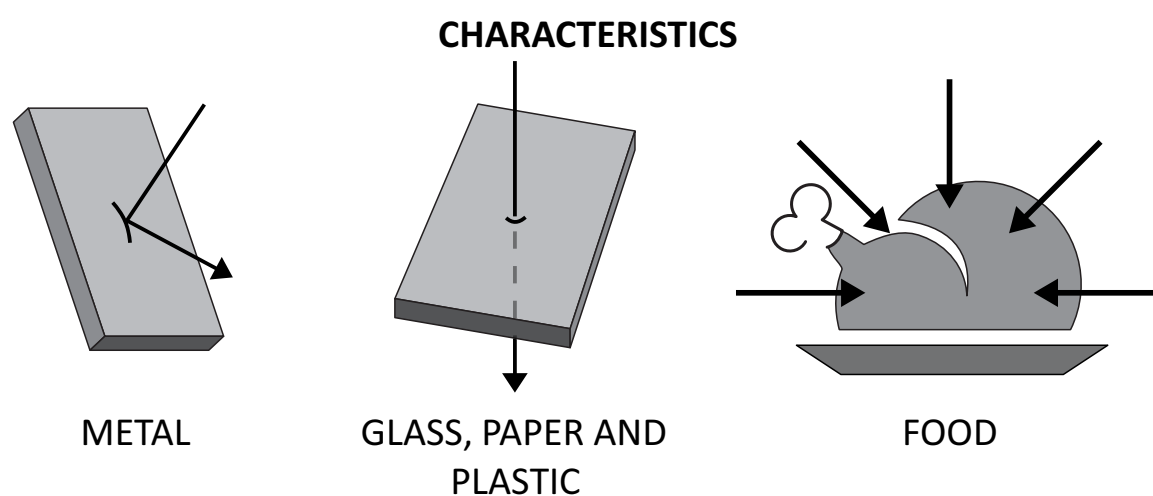

The use of plastic or paper containers is forbidden because they will burn inside the oven because of the heat.

Operation Time: The food heated by microwaves occur from the outside in and the penetration level will vary depending on the type of food. Therefore, you should relate the preparation time to the food composition, the quantity of food processed, as well as its density and thickness. The larger the food amount (quantity or density), the greater the time or percentage will be needed for the microwave to take effect.

Hot Air Speed: The hot air can be adjusted between 10% and 100% speed. The hot air is controlled by a blower motor which will envelope the food.

- a) The higher the air speed, the more likely it will be to burn the product on the outside.
- b) The higher the air speed, the more it will affect the texture and crispness of the product.

7 RECIPES CREATION

When creating a recipe, all the variables mentioned earlier should be considered. The microwaves and the air speed are the critical factors for a successful preparation.

To get faster results in the recipe creation, we suggest beginning programming at 1/10 of the total time of preparation used in a conventional process.

The effect of microwaves is more efficient at the beginning of the processes. For frozen products, create a recipe with two or three steps so the food will thaw at the beginning and the desired crispness and product presentation are achieved toward the end of the process.

Later, combine the air speed variations to reach the desired crispness and color. Remember, the air also transmits heat to the food so keep that in mind when setting blower percentage. The food's weight, size, and shape are critical when setting the total cook time.

The following information is critical when creating a new recipe.

- a) The initial temperature of the product will change the desired results if not considered (e.g.; frozen, cold, or room temperature).
- b) The size and/or weight variation of the portion of product will also play a crucial role in determining the correct settings.
- c) Only use containers approved for a microwave oven to prevent any damage and that the product gets properly cooked.

8 OPERATION

8.1 Preheating.

- a) To start the oven preheating process, after turning on the equipment, choose between Temperature 1 and Preheating Temperature 2.
- b) The following screen will present the CURRENT, PROGRAMMED temperature and the bar indicating the remaining time to utilize the equipment.
 - **Note:** The timer is only initiated when the CURRENT temperature is next to the PROGRAMMED; that occurs so that the oven temperature enters in uniformity throughout the chamber.

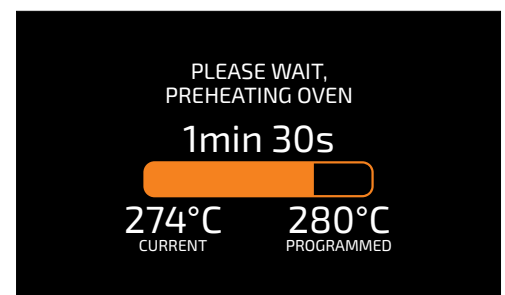
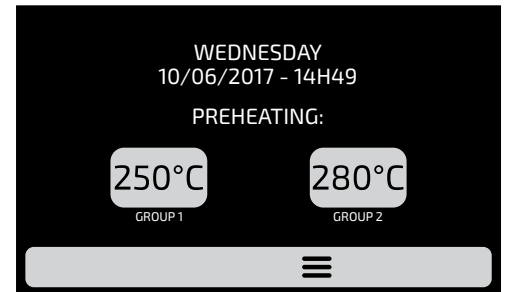

8.2 Executing a recipe.

- a) After the preheating.
 - Activate the desired GROUP. To access the next groups page, utilize the paging arrows: ◀ / ▶.
- b) The RECIPES of the selected group will be displayed, press on the recipe you wish.
 - To return to the GROUPS screen, push the button: 🏠.
 - To access the next recipes page, utilize the paging arrows: ◀/▶.

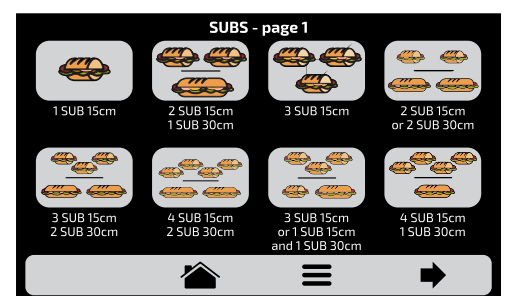
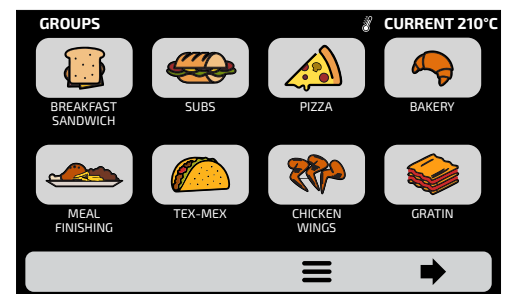

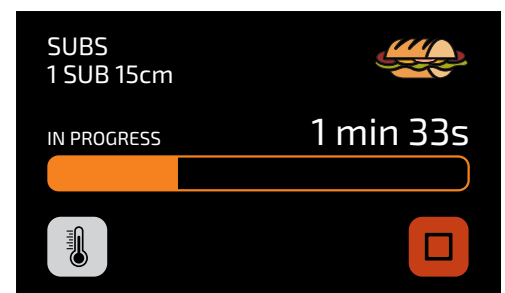

Make sure there is food inside the oven, otherwise it will cause damages to the equipment.

- c) The recipe will enter in execution immediately.
- d) The screen will present the group name, recipe name, situation of the operation (In progress or paused), and the remaining time for conclusion of the recipe.



e) It is possible to verify the temperature of the TOP HEATER and of the BOTTOM HEATER pressing the  button.

f) In case you wish to cancel the execution of a recipe, push the  button.

g) If the equipment door is opened, the operation will be paused, once the door is closed again just push the  to resume the operation.

h) If the programmer of the recipes adds information in one of the steps, for example: 'ADD THE TOMATOES', the recipe will be paused and the description of the information will be presented beside the PLAY button, as in the opposite image: Push the  button to resume the execution.

i) After the completion of a recipe, the following options will be released:

 **Cook/Brown More:** Activates the microwave and hot air during a predetermined time.

 **Brown More:** Activates only the hot air during a predetermined time.

 **Cook More:** Activates only the microwave during a predetermined time.

 **Repeat Recipe:** Repeats the same recipe chosen by the user.

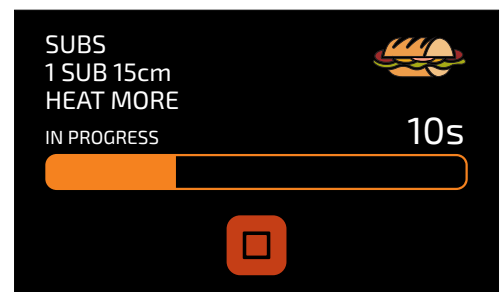
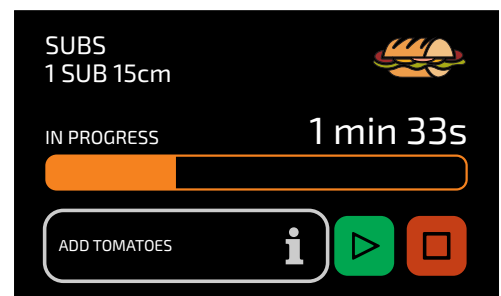
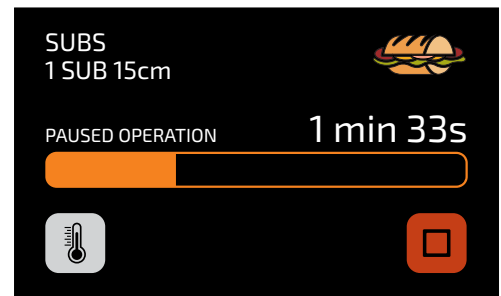
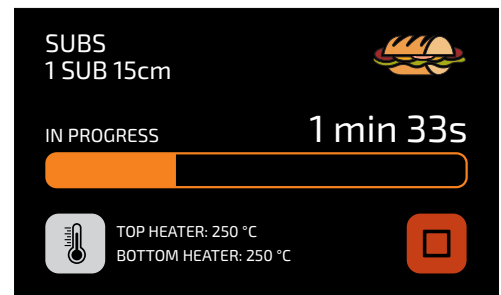

j) In 'Cook/Brown More', 'Brown More' and 'Cook More', the time will be defined at the moment of creating the recipe.

k) **The four options mentioned above may be disabled so that they do not appear in any recipe. Learn more in the User's Settings block: Edit Accesses (see page 34).**



Example of Heat More in execution:

8.3 Accessing the Options.

- a) To access the settings, at any time, touch on the icon  found in the fixed menu bar.
- b) In the Options Screen, there will be information such as: Current temperature in the Chamber, Current temperature of Bottom Heater (**IR**), Favorites (see page 36), Manual Mode (see page 37), Daily Cleaning Guide (see page 38) and Settings (below).
- c) Touching on the icon  once more will return to Recipes Groups.
- d) Touching on the icon  will return to the Preheating Temperature selection screen.

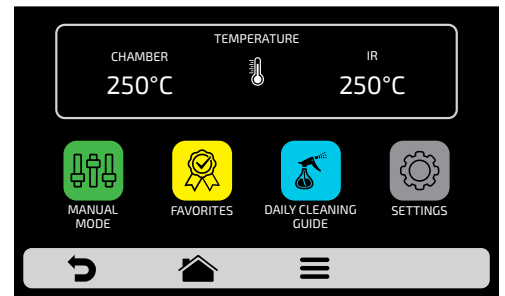
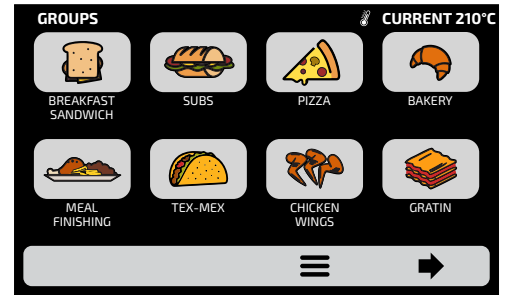

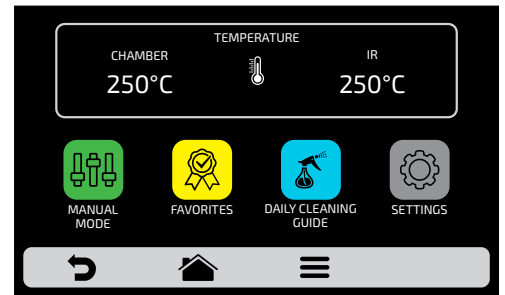

8.4 User's Settings.

Inside the Options Screen, click on the icon  on the screen to inform the User's Password that will be presented.



The standard password for the settings is 456789. The password may be changed (see page 35).

The User's Settings screen is composed by fifteen items. Use the arrows to access the next options screen:  / . Understand each item in detail in the following pages.

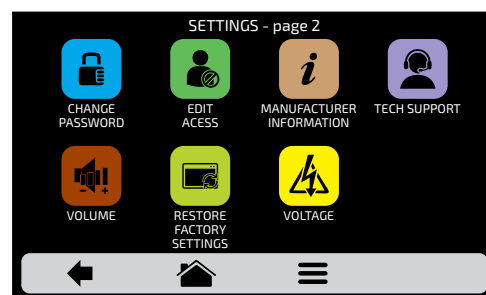
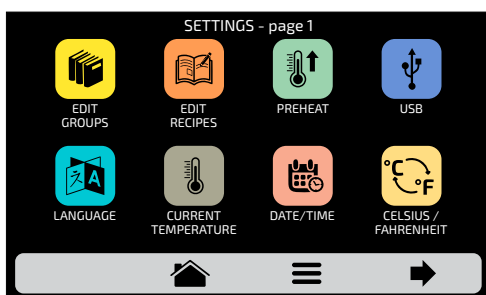
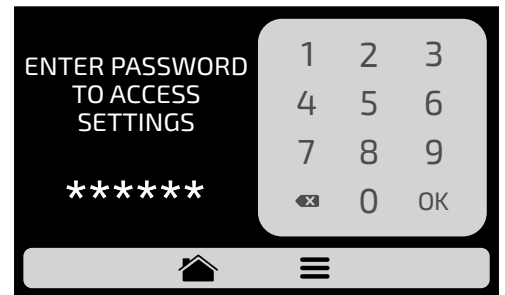

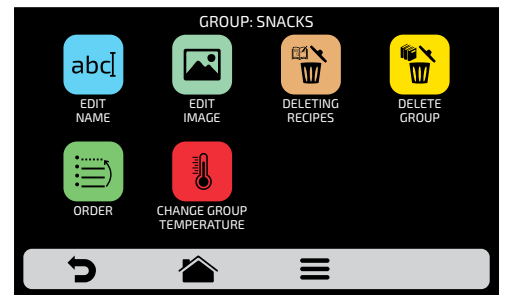
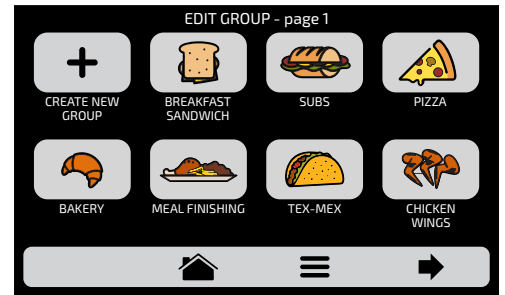
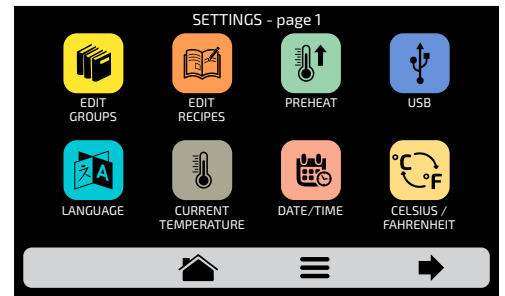

8.4.1 User's Settings: EDIT GROUPS.

- To edit the groups, touch on the  icon, the groups screen will be presented. However, in the first position will be the icon in which it is possible to Create New Group.
- Choose between creating a new group, or select the group you wish to edit. It is possible to have up to a total of sixteen groups.
- The available options after choosing between editing or creating a group will be:



 **Edit Name:** changes the group's name, you may use letters, numbers or special characters.

 **Edit Image:** changes the image the group icon takes.



 **Delete Group:** deletes all the information of the selected group, including the recipes.

 **Deleting Recipes:** deletes the previously selected recipes.

 **Order:** orders the location in which the group appears among the existing groups.

 **Change Group Temperature:** changes the preheating temperature group.

8.4.1.1.Edit Name.

- When selecting the Edit Name option, the following screen will be presented:
- Clicking on **123/-*** and **ABCDE** the screen will toggle between letters and numbers/special characters.
 -  Deletes a character;
 -  Space bar;
 -  Saves the name and returns to the options.

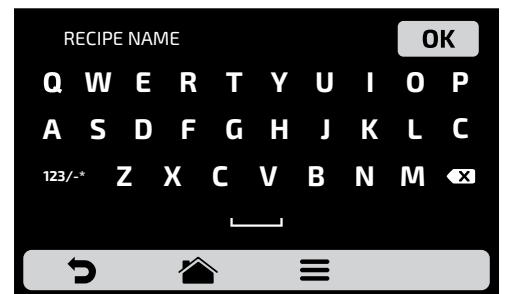

8.4.1.2. Edit image.

a) Rocket Express has an image gallery that enables the user to change the images of the groups. Press the icon .

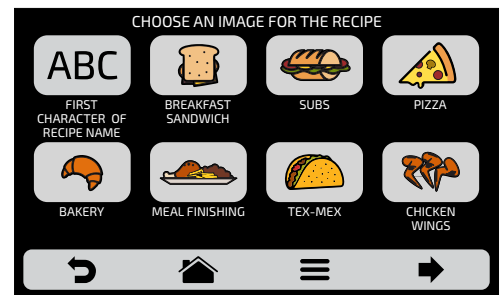

b) A screen with an image library will be presented, browse through the groups and select the desired image. It is also possible, instead of adding an image, to maintain the first letter of the group name as the group icon, just click on the ABC icon.

For example: if your group is called SNACKS, on the group screen, Snacks will have letter 'S' as its icon.

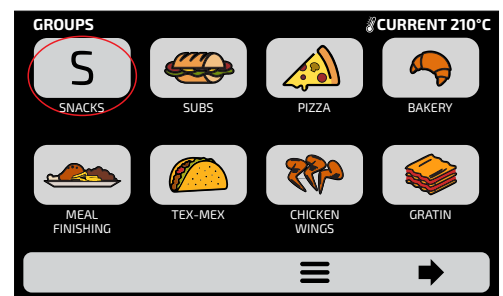

8.4.1.3. Deleting Recipes.

a) The delete recipes option will enable you to delete only the recipes of the previously selected group. Press the button.  On the next screen, it will be possible to delete a selection of recipes, or all the recipes:

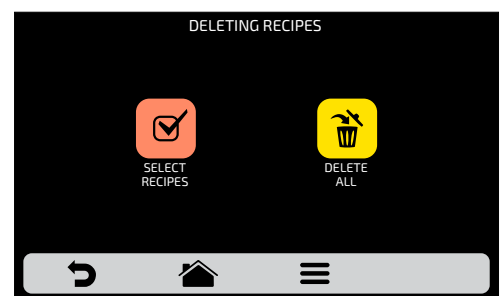

b) **Select recipes:** 

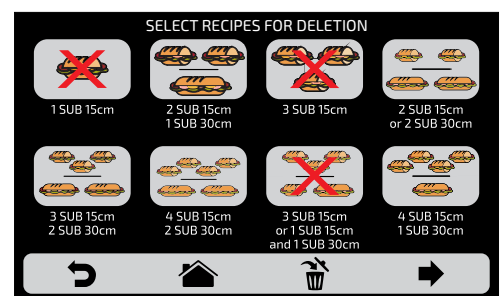

- Select the recipes you wish to delete, the **X** will indicate the selected ones, and then click on the trash can of the fixed bar .



- The opposite message will appear - To confirm the exclusion of the recipes, click on the icon 'DELETE SELECTION'; to continue selecting, click on 'CONTINUE SELECTION'.



c) **Delete All:** 

- When clicking on the Delete All icon, the following message will be presented:

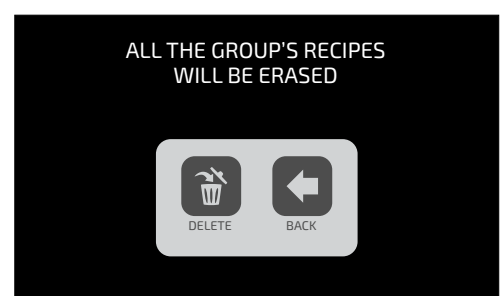
- To confirm, click on  or, to cancel, and return click on .



8.4.1.4. Delete Group

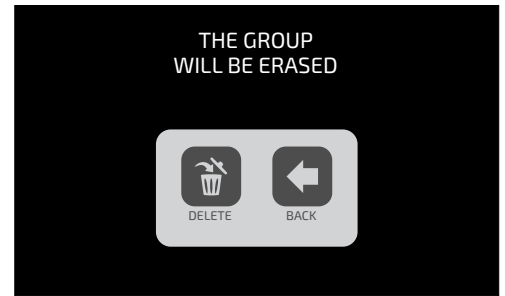

- ATTENTION:** When choosing the option of deleting the group, all the information referring to the group will be lost: recipes, steps and other information. And in case the user does not perform a Backup (see page 32, USB Options), it will not be possible to recover this information.
- Press the button  to confirm your choice, or  to return to the options screen.

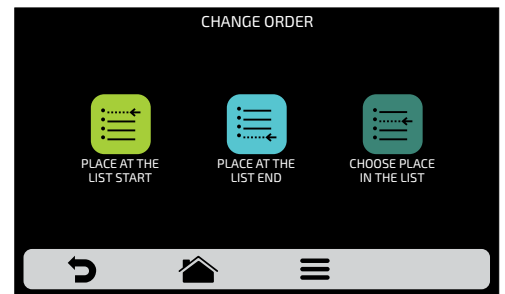

8.4.1.5 Order

- The Order function , enables to change the sequence in which the groups will appear on the groups screen. This screen is composed by three buttons:



-  **Place at the list start:** The group is moved to the beginning of the groups list.
-  **Place at the list end:** The group is moved to the end of the groups list.
-  **Choose place in the list:** The operator will be directed to the groups screen to choose the location he/she wants.



- According to adjacent screen, if the chosen group at the beginning of the editing process is PIZZA, and the user wishes to place it before LASAGNA, just click on the LASAGNA icon. **Observe by the example that the origin and destination location are not replaced, the software just reorders the groups.**

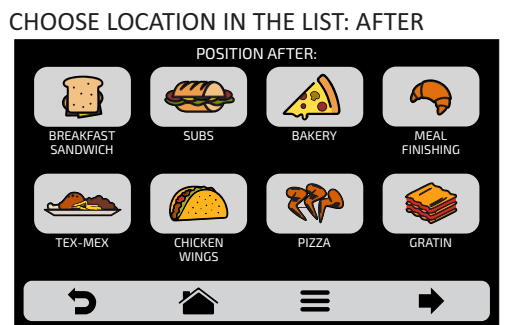

8.4.1.6 Change Group Temperature

- Choose the desired preheating temperature to the selected group.

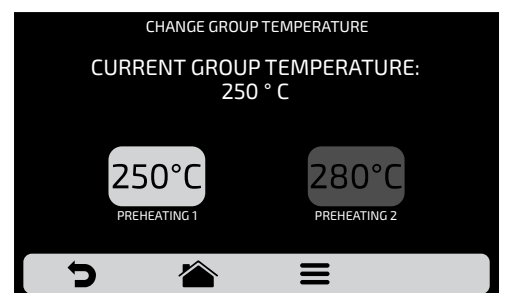

8.4.2 User's Settings: EDIT RECIPES.

a) To edit the recipes, touch on the icon . The groups screen will be displayed. Choose in which group you wish to change the recipes.

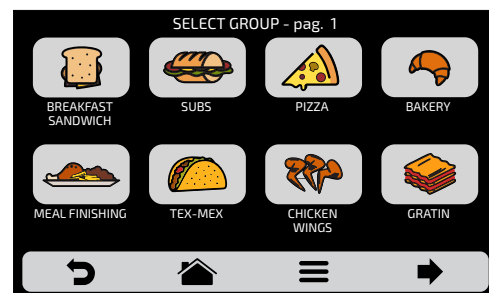

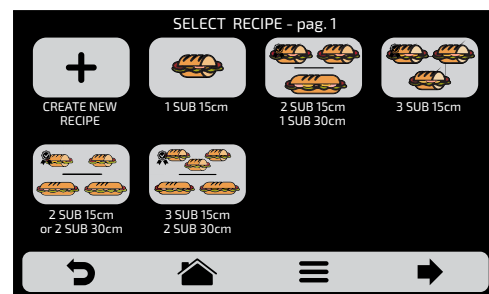

b) When accessing the recipes, it will be possible to edit an already existent one or create a new recipe.



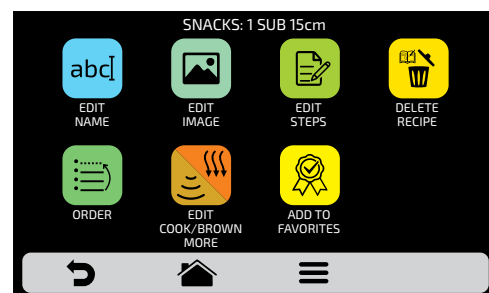

c) The available options after choosing between editing or creating a recipe will be:





 **Edit Name:** changes the name of the recipe, you may use letters, numbers or special characters.

 **Edit Image:** changes the image the recipe icon takes.

 **Edit Steps:** accesses the options for edition of the steps of the selected recipe.

 **Delete Recipe:** deletes all the information of the selected recipe, including the steps.

 **Order:** orders the location in which the recipe appears among the other recipes of the group.

 **Edit Cook/Brown More:** Changes the time of Cook / Brown More function.



 **Add/Remove from Favorites:** Adds or removes the recipe in the Favorites list.

8.4.2.1. Edit Name.

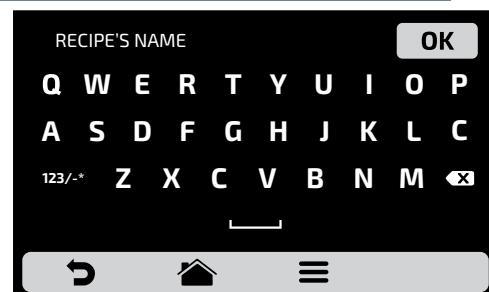
a) When selecting the Edit Name option, the following screen will be presented:



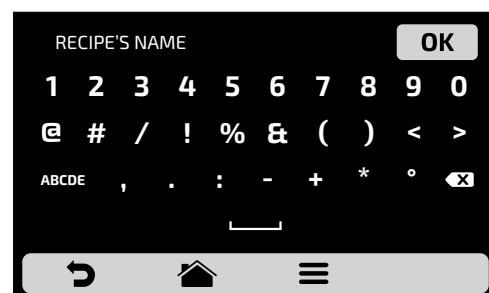

b) Clicking on **123/*** and **ABCDE** the screen will toggle between letters and numbers/special characters.

-  Deletes a character;
-  Space bar;
-  Saves the name and returns to the options.



c) Use  to return to the step editing options.

8.4.2.2. Edit Image.

- Rocket Express has an image gallery that enables the user to change the images of the recipes. Press the icon  .
- Browse through the groups of the image library to select the desired icon or press the button **ABC** to transform the first letter of the recipe name into an icon. As shown in the adjacent example:
- Use  to return to the recipe editing options.

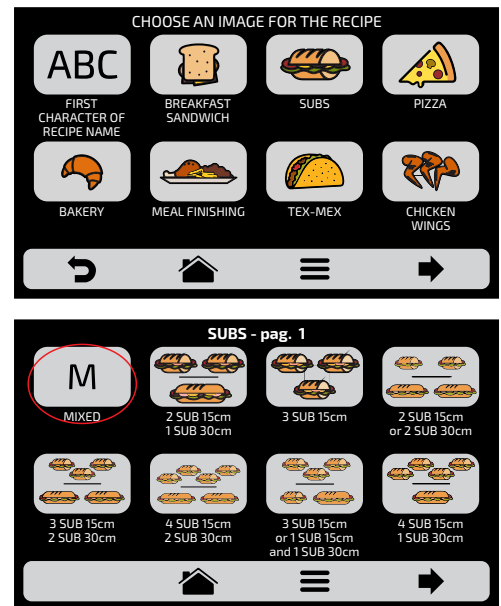

8.4.2.3. Edit Steps.

- Every recipe supports up to 8 steps. The active steps will appear in green on the Edition screen. The other ones will be transparent, according to the opposite image. Click on a step to edit it.
- For each step, it is necessary to inform:
 - Speed of hot air;
 - % of microwaves;
 - % of the lower resistance (infra-red);
 - Temperature
 - Time.
- To change the Speed of Hot Air, Microwaves and Lower Resistance (Infra-red), just swipe the finger over the bar of each parameter or click on the desired location.
- To define the time click on the icon **00:00** . A keyboard will appear on the opposite side, define the desired value and click on OK.
- To define the temperature click on the icon **250°C GROUP1** . A keyboard will appear on the opposite side, define the desired value and click on OK.

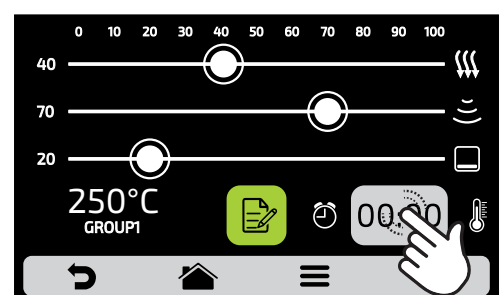
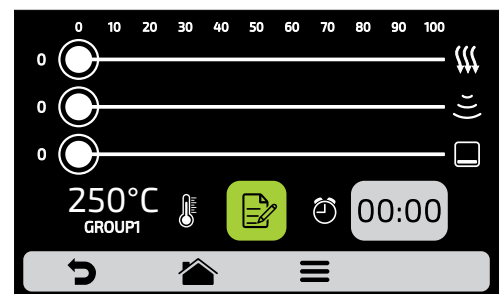
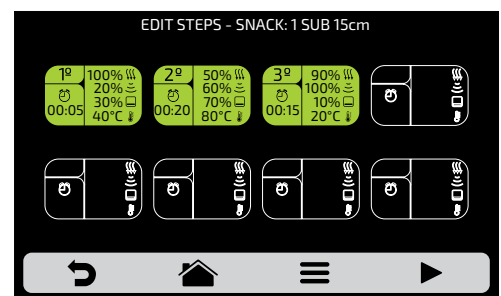

f) Click on the button  to access the options for edition of the step parameters, which are:

g) **Add Information the step**, which will be displayed at the end of the step during the execution of the recipe. Click on the icon .

h) **Activate and deactivate the step:** The recipe only executes active steps. When a step is deactivated, it is not deleted, it only remains hidden. **To delete the step, it is necessary to inform the 00:00 value to the time parameter.**

i) After concluding the edition of a step, use  save and return to the steps screen to edit, create new step, or test the active steps.

j) To test, click on the icon  that is found in the fixed bar on the steps screen. Before proceeding with the test, make sure that there is food inside the chamber.

k) Use  to return to the recipe editing options.

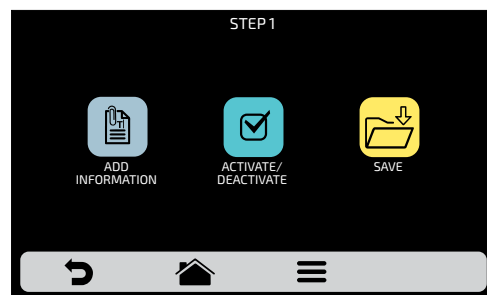



ACTIVE

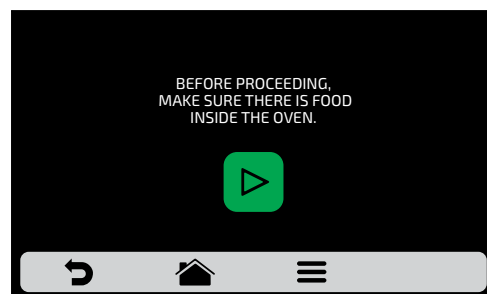
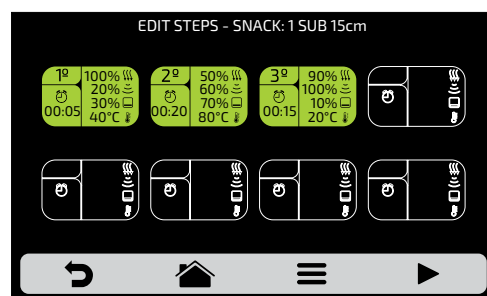

INACTIVE



8.4.2.4. Deleting Recipe.

a) Press  to delete the recipe, press the button  to confirm the exclusion or  to return to the options for recipe edition.

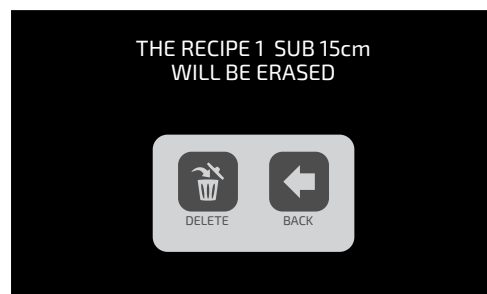



8.4.2.5 Order

a) The Order function , enables to change the sequence in which the groups will appear on the groups screen. This screen is composed by three buttons:



 **Place at the list start:** The recipe is moved to the beginning of the groups list.

 **Place at the list end:** The recipe is moved to the end of the groups list.

 **Choose place in the list:** The operator will be directed to the recipes screen to choose the location he/she wants. according to adjacent example, if the chosen recipe at the beginning of the editing process is '1 SUB 15cm' and the user wishes to place it before '2 SUB 15cm 2 SUB 30cm', just click on the icon of the desired location.

CHOOSE LOCATION IN THE LIST: BEFORE

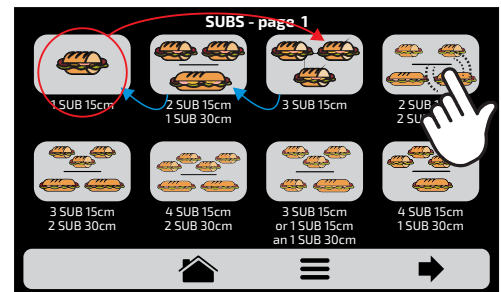

CHOOSE LOCATION IN THE LIST: AFTER

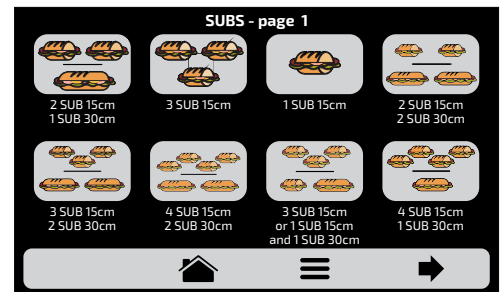

- **Observe by the example that the origin and destination location are not replaced, the software just reorders the recipes.**

b) Use  to return to the recipe editing options.

8.4.2.6. Edit Cook/Brown More.

a) The Cook/Brown More function is defined by recipe, that is, it is not a fixed value for all of them, the user may define the time he/she wishes for each one of the options.



- **Remember that:**
Brown More - Only activates HOT AIR.
Cook More - Activates only the MICROWAVE.
Cook/Brown More - Merges both elements.

b) To define the time, just click on the icon  or on the value location, as the indications on the screen show.

c) Use the number pad to inform the time and click on OK.



d) The Cook/Brown More function may be disabled in the Settings of Edit Accesses (see page 34).

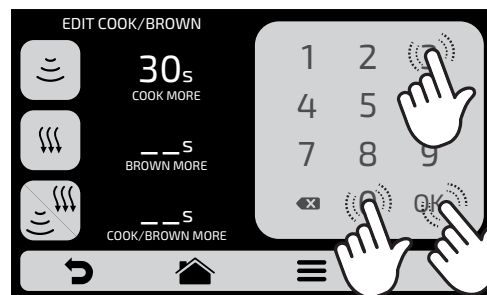
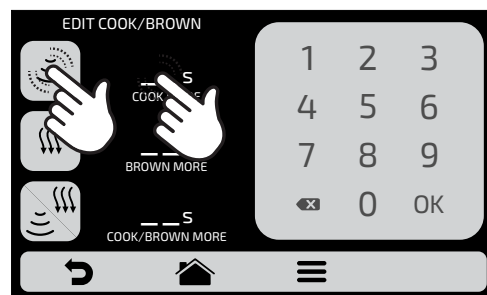

e) Use  to return to the recipe editing options.



8.4.2.7. Add / Remove from Favorites.

a) The Favorites function may be accessed through the options screen in the fixed bar. However, it will be explained in detail on page 36.



b) To add the recipe to the favorites, click on the icon . A small ribbon  will be added in the upper left corner of the recipe icon.

c) To remove the recipe from the favorites, just do the same process. In the recipe edition options screen, the Remove from Favorites icon will appear: , when clicking on it, the ribbon  will disappear from the icon and the recipe will be removed from the Favorites list.

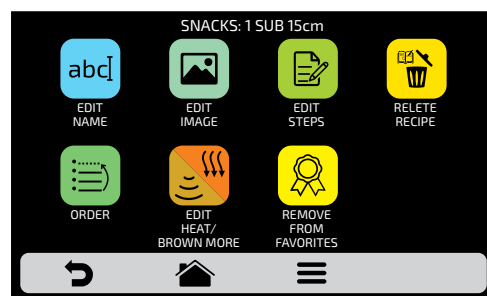
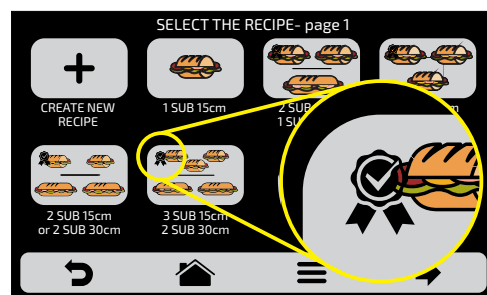
d) Use  to return to the user editing options.



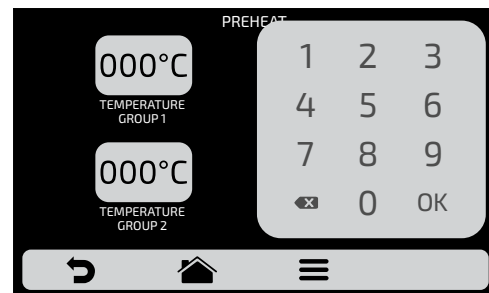

8.4.3 User's Settings: PREHEAT.

- a) The editable parameters in Preheating are:
Temperature Preheating 1.
Temperature Preheating 2.
Preheating Time: Define the time of the stopwatch of the Preheating screen. The purpose is to equalize the temperature inside the chamber when the lower and upper resistances reach the temperature.
- b) To edit the values, click on the icons  and  change the value utilizing the number pad beside.
- c) Use  to return to the user editing options.



8.4.4 User's Settings: USB.

- a) Press the button . The functions available in USB are: Import, Export and Update System.
- b) When selecting one of the functions, the message: *'Insert USB disk and wait for recognition'* will appear.
- c) After the recognition, the user will be taken to the function options previously chosen.
Import: All, Group or Settings.
Export: All, Group or Settings.
System Update.
- d) In case of error, the displayed message will be: There was an error during the Import/Export/Update. Please remove USB disk and restart process.
- e) Use  to return to the user editing options.

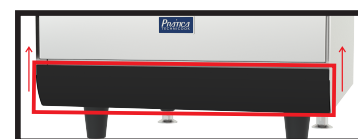

To access the USB port, remove the protector by lifting and pulling forward.

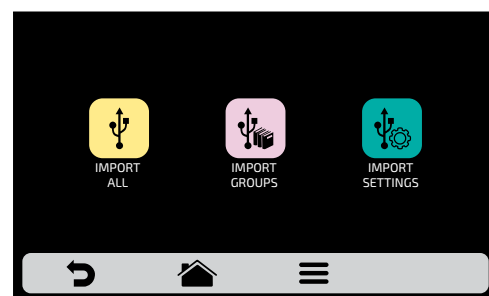
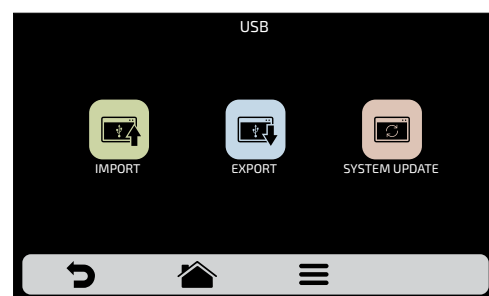
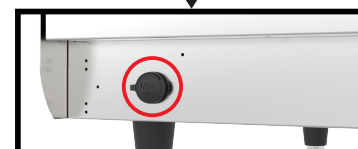

8.4.5 User's Settings: LANGUAGE.

- a) To change the language, just click on the icon  and choose the desired language. English, Spanish, French or Portuguese.

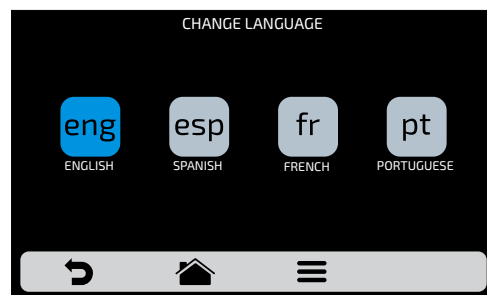

- b) Use  to return to the user editing options.

8.4.6 User's Settings: CURRENT TEMPERATURE.

- a) The Current Temperature screen  is only informative. In it, it is possible to verify the temperature of both resistances: the chamber and lower resistance.

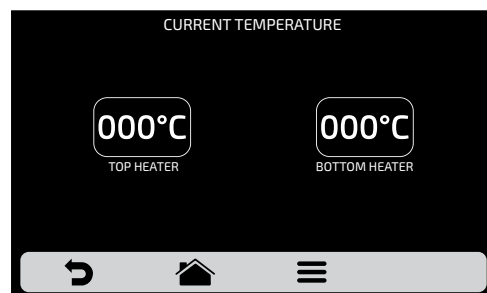



- c) Use  to return to the user editing options.



8.4.7 User's Settings: DATE/TIME ADJUSTMENT.

- a) It is possible to adjust the Date, Time and format it must be presented to the user, respecting the following standards:

European: dd/mm/yyyy Time: 24h Format
American: mm/dd/yyyy 12h Format
ISO: yyyy/mm/dd

- b) Click on  and  to edit, respectively, the date and time.



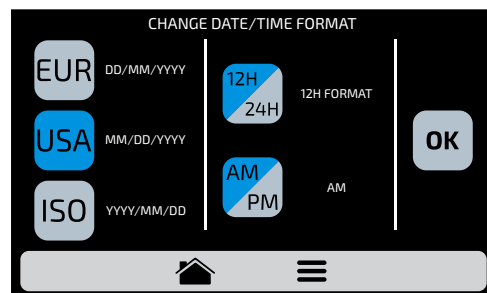

- c) Press  to change the date/time format. The opposite screen will be displayed. Choose the date and time format and click on  to confirm and return to the options.



- d) Use  to return to the user editing options.

8.4.8 User's Settings: CELSIUS/FAHRENHEIT.

- a) Change the temperature format displayed in the oven between Celsius and Fahrenheit, Click on the icon  among the User's Settings, and define the temperature format you wish.
- b) Use  to return to the user editing options.

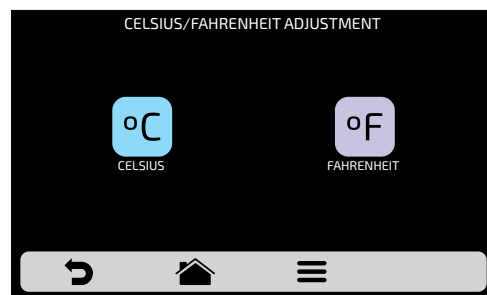

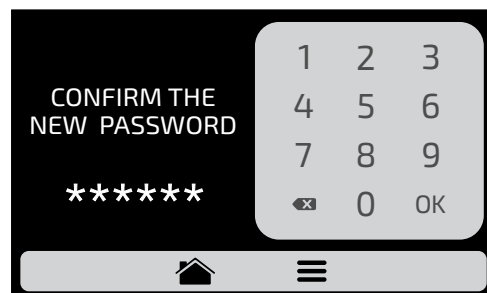
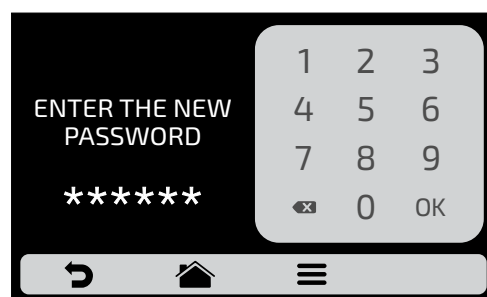

8.4.9 User's Settings: CHANGE PASSWORD.

- a) To change the user's password, just type the new password and then confirm it.
- b) In case you forget the password, contact Technical Support.
- c) Use  to return to the user editing options.



8.4.10 User's Settings: EDIT ACCESS.

- a) Edit Access  corresponds to the function in which you may block functions to which the operators have access. **For example:** If you wish that the Favorites and Manual Cook functions are never accessed by the operators, just click on both of them, which will turn dark gray, indicating that they are locked until the moment you wish to unlock them.
- b) To unlock, just click on the desired functions once more.
- c) Use  to return to the user editing options.

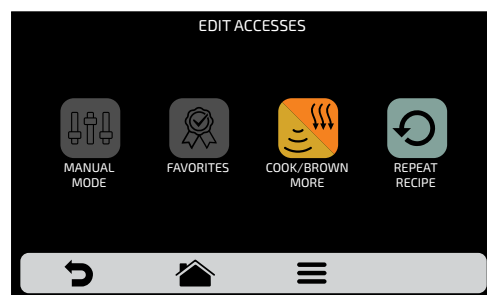
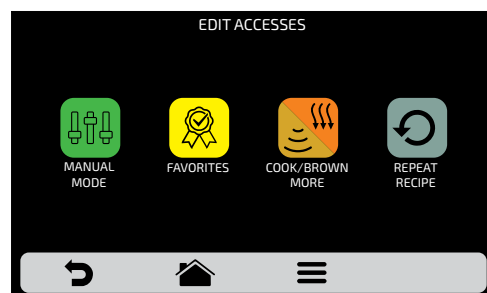

8.4.11 User's Settings: MANUFACTURER'S INFORMATION.

- a) Information on Firmware Version, Serial and Manufacturing Date of the Rocket Express are contained.
- b) Use  to return to the user editing options.

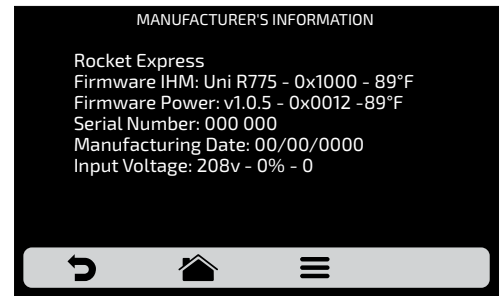

8.4.12 User's Settings: TECH SUPPORT.

- a) In the Tech Support information, you will find all the necessary data to contact *Pratica* to clear out doubts, request repairs or technical visits
- b) Use  to return to the user editing options.





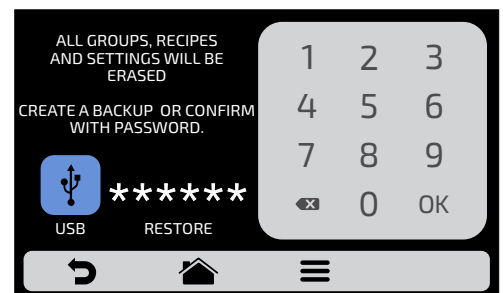

8.4.13 User's Settings: RESTORE FACTORY SETTINGS.

- a) **ATTENTION:** The Restore Factory Settings option will delete all the Groups, Recipes and their Steps, besides the Settings defined by the user. Make sure to create a Backup through USB before proceeding. After inserting the password and touching OK: IT IS NOT POSSIBLE TO RECOVER THE INFORMATION.
- b) Use  to return to the user editing options.





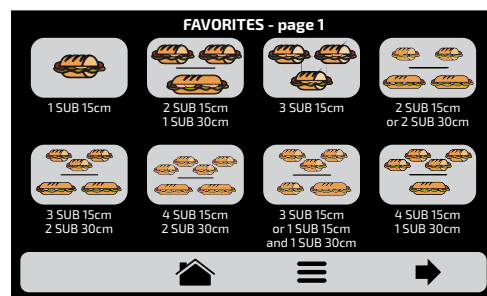
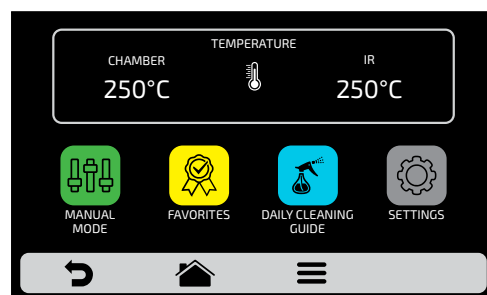

8.5 Favorites

- a) The Favorites functionality works as a shortcut, in which you may allocate the main and most utilized recipes. To access it, just press the Options button  in the fixed menu bar.
- b) After opening the Options screen, touch the icon .
- c) Browse through the recipes using the arrows:  / .
- d) See how to Add or Remove a recipe from the Favorites list on page 31.



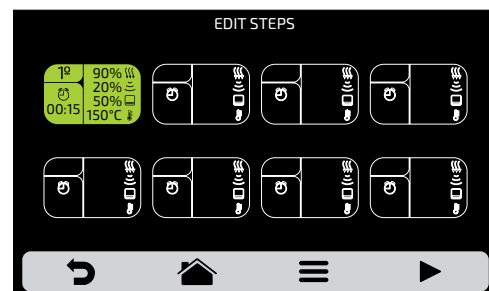
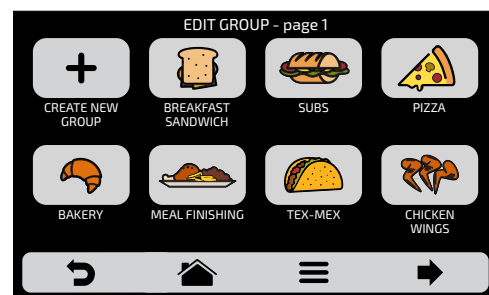
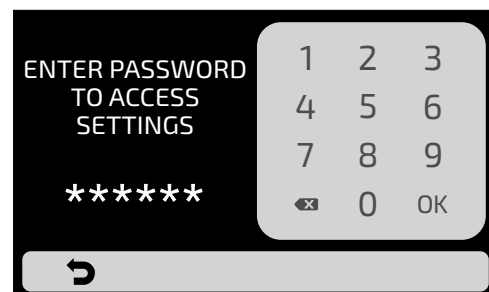
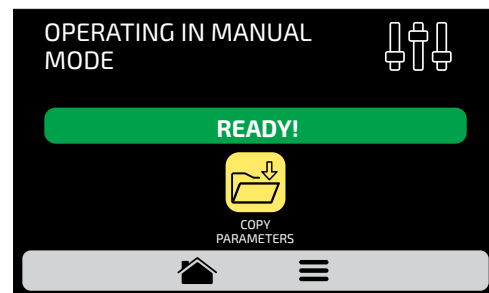
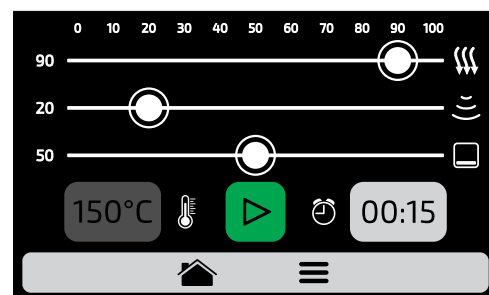
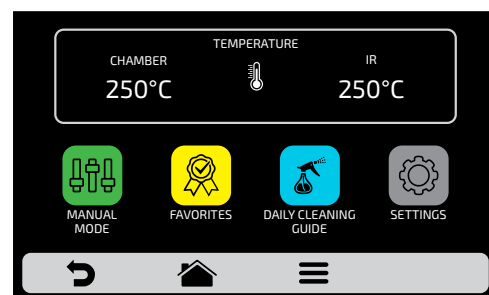

8.6 Manual Mode

- In Manual Mode, it is possible to define the parameters of the step, execute it, and if the result of your test is approved, at the end of the operation, transform it in Recipe.
- To access the Manual Mode, click on the Options button . In the Options screen, touch the icon .
- Define the parameters of Time, Temperature, Speed of Hot Air, Microwaves and of the Bottom Heater (Infra-red).
- Press the button  to start the operation of Manual Mode.
- After the conclusion of the operation, the Copy Parameters icon will be enabled: .
- Copy Parameters enables the user to transport the parameters defined in Manual Mode for the Edition of Groups and Recipes, that is, when click on the icon , it will be necessary to inform the user's access password to the settings.
- After informing the user's password, choose between creating a new group or allocating the transported parameters in a new recipe in an already existent group.
- Define the name of the New Recipe, the Image and choose in which position (step) you wish to allocate the transported information.
- To finalize, if you wish, define the other steps of the recipe.



8.7 Daily Cleaning Guide

a) To help in the sanitation of the Rocket Express, use the Daily Cleaning Guide, access it through the Options screen, click on the Options icon , and then press the button , follow the steps informed on the screen carefully.

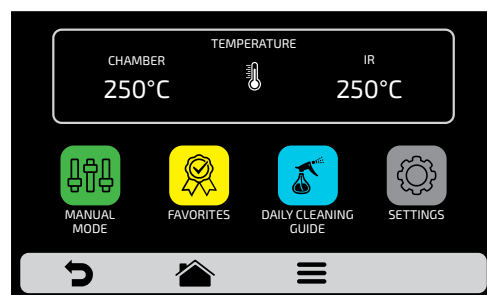

b) **1st**: Open the oven door and wait for the temperature to drop until 150°F. Proceed clicking on the arrow: ➡



c) **2nd**: Remove the cook rack and bottom jet plate and place in the sink. Proceed clicking on the arrow:



d) **3rd**: Apply the Oven Cleaner to the cooking rack and jet plate, allow to stand. Proceed clicking on the arrow: ➡



e) **4th**: Apply the Oven Cleaner to cavity walls and door, let stand for 5 minutes. Proceed clicking on the arrow:



f) **5th**: Use a non-abrasive scrub pad to clean the glass of the waves guide. Proceed clicking on the arrow: ➡



g) **6th**: Use a non-abrasive scrub pad to loosen any stubborn stains if necessary. Proceed clicking on the arrow: ➡

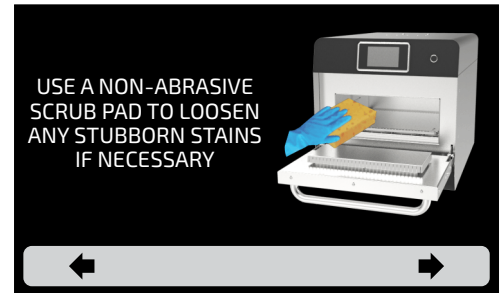

h) **7th**: Wipe/Rinse the cavity with a wet towel removing cleaner and debris. Proceed clicking on the arrow: ➡



i) **8th**: Dry the oven cavity with a towel. Proceed clicking on the arrow: ➡



j) **9th**: Use a non-abrasive scrub pad to loosen any stubborn stains on the cook rack and jet plate if necessary. Proceed clicking on the arrow: ➡

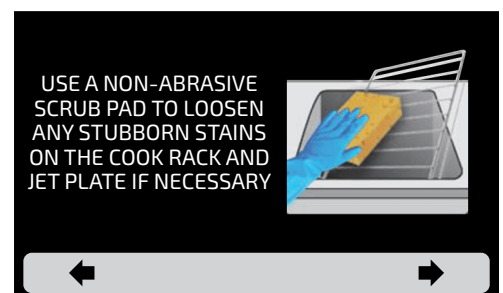

k) **10th**: Check if catalytic converter is in original position. Proceed clicking on the arrow: ➡

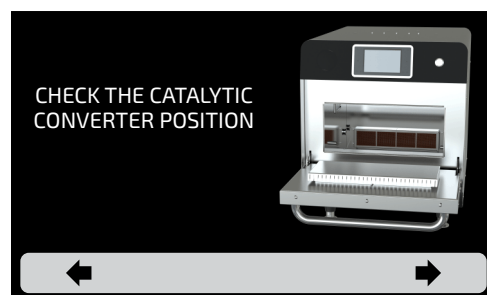

l) **11th**: Rinse, dry and plate, re-install them into the oven cavity. Proceed clicking on the arrow: ➡



m) **12th**: Cleaning complete.



ATTENTION

The equipment sanitation process must be done daily. Failure to follow this guideline may affect the device service life adversely, besides the possibility of resulting in risks as informed in the Safety Instructions contained in this manual (see pages 6 to 9).

8.7.1 Catalytic Converter Cleaning Guide

- a) To have access to catalytic converter, remove the stone, the grid and removable lower tray from the oven.
- b) Then, remove the catalytic converter with an upward movement, as in the image.
- c) Inspect the converter, shake to remove any loose particles and rinse with water. If necessary, to remove stubborn debris, apply Pratica Oven Cleaner, allow to set for 10 minutes, then rinse with water.
- d) Before returning the converter to the oven, remove any excess water. If necessary, shake or tap on a hard surface to confirm.

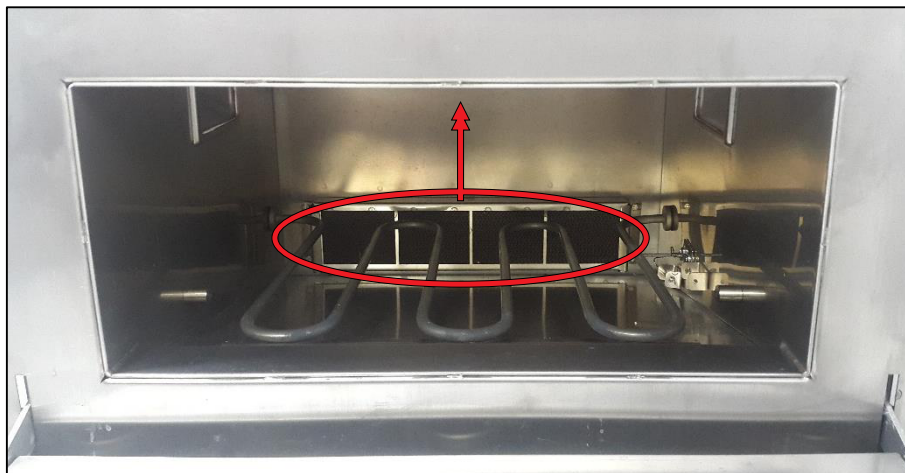

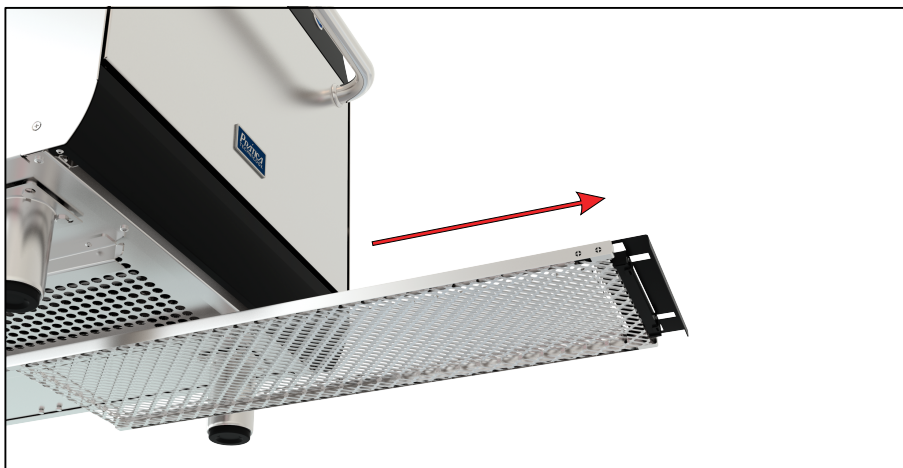

8.7.2 Air Filter Cleaning Guide

- a) Access the Cavity Air Filter from under the oven door
- b) Pull the filter forward to remove from the mounting brackets
- c) Inspect and clean if necessary, with neutral detergents and water
- d) Rinse well with clean water and remove any excess water. If necessary, shake or tap on a hard surface to confirm.
- e) Reinstall the filter by placing into the mounting brackets and pushing back under the oven.



9 ALERTS AND ERRORS: POSSIBLE SOLUTIONS

- a) The Rocket Express was programmed to signal any possible error and alerts that may occur during the operation.
- b) On the Options icon , a yellow signal will appear for alerts () and red for errors (). See how to proceed in each case below.

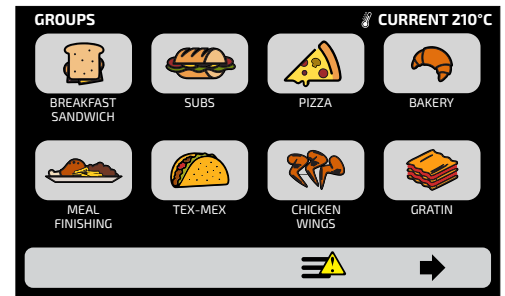

9.1 ALERTS

- a) Click on the Options icon  .
- b) The Options screen will bring, instead of the top and bottom heaters temperatures, a description of the alert. In the adjacent example:

ALERT - CHAMBER SENSOR FAILURE

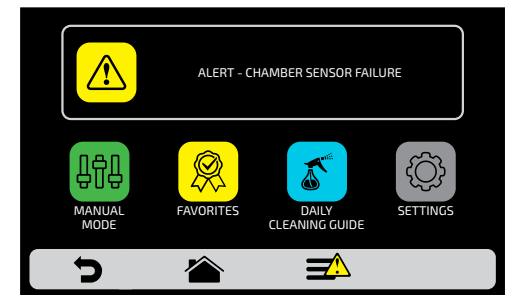

- c) Follow the orientation as described on the screen. In this case, turn off and turn on the oven again using the panel button: 

- d) After turn on the equipment, if the fault persists, call the Technical Support.

9.2 ERRORS

- a) In case of several unsuccessful reset attempts, the alert will become an error, and it will be necessary to contact Technical Assistance.
- b) Refer to the table on the next screen to verify the possible errors and alerts.

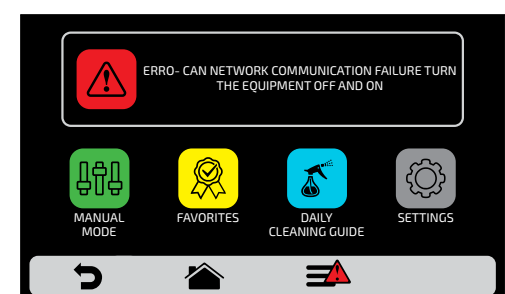

9.3 ALERTS AND ERRORS TABLE

Component	Becomes Alert when:	Becomes Error when:
Inverter	-	more than ten reset attempts
CLMG Low Magnetron Current	-	thirty seconds without reaching the current
Can Network Communication	-	cables disconnected or faulty
Chamber Sensor and IR	only one inactive	both inactive
Panel temperature	from 65 °C to 80 °C	exceeding 80 °C for 10 minutes

You can call our technical assistance to provide feedback, offer suggestions, or get assistance troubleshooting during normal business hours at: +1.214.584.6269.



**PRATICA PRODUCTS, INC.
USA**

424 East Church Street
Lewisville, TX 75057

Phone: +1 214 584-6269

www.praticausa.com

info@praticausa.com

**PRÁTICA KLIMAQUIP IND. E COM. S.A.
BRAZIL**

RODOVIA BR 459, Km 101
37.550-000, Pouso Alegre-MG

Phone: +55 35 3449-1235

pratica@praticabr.com

WWW.PRATICABR.COM

CODE

032576

ROCKET EXPRESS
INSTALLATION AND OPERATIONAL MANUAL
MARCH 2019 - REVISION 05