

SERVER.

• E S S E N T I A L S •

WIRESWISE® ORGANIZERS

**MODEL:
WW**

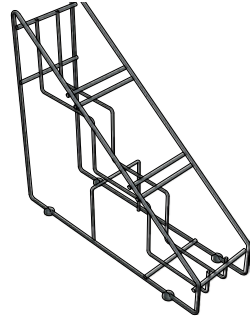
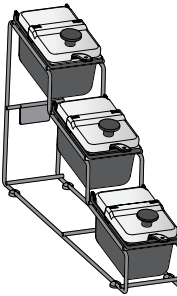

Thank You

for purchasing from our WireWise® line of space saving tiered racking. The lightweight yet durable wire-frame allows you to hold more product in a small footprint for an operationally efficient use of space.

SMALL FOOTPRINT. SAVE SPACE.

BEFORE USE...

Make sure the four RUBBER FEET are in place on the bottom of the wire rack.

The non-skid feet on your WireWise™ keep it from sliding and prevent scratches on your counter tops.

Need a replacement foot?
Order part number 88612

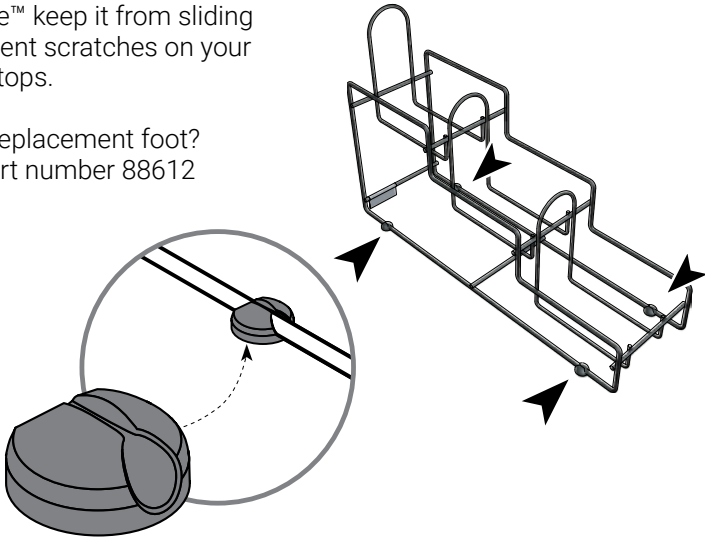

CLEANING

CLEAN with dishwashing detergent and hot water.

RINSE fully with clear water.

SANITIZE all parts according to local sanitization requirements. All parts in contact with food must be sanitized.

AIR DRY all parts fully.

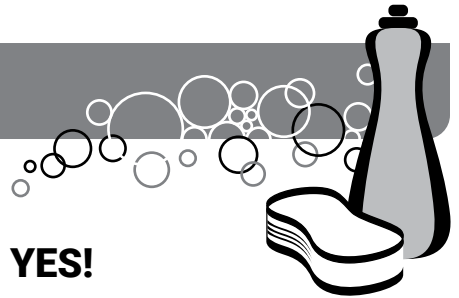

YES!

Use dishwashing soap and hot water

The WireWise™ is finished with powder coated paint. Treat it with care by washing only with a non-abrasive cleaner.

WIRESWISE® ORGANIZERS

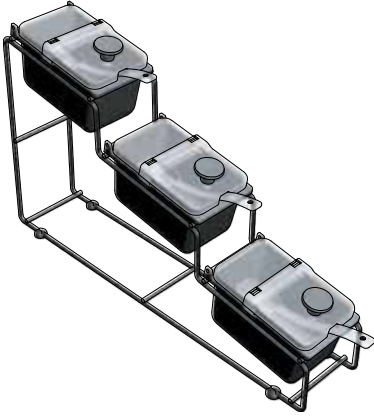

88711

Includes (3) each combos
of 1/9-jars, lids & spoons

1/9 SIZE LID	87253
1/9 SIZE JAR, 3.5" DEEP, BLACK	87202
SPOON, 1/2 OZ	85156

WIRESWISE® ORGANIZERS

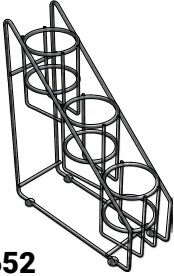

88652

Holds (3) round bottles
up to 1 liter each

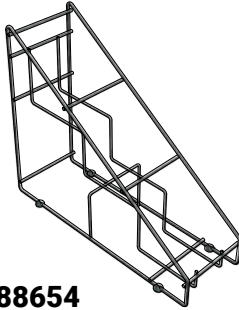

88654

Holds (3) 1 gal jugs

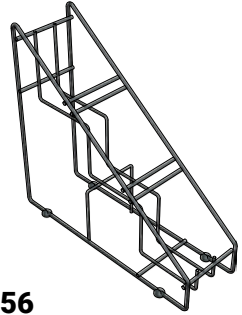

88656

Holds (3) 64 oz square jugs

WIRESWISE™ LINK KIT

Clip two organizers together
to form one.

Order 4 pk kit 88716

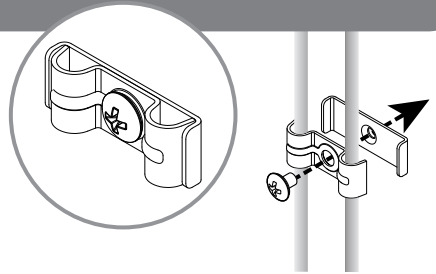

NEED HELP?

Server Products Inc.
3601 Pleasant Hill Road
Richfield, WI 53076 USA

Chat with us!

spsales@server-products.com

262.628.5600 | 800.558.8722

Please be prepared with your **Model, P/N** and
Series located on the lid or base of the unit.

Example:

MODEL	NSF®	SERIES
XXXX		##X ##X
P/N		
#####		

SERVER
INTELLIGENT BY DESIGN™