



Quality Refrigeration

Quick Start Guide

Instructions for the installation, use and care of:

R/A Series

G Series

TE Series/ TU Series/ TS Series

1. RECEIPT & SUPPORT INSTALLATION

You should carefully inspect your Traulsen unit for damage during delivery. If damage is detected, you should save all the crating materials and make note on the carrier's Bill Of Lading describing the damage. A freight claim should be filed within 5 days.

After uncrating the unit, select a level location for final placement. Install the casters (or optional leg supports) as shown below.

Supports: "Stem" type casters (standard), "Stem" type legs (optional), "Plate" type casters (TE/TS/TU)

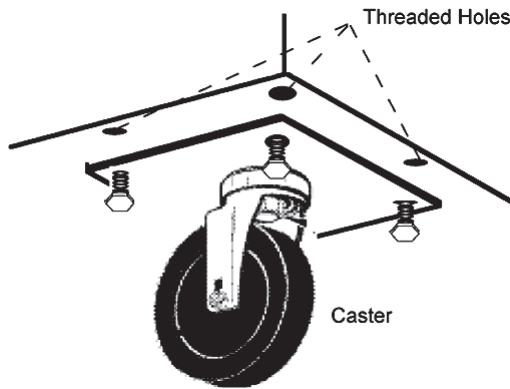

Stem Type Caster

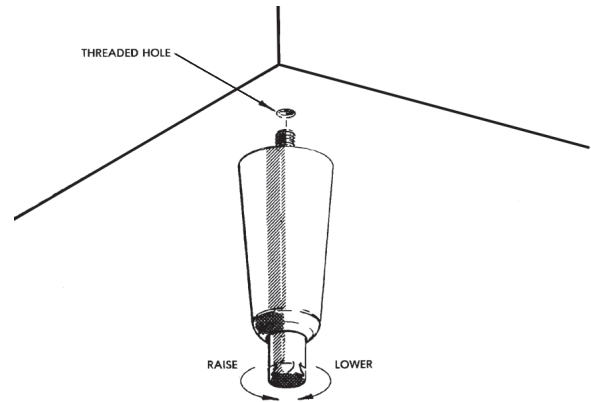

Stem Type Leg

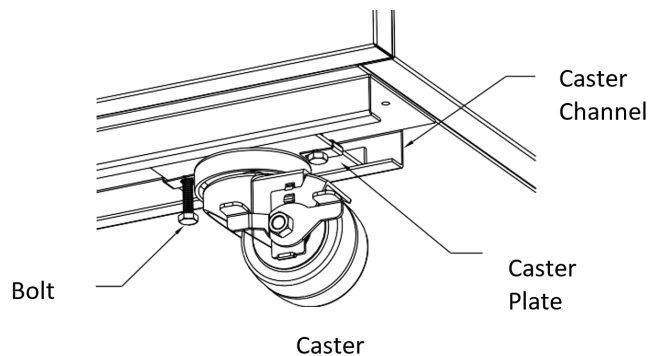

Plate Type Caster

1. RECEIPT & SUPPORT INSTALLATION (continued)

⚠ WARNING

Some models may use R-290 (Propane) as a refrigerant. If flammable refrigerant is present, follow instructions as labeled on the unit. Proper care must be taken to avoid any damage to refrigeration system including refrigerant tubing, condenser, evaporator coils during handling, moving, installation and cleaning as it may cause risk of fire or explosion. If damaged, unit must be moved to well ventilated area away from any sources of ignition.

Further service and repair must be performed by qualified refrigeration technicians familiar with applicable safety standards for flammable refrigerants. Technicians must use appropriate personal protective equipment and follow applicable safety precautions to avoid risk of fire or explosion.

All models (except compact undercounter) should be installed to allow at least 12" of clear space above the unit. In all cases, the louvers must be free of any obstruction which could prevent proper air-flow.

Most units are supplied with a cord and plug, which can simply be plugged into a dedicated appropriately sized outlet. For those requiring hard-wiring directly to the power supply, this should be done by a qualified electrician only.

NOTE: Some models require provision of a bottom mounted condensate evaporator. Follow instructions provided with part, along with the figure below for installation.

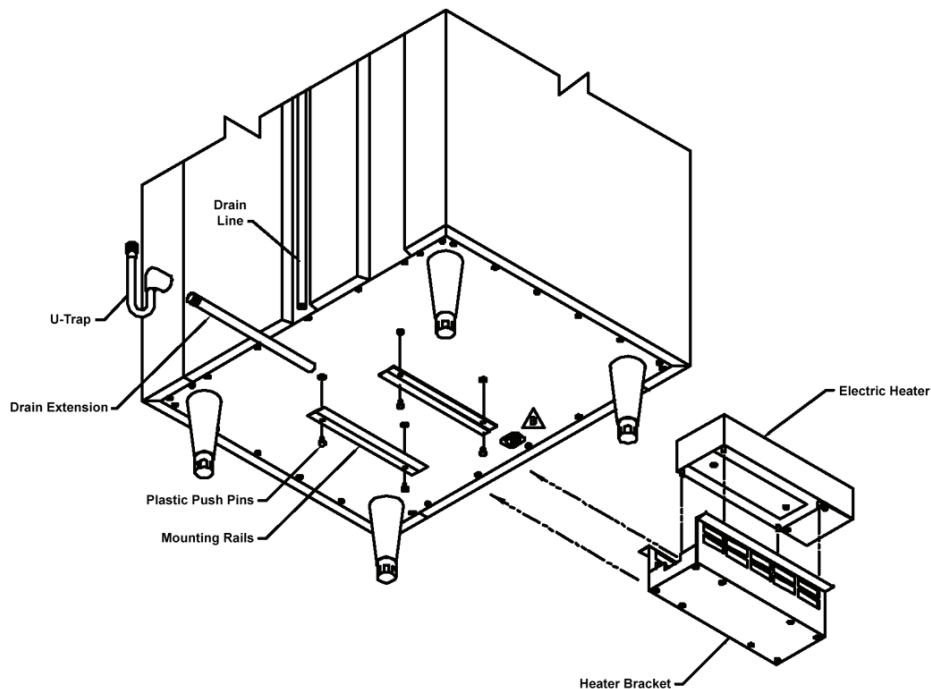

Bottom Mounted Condensate Evaporator

2. R/A/G/TE/TU/TS SERIES CONTROL OVERVIEW

Most Traulsen equipment is plug and play. However, once power is supplied to the unit, you may make minor adjustments to your Traulsen unit. **NOTE:** Models in the TE/TU/TS Series may have an alternate display shown in Section 3.

2A - CONTROLLER DISPLAY – R/A/G/TE/TU/TS SERIES

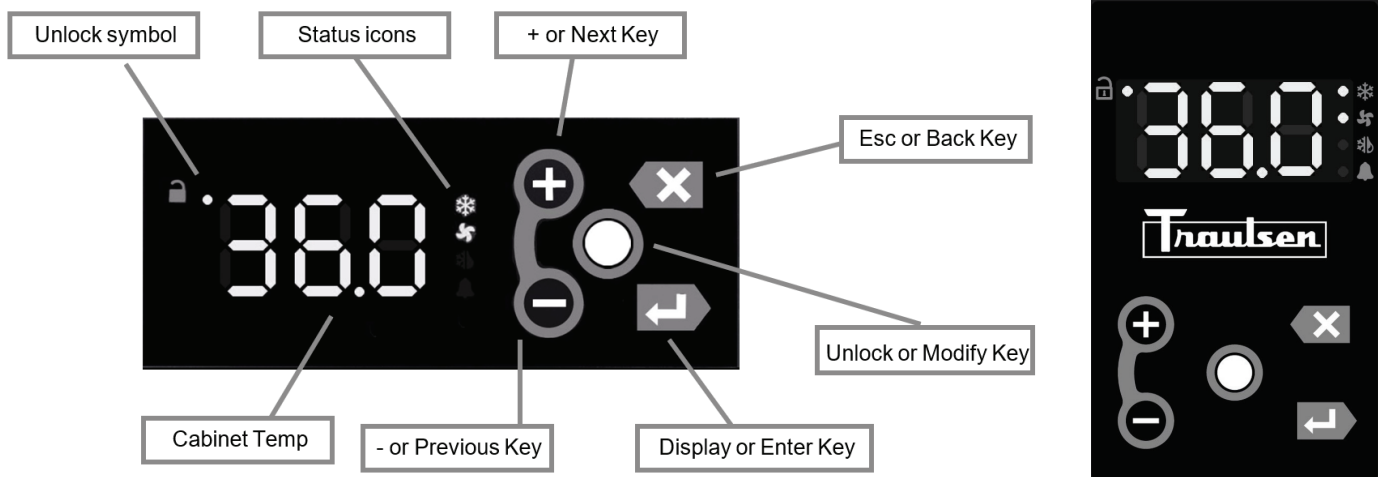

(Display can be horizontal or vertical)

2B - UNDERSTANDING THE DISPLAY

DISPLAY SYMBOL	SYMBOL DESCRIPTION
	Temperature Reading/Settings
	Keypad Unlocked
	Keypad Locked
	Compressor On
	Fan On
	Defrost
	Alarm/Door Open

On the **Left Side and/or Top** of the display, there are colored LEDs for showing the temperature, status of the compressor, fans, lock/unlock status, etc.

DISPLAY SYMBOL	SYMBOL DESCRIPTION
	Unlock/Modify Key
	Minus (-)/Previous Key
	Plus (+)/Next Key
	Enter/Display Key
	Esc/Back/Cancel Key

On the **Right Side of and/or Under** the display, there are 5 capacitive touch buttons for managing the operation of the unit.

2C - UNLOCKING THE KEYPAD

DISPLAY SYMBOL	SYMBOL DESCRIPTION
	Plus (+)/Next Key
	Minus (-)/Previous Key
	Enter/Display Key
	Esc/Back/Cancel Key

Normally, the keypad is locked to prevent inadvertent changes to settings. The **Unlock Key** is a white dot on the right side of and/or under the display, centered between the other 4 keys. Press the Unlock key twice within a second in order to unlock the keypad (think “tap-tap”). The **Keypad Unlocked LED** will turn on to indicate the keypad is now live. The keypad will stay unlocked until 3 minutes of inactivity have passed, at which time it will automatically lock the keypad. There are 2 operations the user can perform without having to enter a password:

- Change the temperature setpoint
- Initiate a defrost operation

2. R/A/G/TE/TU/TS SERIES CONTROL OVERVIEW (continued)



2D - CHANGE THE TEMPERATURE SETPOINT

The setpoint to the unit can be changed simply by pressing the **Plus or Minus Key**. There will be a slight delay at first to prevent an accidental change, so it will be necessary to hold the key for 3-4 seconds until the value starts to flash. The flashing value indicates the setting is being modified. To raise the setpoint, press the **Plus Key** to increment to the setpoint you want. Similarly, press the **Minus Key** to lower the setpoint. When the desired value is reached, press the **Enter/Display Key** to lock in the value. Pressing the **Esc Key** will abort the process and keep the original setpoint. The keypad must be unlocked in order to change the setpoint using the shortcut method.

2E - INITIATE A DEFROST OPERATION



UNIT	DEFROST INTERVAL
Upright Ref	8
Upright Frz	4
Compacts	6

Defrost is a necessary operation to remove frost that builds up on the evaporator coil and reduces air flow within the cabinet. Normally this is done automatically based on a time interval and the ambient conditions of the environment. A special sensor is used to measure the humidity in the air to adjust the defrost interval depending upon humidity levels. The nominal defrost intervals are shown in table on the left.

DISPLAY SYMBOL	SYMBOL DESCRIPTION
	Minus (-)/Previous Key
	Esc/Back/Cancel Key
	Defrost

To manually defrost the unit, press the **Minus Key** and the **Esc Key** simultaneously and hold for 5 seconds. Units equipped with an LED temperature display will indicate when a defrost cycle is in process. The **Defrost Symbol** will illuminate letting you know defrost is in effect. Depending on the settings, the unit may also show “DEF”.





2F - HOT FOODS CABINETS - UNLOCKING THE KEYPAD

DISPLAY SYMBOL	SYMBOL DESCRIPTION
	Unlock/Modify Key
	Keypad Unlocked

Normally, the keypad is locked to prevent inadvertent changes to settings. The **Unlock Key** is a white dot on the right side of and/or under the display, centered between the other 4 keys. Press the **Unlock Key** twice within a second in order to unlock the keypad (think “tap-tap”). The **Keypad Unlocked LED** will turn on to indicate the keypad is now live. The keypad will stay unlocked until 3 minutes of inactivity have passed, at which time it will automatically lock the keypad. There are 2 operations the user can perform without having to enter a password:

- Change the temperature setpoint
- Turn the heaters off



2G - HOT FOODS CABINETS - CHANGE THE TEMPERATURE SETPOINT

DISPLAY SYMBOL	SYMBOL DESCRIPTION
	Plus (+)/Next Key
	Minus (-)/Previous Key
	Enter/Display Key
	Esc/Back/Cancel Key

The setpoint to the unit can be changed simply by pressing the **Plus or Minus Key**. There will be a slight delay at first to prevent an accidental change, so it will be necessary to hold the key for 3-4 seconds until the value starts to flash. The flashing value indicates the setting is being modified. To raise the setpoint, press the **Plus Key** to increment to the setpoint you want. Similarly, press the **Minus Key** to lower the setpoint. When the desired value is reached, press the **Enter Key** to lock in the value. Pressing the **Esc Key** will abort the process and keep the original setpoint. The keypad must be unlocked in order to change the setpoint using the shortcut method.

2. R/A/G/TE/TU/TS SERIES CONTROL OVERVIEW (continued)

2H - HOT FOODS CABINETS - TURN THE HEATERS OFF







DISPLAY SYMBOL	SYMBOL DESCRIPTION
	Unlock/Modify Key
	Keypad Unlocked

The keypad must be unlocked in order to de-activate the heaters. Press the **Unlock key** twice within a second in order to unlock the keypad. The **Keypad Unlocked LED** will turn on to indicate the keypad is active. To turn the unit off, press and hold the **Unlock Key** until the display shows "OFF". To turn the unit ON, press the **Unlock Key** until the display shows the temperature.

3. TE/TU/TS SERIES ALTERNATE CONTROL OVERVIEW

Your new Traulsen unit is equipped with a digital control, which precisely regulates operation. It is supplied from the factory completely ready for use.



-  Thermostat output
-  Fan output
-  Defrost output
-  Activation of 2nd parameter set
-  Alarm
-  Manual activation / Increase button
-  Exit / Stand-by button

3A - INFORMATION MENU





The information available in this menu is:

<i>t1</i>	Instant probe 1 temperature
<i>t2</i>	* Instant probe 2 temperature
<i>cmd</i> **	Compressor working weeks

* displayed only if enabled (see Configuration Parameters in section 3D)

** displayed only if ACC > 0

Access to menu and information displayed:

- Press and immediately release button .
- With button  or  select the data to be displayed.
- Press button  to display value.
- To exit from the menu, press button  or wait for 10 seconds.

Initiate Stand-By:

Keeping the button  pressed for 3 seconds allows the controller to be put on a standby or output control to be resumed (with **SB=YES** only).





Locking the Keypad:

The keypad lock avoids undesired, potentially dangerous operations, which might be attempted when the controller is operating in a public place. In the INFO menu, set parameter **LOC** = YES to inhibit all functions of the buttons. To resume normal operation of keypad, adjust setting so that **LOC** = NO.

3. TE/TU/TS SERIES ALTERNATE CONTROL OVERVIEW (continued)

3B - ADJUSTING CABINET SETPOINT

Setpoint display and modification:

- Press button  for at least a half second to display the setpoint value.
- While keeping the  button pressed, use button  or  to set the desired value (adjustment is within the minimum **SPL** and the maximum **SPH** limit).
- When button  is released, the new value is stored.

3C - INITIATING A DEFROST

Automatic defrost:

Defrost starts automatically as soon as the time set with parameter **DFT** has elapsed.

- Timed defrost: With **DFM** = TIM defrosts take place at regular intervals when the timer reaches the value of **DFT**. For example, with **DFM** = TIM and **DFT** = 36, a defrost will take place every 6 hours.
- Optimized defrost: With **DFM** = FRO the timer is only increased when the conditions occur for frost to form on the evaporator, until the time set with parameter **DFT** is matched. If the evaporator works at 0°F, defrost frequency depends on the thermal load and climatic conditions. With setpoints much lower than 0°F, defrost frequency mainly depends on the refrigerator operating time.
- Defrost time count backup: At the power-up, if **DFB** = YES, the defrost timer resumes the time count from where it was left off before the power interruption. Vice versa, with **DFB** = NO, the time count re-starts from 0. In stand-by, the accumulated time count is frozen.

Manual or remote defrost start:

It's possible to manually start a defrost, by pressing button  for 2 seconds.

Defrost type. Once defrost has started, Compressor and Defrost outputs are controlled according to parameter **DTY**. If **FID** = YES, the evaporator fans are active during defrost.

Defrost termination. The actual defrost duration is influenced by a series of parameters.

- Time termination: **T2** = NO and **T3** different from 2EU: the evaporator temperature is not monitored and defrost will last as long as time **DTO**.
- Temperature monitoring of one evaporator: **T2** = YES and **T3** different from 2EU. In this case, if the sensor **T2** measures the temperature **DLI** before the time **DTO** elapses, defrost will be terminated in advance.











Resuming thermostatic cycle:

When defrost is over, if **DRN** is greater than 0, all outputs will remain off for **DRN** minutes, in order for the ice to melt completely and the resulting water to drain. Moreover, if probe **T2** is active (**T2** = YES), the fans will re-start when the evaporator gets to a temperature lower than **FDD**; Vice versa, if probe **T2** is not active (**T2** = NO) or after defrost has come to an end, such condition does not occur by end of the time **FTO**, after **FTO** minutes have elapsed the fans will be switched on anyway.

Caution: If **DFM** = NON or **C-H** = HEA all defrost functions are inhibited; if **DFT** = 0, automatic defrost functions are excluded.

3D - CONFIGURATION PARAMETERS

Parameter Configuration:

- To get access to the parameter configuration menu, press button  and  for 5 seconds.
- With button  or  select the parameter to be modified.
- Press button  to display the value.
- By keeping button  pressed, use button  or  to set the desired value.
- When button  is released, the newly programmed value is stored and the following parameter is displayed.
- To exit from the setup, press button  or wait for 30 seconds.

3. TE/TU/TS SERIES ALTERNATE CONTROL OVERVIEW (continued)

3E - OPERATION DISPLAY INDICATORS

During normal operation, the display shows either the temperature measured or one of the following indications:

dEF	Defrost in progress
oFF	Controller in stand-by
cL	Condenser clean warning
do	Door open alarm
E1	Probe T1 failure
E2	Probe T2 failure
E3	Probe T3 failure

4. GENERAL CARE

⚠ WARNING

Disconnect electrical power supply before cleaning any parts of the unit. All Traulsen equipment should be cleaned only with warm water, mild soap and a soft cloth. Apply with a dampened cloth and wipe in the direction of the metal grain.

Avoid the use of strong detergents and gritty, abrasive cleaners as they may tend to mar and scratch the surface. Do not use cleansers containing chlorine, this may promote metal corrosion.

Care should also be taken to avoid splashing the unit with water, containing chlorinated cleansers, when mopping the floor around the unit. For stubborn odor spills, use baking soda and water (mixed to a 1 TBSP baking soda to 1 pint water ratio).

5. ADJUSTING THE SHELVES

Shelves Mounted on Pins

First select the desired location and remove the white plastic covers in the interior back and sides by rotating them counter-clockwise. Install the pins in the desired location by rotating them clockwise. Make sure the pin is securely tightened down. Do not over tighten. Slide the shelf into its new position, and replace the white plastic covers into the holes vacated by the shelf pins.

Shelves Mounted on Clips & Pilasters

Shelves and shelf clips are shipped with the unit. For each shelf, insert four (4) shelf clips into the pilaster slots at the same height. The shelf clips have a small projection on top which holds the shelf in position and prevents it from slipping forward. After installing shelf clips on pilasters, place shelves on clips.

6. CLEANING THE CONDENSER

⚠ WARNING

Disconnect electrical power supply before cleaning any parts of the unit.

This is the single most important thing you can do to promote long, efficient equipment life. For all Upright Cabinets, remove the two bottom screws securing the louver panel, then pivot this upwards allowing full access to the front facing condenser. For all TE Series, TU Series & TS Series, place hands under the louver panel and pull out and up to get louver panel off bracket of the unit. Contact factory technical assistance at 800-825-8220 for all Compact Undercounter and Compact Prep-Table.

Vacuum or brush any dirt, lint or dust from the finned condenser coil, around the compressor and other cooling system parts as indicated. If significant dirt is clogging the condenser fins, use compressed air to blow this clear. When finished reverse the louver removal process as instructed above.

6. CLEANING THE CONDENSER (continued)

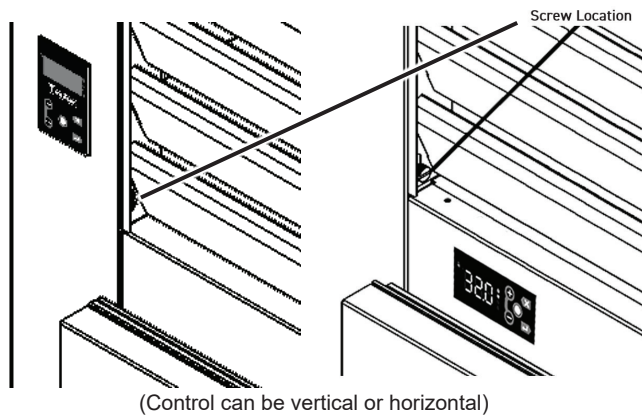

Upright Units Louver

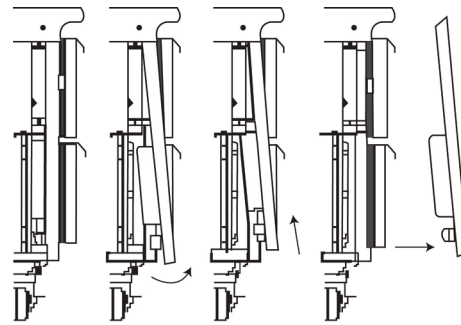

TE/TU/TS Series Louver

7. TROUBLE SHOOTING

⚠ WARNING

Some models may use R-290 (Propane) as a refrigerant. Service and repair must be performed by qualified refrigeration technicians familiar with applicable safety standards for flammable refrigerants. Technicians must use appropriate personal protective equipment and follow applicable safety precautions to avoid risk of fire or explosion. Service and repair must be performed in well ventilated and unconfined area, away from any ignition sources. All system components must be replaced with like components. Factory recommends to use exact make and models to assure the consistent performance and to minimize the risk of possible ignition due to incorrect parts. In case of uncertainty or parts unavailability, contact Traulsen technical assistance at 800-825-8220.

PROBLEM	POSSIBLE SOLUTION
1. Condensing unit fails to start.	a. Check if cord & plug has been disconnected.
2. Condensing unit operates for prolonged periods or continuously.	a. Are door(s) or drawer(s) closing properly? b. Dirty condenser or filter. Clean properly. c. Evaporator coils iced. Needs to defrost.
3. Food Compartment is too warm.	a. Check door(s) or drawer(s) and gasket(s) for proper seal. b. Check if a large quantity of warm food was recently added or the door was kept open for a long period of time. c. Control setting is too high, readjust.
4. Food Compartment is too cold.	a. Check if a large quantity of very cold or frozen food has recently been added. Allow adequate time for the cabinet to recover its normal operating temperature. b. Adjust the control to warmer setting, readjust.
5. Condensation on exterior surface.	a. Check door(s) or drawer(s) alignment & gaskets for proper seal. b. Condensation on the exterior surface of the unit is perfectly normal during periods of high humidity. c. Check perimeter heat setting and increase setting if <100.

8. SERVICE/WARRANTY INFORMATION:

To speak to service support for Traulsen units please contact our Fort Worth, TX facility by phone at 800-825-8220 or by fax to 817-740-6748 (parts) or 817-740-6757 (service).

Traulsen		4401 Blue Mound Rd. Ft. Worth, TX 76106 800-825-8220	
MODEL: MODELO: MODELE:	RDT232W/UF-FHS		
S/N:	T2536AA14		
 <small>SCALE FOR SERVICE INFO</small>			
REFRIGERANT / REFRIGÉRANTE / RÉFRIGÉRANT			
SY11 (REFM):	R-134a	8.4oz	238.1 g (238.1 g)
Hi Press. (PRESH):	500psi 3.45 MPa (3.45 Mpa)		
Lo Press. (PRESL):	250 psi 1.72 Mpa (1.72 Mpa)		
SY52 (REFAF):	R-404a	12.5oz	354.4g (354.4g)
Hi Press. (PRESH):	500psi 3.45MPa (3.45MPa)		
Lo Press. (PRESL):	250psi 1.72Mpa (1.72Mpa)		
Input Power (ELIN) - FOR INDOOR USE ONLY			
115-208/230V ~ 60Hz 8.0A (8.0A)			
(Symbol 1) (Alt Safety / Other 1)	(Symbol 2) (Alt. San / Other 2)	(Symbol 3) (Alt. En. / Other 3)	(Symbol 4) (WEEE)
(Symbol 5) (Safety)	(Symbol 6) (Sanitation)	(Symbol 7) (Energy)	(Symbol 8) (Customer QR Code / Other 4)
Device/Part Number: PartNum		(U/NSF Notes)	
COMPONENTS / COMPOSANTS / COMPONENTES			
COMP AMPS:	EVAP FAN AMPS:		
COND FAN AMPS:	LIGHT WATTS:		
DEF HTR AMPS:	CTRL AMPS:		
DOOR HTR AMPS:	MIN AMPS:		
MAX AMPS:			
<small>370-60297-00 REV. A 11/20/14</small>			

□ Model Number
□ Serial Number

Note: When calling for service support, please make sure you have model and serial number of unit available.

Please visit our website at www.traulsen.com for additional service, literature and parts information. From our home page click on the **SERVICE** tab, and select one of the following:

- SERVICE FINDER
- OWNER'S MANUALS
- PARTS PRICING
- SERVICE & PARTS MANUALS
- WARRANTY REGISTRATION

WARRANTY REGISTRATION

The warranties for your new Traulsen unit may be registered with us by contacting our Fort Worth, TX facility directly by phone at 800-825-8220.

HOURS OF OPERATION:

Monday thru Friday 7:30 AM - 4:30 PM CST



Quality Refrigeration

Traulsen

4401 Blue Mound Road Fort Worth, TX 76106

Phone (800) 825-8220

Service Fax (817) 740 6757

www.traulsen.com