

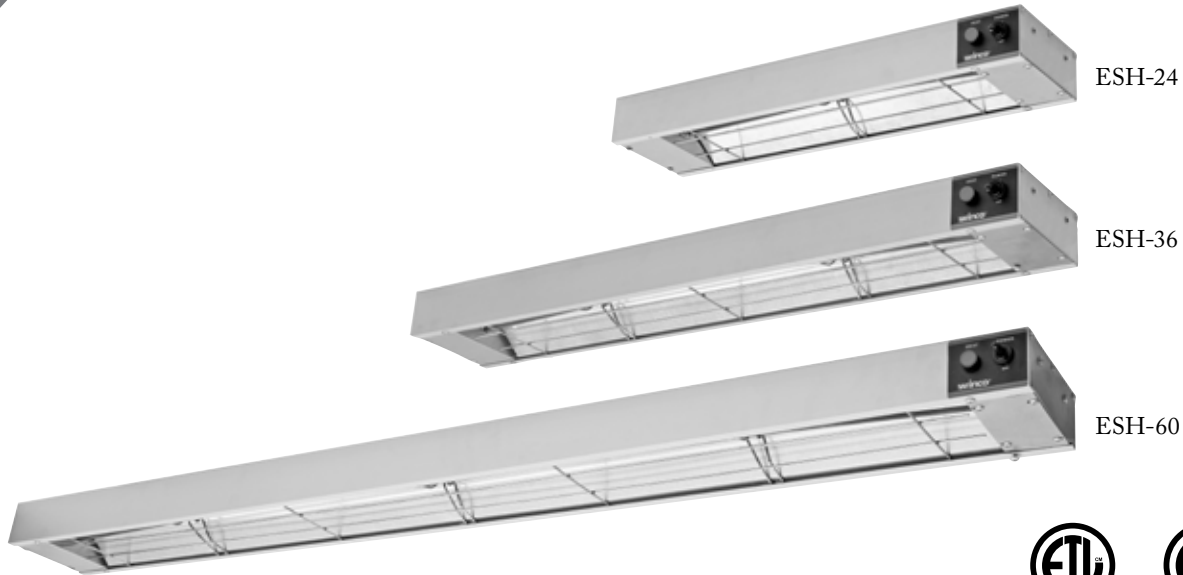

COMMERCIAL INFRARED STRIP HEATER

Operating Instruction Manual



ESH-48 & ESH-72 Not Shown



Model	Voltage	Power	Amperage	Dimensions		
				Length	Depth	Height
ESH-24	120V ~ 60Hz	500W	4.2A	24"	6"	2.5"
ESH-36		850W	7A	36"		
ESH-48		1100W	9.1A	48"		
ESH-60		1400W	11.5A	60"		
ESH-72		1750W	14.5A	72"		

Chains for hanging are included. Undermount bracket is also included with each item for wall-mounting.

Available separately:

- Undermount Bracket and Screws (ESH-UB)
- Hanging Chains (ESH-CH)

Accessories:

Model	Description
ESH-CH	Hanging Chain
ESH-UB	Undermount Bracket and Screws

BEFORE OPERATING ANY EQUIPMENT, READ AND FAMILIARIZE YOURSELF WITH THESE USE AND SAFETY INSTRUCTIONS

Congratulations on your purchase of this WINCO® commercial infrared strip heater. WINCO takes pride in the quality of its products. When used as intended and with proper care and maintenance, you will experience years of reliable operation from this equipment. To ensure best results, it is important that you read and follow the instructions in this manual carefully. **It's important to save these instructions for future reference.**

Commercial Infrared Strip Heater

Important For Future Reference

Please complete this information and retain this manual for the life of the product. For Warranty Service and/or parts, this information is required. Please see Page 10 for More information on your Warranty and how to register.

ESH- Model Number	ESH Serial Number	Date Purchased
-----------------------------	-----------------------------	----------------



WARNING: IMPROPER INSTALLATION, ADJUSTMENT, ALTERATION, SERVICE OR MAINTENANCE CAN CAUSE PROPERTY DAMAGE, INJURY, OR DEATH. READ THE INSTALLATION, OPERATION, AND MAINTENANCE INSTRUCTIONS THOROUGHLY BEFORE INSTALLING OR SERVICING THIS EQUIPMENT.

AVERTISSEMENT: TOUTE INSTALLATION, RÉGLAGE, MODIFICATION, RÉPARATION OU ENTRETIEN INCORRECT PEUT OCCASIONNER DES DOMMAGES MATÉRIELS, DES BLESSURES GRAVES OU LA MORT. LIRE LES INTRUCTIONS D'INSTALLATION, D'UTILISATION ET D'ENTRETIEN ATTENTIVEMENT AVANT D'INSTALLER OU DE RÉPARER CET APPAREIL.



CAUTION: THESE MODELS ARE DESIGNED, BUILT, AND SOLD FOR COMMERCIAL USE ONLY. IF THESE MODELS ARE POSITIONED SO THE GENERAL PUBLIC CAN USE THE EQUIPMENT, MAKE SURE THAT CAUTION SIGNS, WARNINGS, AND OPERATING INSTRUCTIONS ARE CLEARLY POSTED NEAR EACH UNIT SO THAT ANYONE USING THE EQUIPMENT WILL USE IT CORRECTLY AND NOT INJURE THEMSELVES OR HARM THE EQUIPMENT.

ATTENTION: CES MODÈLES SONT CONÇUS, FABRIQUÉS, ET VENDUS POUR UN USAGE COMMERCIAL SEULEMENT. SI CES MODÈLES SONT PLACÉS POUR QUE LE GRAND PUBLIC PUISSE LES UTILISER, ASSUREZ-VOUS QUE LES CONSIGNES D'ATTENTION, D'AVERTISSEMENT, ET LES INSTRUCTIONS D'UTILISATION SOIENT CLAIREMENT AFFICHÉES PRÈS DE CHAQUE UNITÉ DE SORTE QUE N'IMPORTE QUEL UTILISATEUR DE L'APPAREIL L'EMPLOIE CORRECTEMENT ET NE SE BLESSE PAS OU N'ENDOMMAGE PAS L'APPAREIL.



WARNING: A FACTORY AUTHORIZED SERVICE PROVIDER SHOULD HANDLE ALL MAINTENANCE AND REPAIR. BEFORE DOING ANY MAINTENANCE OR REPAIR, FOLLOW SERVICE SET UP ARRANGEMENT ON PAGE 8.

AVERTISSEMENT: UN TECHNICIEN AUTORISÉ PAR L'USINE DEVRA EFFECTUER TOUT L'ENTRETIEN ET LES RÉPARATIONS. AVANT DE FAIRE TOUT ENTRETIEN OU RÉPARATION, VEUILLEZ CONTACTER WINCO.



Introduction

Congratulations on the purchase of your WINCO® machine. Please take the time to carefully read through this manual to ensure the machine is operated and maintained properly, to ensure the best possible performance from this product for many years.

WINCO will not accept liability if:

- The instructions in this manual have not been followed correctly.
- Non-authorized personnel have tampered with the machine.
- Non-original spare parts are used.
- The machine has not been handled and cleaned correctly.
- There is any use damage to the unit.

Commercial Infrared Strip Heater

Table of Contents

Specifications.....	1
Warnings	2
Introduction	2
Packaging	3
Important Safeguards	4
Cautions Before Use	5
Electrical Requirements	5
Operation	6
Cleaning & Maintenance	6
Safety	7
Service, Repair, Troubleshooting.....	7
Exploded View and Parts List	8
Limited Warranty	10

Package Contents

All units come with an Operating Instruction Manual and the following:

- Electric Strip Heater
- Hanging Chains (ESH-CH)
- Undermount Brackets (ESH-UB)

WINCO prides itself on quality and service, ensuring that at the time of packing, all products are supplied fully functional and free of damage. Should you find any damage as result of freight, please contact your WINCO dealer immediately.

Function and Purpose

This unit is intended for use in commercial food-service operations only. It is not intended for household, industrial or laboratory use.

NOTE

Please remember that this manual and the warning labels do not replace the need to be alert, to properly train and supervise operators, and to use common sense when using this equipment.

Unpacking the Equipment

DISPOSE OF ALL PACKAGING MATERIALS IN AN ENVIRONMENTALLY RESPONSIBLE MANNER.

1. Remove all packing materials and tape, as well as any protective plastic and cardboard, from the unit.
2. Clean any glue residue left over from the plastic or tape.
3. Place the unit in the desired position and height.

SAVE THE ORIGINAL BOX AND PACKAGING FOR USE IN PACKAGING AND SHIPPING THE EQUIPMENT IF SERVICES ARE NEEDED.

Important Safeguards

To ensure safe installation and operation, please carefully read and understand the following statements.

Unless the operator is adequately trained and supervised there is a possibility of serious injury. Owners of this equipment bear the responsibility to make certain that this equipment is used properly and safely, and to strictly follow all of the instructions contained in this manual and the requirements of local, state or federal law.

Owners should not permit anyone to touch this equipment unless they are over 18 years old, are adequately trained and supervised, and have read and understood this manual.

Owners should also ensure that no customers, visitors or other unauthorized personnel come in contact with this equipment. It is the responsibility of the owner and the operator to remain alert to any hazards posed by the function of this equipment.

If there is ever uncertainty about a particular task or the proper method of operating this equipment, ask an experienced supervisor.

Warnings



This manual contains a number of precautions to follow to help promote safe use of this equipment.



This appliance is hot when in use. Do not let bare skin touch hot surfaces! Always keep flammable/combustible materials such as curtains, napkins, flammable cleaners, etc., away from the unit.



Power must be disconnected at the power source prior to cleaning, or performing any service procedure or repairs.

 HOT	WARNING  AVERTISSEMENT
	USE CAUTION WHEN TOUCHING THE UNIT. Ne touchez pas le liquide chaud ou les surfaces de chauffage lorsque l'appareil chauffe ou en fonctionnement.

FOR YOUR SAFETY

Do not store or use gasoline or other flammable vapors and liquids in the vicinity of this or any other appliance.

ESURE DE SECURITE

Ne pas entreposer ni utiliser de l'essence ni autres vapeurs ou liquides inflammables a proximite de cet appareil ou de tout autre appareil!

WARNING

Improper installation, adjustment, alteration, service or maintenance can cause property damage, injury or death.

Read these installation, operating and maintenance instructions thoroughly before installing or servicing this equipment.

AVERTISSEMENT

L'installation, le réglage, la modification, la réparation ou l'entretien incorrect de cet appareil peut causer des dommages matériels, des blessures ou la mort.

Lire attentivement les instructions d'installation, de fonctionnement et d'entretien avant de procéder a son installation ou entretien.

TO PURCHASER

Contact your local gas supplier and ask for instructions in the event the user smells gas. This information should be posted in a prominent location.

À L'ACHETEUR

Communiquez avec votre distributeur de gaz et informez vous quant aux procédés a suivre si vous détectez une odeur de gaz. Cette information doit être affichée a un endroit facile d'accès et très visible.

Warning

Improper installation, adjustment, alteration, service or maintenance can cause property damage, injury or death. Read the installation, operation, and maintenance instructions thoroughly before installing or servicing this equipment.

Caution Before Using Appliance

1. Read all instructions carefully. Do not use this appliance for anything other than its intended use.
2. Do not touch surfaces that may be hot - be sure to always use handles or knobs.
3. Unplug from outlet when not in use, prior to installing or removing parts, and before cleaning. Allow for the device to cool first.
8. Do not operate this device or any other electrical equipment with a damaged switch, cord or plug, or after the unit malfunctions, is dropped or damaged in any manner. Return to the nearest WINCO Authorized Service Center for examination, repair, and / or adjustment.
9. The use of accessory attachments not recommended by WINCO may cause fire, electric shock or injury.

WARNING ⚠️ AVERTISSEMENT	
	Electrical Shock Hazard Keep water and other liquids from entering the inside of the unit. Liquid inside the unit could cause an electrical shock.
	Risque de choc électrique Conserver l'eau et d'autres liquides de pénétrer à l'intérieur de l'appareil. Liquide à l'intérieur de l'appareil pourrait provoquer un choc électrique.
	Do not spray water or cleaning products. Liquid could contact the electrical components and cause a short circuit or an electrical shock. Do not use unit if power cord is damaged or has been modified.
	Ne pas pulvériser de l'eau ou des produits de nettoyage. Le liquide pourrait contacter avec les composants électriques et causer un court-circuit ou un choc électrique. Ne pas utiliser l'appareil si le cordon d'alimentation est endommagé, ou a été modifié.

4. To protect against the risk of electrical shock, do not immerse the appliance, cord or plug in water or other liquids.
5. Do not use an adapter.
6. Do not use an extension cord.
7. Do not remove ground.

WARNING ⚠️ AVERTISSEMENT	
	Fire Hazard. Correct installation precautions, procedures and regulations must be followed. Operation and safety training is necessary for all users of this equipment.
	Risque d'incendie La surchauffe des vapeurs d'huile ou de l'huile peut s'enflammer et provoquer un incendie. Surveillez la température, la qualité et le niveau d'huile. Utilisez et entretenez le système d'élimination des vapeurs d'huile.

10. Not intended for outdoor installation.
11. Do not let the cord hang over the edge of a table or counter, or touch hot surfaces.
12. Do not place on or near a heat source.
13. This appliance should always be on a stable and steady countertop or table when legs are in use.
14. When using the undermount brackets (ESH-UB), make sure to secure the unit to a stable, noncombustible surface (such as a metal shelf).
15. This appliance is not intended for use by individuals (including children) with reduced or impaired physical, sensory, or mental capabilities, or lack of experience or knowledge, unless they have been given proper supervision or instruction concerning the use of this appliance by a person responsible for their safety.
16. Children should be supervised at all times to avoid injuring themselves or damaging the appliance in any way.
17. Clean the unit with caution – do not clean when unit is plugged in or when hot.
18. Do not place metal objects such as knives, forks or spoons in the heater as it may damage the unit, and may also result in injury.
19. Do not store any item on top of this unit when in operation.
20. Never place materials such as paper, cardboard, plastic, etc. on or under this unit.

Proper Grounding

This machine is provided with a three-pronged grounding plug. The outlet to which this plug is connected must be properly grounded. If the receptacle is not the proper grounding type, contact an electrician. DO NOT, under any circumstances, cut or remove the third ground prong from the power cord or use any adapter plug.

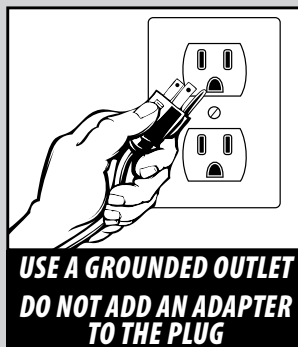

Operation

1. Plug power cord into a receptacle.
2. Turn the POWER switch to the ON (up) position.
3. The red HEAT indicator should light up when on.
4. Place food products under the heater to keep warm.
5. Turn the POWER switch to the OFF (down) position to turn off when not in use.

When attaching undermount brackets, install unit to the mounting surface with the following clearances:

- 9" minimum clearance between end of the unit and any/all walls
- 12" min. clearance between side of unit and any wall
- 16" min. clearance between bottom of unit and countertop surface
- 2" min. clearance between top of unit and any overhead surface

CAUTION: HOT!



CAUTION

*The unit will be HOT after use!
Let cool before cleaning.*



Cleaning & Maintenance

Before using this equipment it must be cleaned and dried thoroughly. Clean all surfaces before use. Failure to clean surfaces before using the unit could cause food contamination.

Always unplug the unit after every use and before cleaning. Unplug the unit when not in operation.

- Allow unit to cool completely before cleaning.
- Clean main body with a damp cloth and degreaser solution if desired.
- Allow to dry before turning the unit back on.
- Do not immerse the device completely in water to clean. The appliance should also NOT be cleaned with a water jet.

NOTE:

Proper cleaning instructions must be followed; otherwise, operation of the unit may be seriously impaired. Do not wash parts in an automatic dishwasher.

WINCO authorized service personnel must perform any other servicing.

Safety

A WINCO® Approved Service Technician should carry out repairs if necessary. Do not remove any components or service panels on this product.

If the power cord is damaged, it must be replaced by a WINCO Approved Service Technician in order to avoid a hazard.

Service and Repair

There are no user serviceable parts within this appliance. To avoid serious injury or damage, **NEVER** attempt to repair the unit yourself.

To initiate warranty service contact: support@wincous.com or call: 973-295-3899.

DO NOT send unit to WINCO without first contacting our customer service department.

See "Limited Warranty" section on page 8 for details.

Troubleshooting

If your WINCO Infrared Strip Heater does not operate, please check the following prior to placing a service call.

PROBLEM	POSSIBLE CAUSE	RECOMMENDED SOLUTION
The unit is not turning on	Power supply cord	Check that the power supply cord is correctly plugged in and outlet is working.
	Switches have not been turned on	Check that the switch is in the ON position.
	Plug/cord or external wiring is damaged	Call WINCO to make service arrangements through their service provider network.
	Internal wiring fault	
The unit is not heating up	Heater needs replacement if light is on	Call WINCO to make service arrangements through their service provider network.
	Light does not come on	See "unit is not turning on" section.
Heating light does not come	Does not get hot	See "unit is not turning on" section.
	It gets hot but only the light is off	Light/switch/wiring needs to be replaced. Call WINCO to make service arrangements through their service provider network.

Exploded View

MODEL: ESH-SERIES STRIP HEATER

1) COVER PLATE

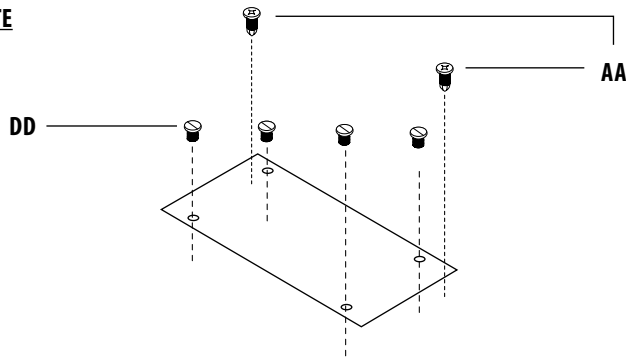

2) COVER

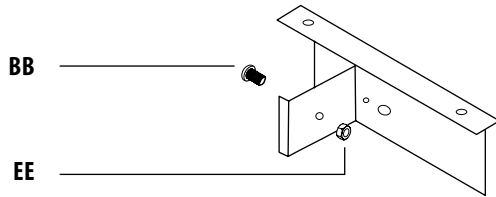

3) END CAP

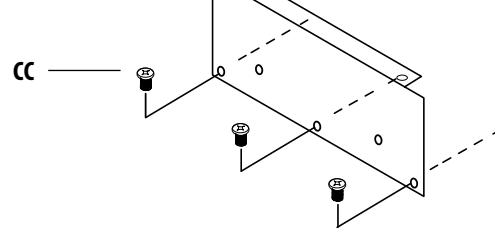

4) STRIP HEATER ASSEMBLY

(PRODUCT RATINGS)

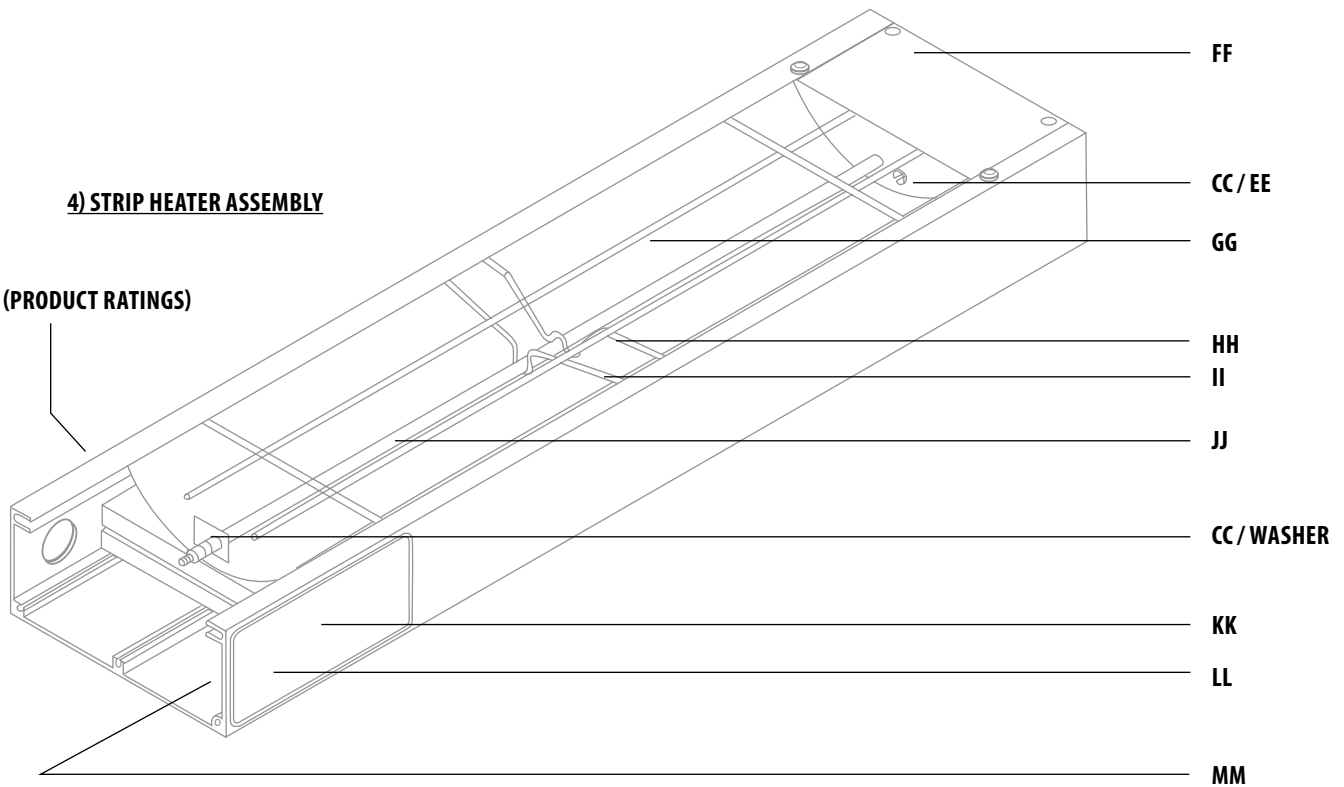

Parts List

MODEL: ESH-SERIES STRIP HEATER



REF.	DESCRIPTION	QTY	
AA	Screw 8 x 1/2"	4	
BB	Screw 8-32 x 3/8"	6	
CC	Screw 8-32 x 1/4"	6	
DD	Screw 6-32 x 1/2"	2	
EE	Nuts 8-32	4	
FF	Cover Plate	1	
GG	Heating Element Guard	1	
HH	Support - Top	1	
II	Support - Bottom	1	
JJ	Element (120V)	1	
MM	Thermostat	1	
REF.	REPLACEMENT PARTS	QTY	ITEM#
KK	Indicator light (red)	1	FWS500-P10
LL	Toggle switch	1	ESH-P1
	Undermount bracket and screws	1 (Set)	ESH-UB
	Metal Hanging chain	2 per unit	ESH-CH



Limited Warranty

WINCO® warrants to the original purchaser of new equipment that said equipment, when installed in accordance with our instructions within North America and subjected to normal use, is free from defects in material or workmanship for a period of 1 year. The labor warranty is one year from original installation or 18 months from actual factory shipment date, whichever date occurs first.

THIS WARRANTY IS IN LIEU OF ALL OTHER WARRANTIES, WHETHER EXPRESSED OR IMPLIED. WINCO EXPRESSLY DISCLAIMS ANY IMPLIED WARRANTY OF MERCHANTABILITY OR EXPRESSED OR IMPLIED WARRANTY OF FITNESS FOR A PARTICULAR PURPOSE.

WINCO'S OBLIGATION AND LIABILITY UNDER THIS WARRANTY IS EXPRESSLY LIMITED TO REPAIRING AND REPLACING EQUIPMENT THAT PROVES TO BE DEFECTIVE IN MATERIAL OR WORKMANSHIP WITHIN THE APPLICABLE WARRANTY PERIOD.

IN NO EVENT SHALL WINCO BE LIABLE FOR INCIDENTAL OR CONSEQUENTIAL DAMAGES TO BUYER OR ANY THIRD PARTY, INCLUDING, WITHOUT LIMITATION, LOSS OF PROPERTY, PERSONAL INJURY, LOSS OF BUSINESS OR PROFITS OR OTHER ECONOMIC LOSSES, OR STATUTORY OR EXEMPLARY DAMAGES, WHETHER IN NEGLIGENCE, WARRANTY, STRICT LIABILITY, OR OTHERWISE.

This warranty is given only to the first purchaser from a retail dealer. No warranty is given to subsequent transferees.

Warranty does not cover product failures caused by: failure to maintain, neglect, abuse, damage due to excess water, fire, normal wear, improper set up and use. Periodic maintenance is not covered.

This warranty is not in force until such time as a properly completed and digitally signed Installation/Warranty Registration has been received by WINCO within 30 days from the date of installation.

WARRANTY SERVICE

To initiate warranty service contact: support@winco.us
or call: 973-295-3899

DO NOT send unit to WINCO® without first contacting our customer service department.

REGISTER ONLINE AT:

<http://support.winco.us>

Proof of purchase is required to extend warranty more than 1 year from date of shipment from the factory.

Limited Warranty

THE FOREGOING WARRANTY PROVISIONS ARE A COMPLETE AND EXCLUSIVE STATEMENT BETWEEN THE BUYER AND SELLER. WINCO® NEITHER ASSUMES NOR AUTHORIZES ANY PERSONS TO ASSUME FOR IT ANY OTHER OBLIGATION OR LIABILITY IN CONNECTION WITH SAID EQUIPMENT.

Examples of items not covered under warranty, but not limited to just these items:

1. Acts of God, fire, water damage, burglary, accident, theft.
2. Freight damage.
3. Improper installation or alteration of equipment.
4. Use of generic or after-market parts.
5. Repairs made by anyone other than a WINCO® designated service provider.
6. Lubrication.
7. Expendable wear parts, adjustable feet, blown fuses, lamps, etc.
8. Cleaning of equipment.
9. Misuse or abuse.

WARRANTY REGISTRATION

SCAN THE QR CODE WITH YOUR MOBILE DEVICE

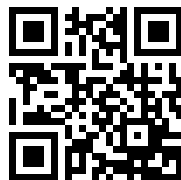

or go to

<http://support.wincous.com>

TO FILL OUT AND SUBMIT YOUR WARRANTY REGISTRATION.

Please keep this manual in a safe place for future use!



winco[®]

Model: ESH-Series

www.wincous.com