

Project _____
 Item _____
 Quantity _____
 CSI Section 11400
 Approved _____
 Date _____

Garland Induction

INSTINCT SERIES - COUNTERTOP WOK 3.5 & 5.0kW

Models

- GiiC-SW3.5 (formerly SHWO3500)
- GiiC-SW5.0 (formerly SHWO5000)

powered by
INDUCS



INSTINCT WOK 3.5 / 5

Standard Features

- Realtime Temperature Control System RTCsmp®
- 12 power levels
- 11.8 inches (300 mm) Ceran Wok Glass Diameter
- Timer function
- Energy efficient
- Convenient and reliable
- Heats up quickly
- Overheat protection
- Easy to clean, high temperature ceran glass top
- LED Display
- Simple and intuitive "Tap and Turn" knob
- Includes plug and cord (6 ft. - 1.8 m)



Properties

- Continuous temperature measurement at the bottom of the pan with RTCsmp technology (Realtime Temperature Control System multi-point)
- Automatic shut-off feature prevents overheating and prolongs the life of both the wok and the cookware
- Even heat for optimal cooking results
- Direct heat transfer eliminates heat in the area around the wok
- Cool to the touch cooking surface means no burned on food after cooking
- Reduction of the maximum power from 100% to 25%
- Single-phase version (up to 3.5kW) at 208V - 240V: identical worldwide
- The wok adjusts to the power available
- Requires the use of induction-compatible pan
- Warranty: 2 years on parts & labor (US and Canada only)

Advanced Features

- Even heat distribution across the entire cooking surface
- Height-adjustable, locking feet
- Removable, washable and reusable air filter
- Incoming Voltage Detection
- Easy Power Reduction
- Quiet ventilation for less noise





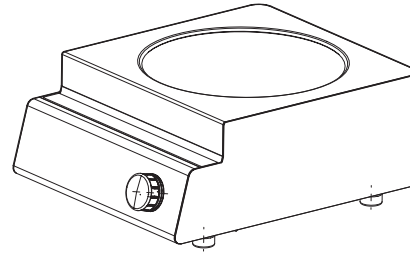
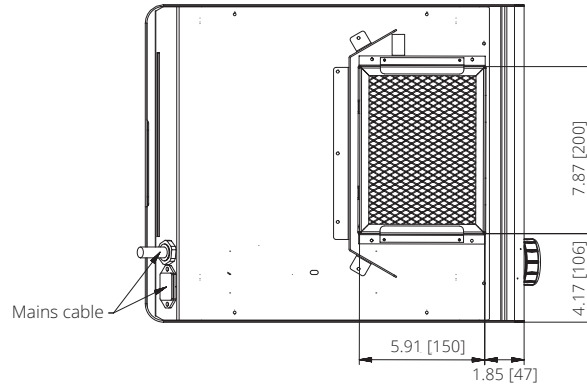
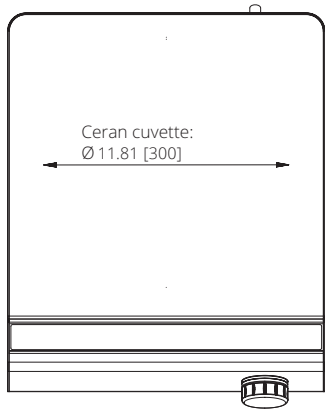
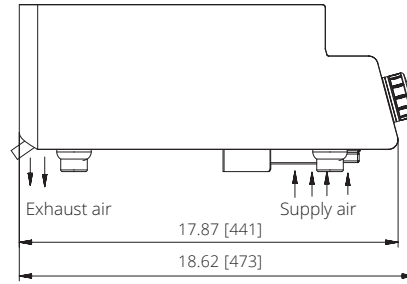
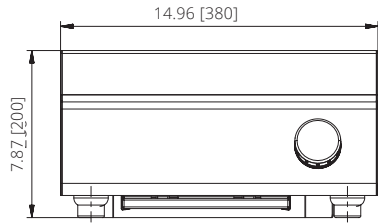

INSTINCT™ GARLAND INDUCTION WOK (COUNTER-TOP), WOK CERAN BOWL 11.8 INCHES DIAMETER

Dimensions are specified in inches [mm]



- Number of heating zones 1
- Ceran glass surface diameter 11.8 inches / 300 mm Wok Ceran bowl
- Inductor diameter Inductor coil 10.63 inches / 270 mm
- Power levels 12
- Housing Stainless steel

Model	INSTINCT WOK 3.5		INSTINCT WOK 5	
Model Number	GIIC-SW3.5		GIIC-SW5.0	
Dimensions W (L) x D (P) x H	14.96 x 18.62 x 7.87 inches [380 x 473 x 200 mm]		14.96 x 18.62 x 7.87 inches [380 x 473 x 200 mm]	
Weight	31 lbs [14 kg]		36 lbs [16 kg]	
Electrical Specifications	Single Phase		3 Phases	
Power, Watts	3500W - 17 amp		5000W - 14 amp	
Electrical supply V/Hz	208-240 V/50-60 Hz/1		208-240 V/50-60 Hz/3	380-440 V/50-60 Hz/3
Certification Marks	UL	CE	UL	CE
Plug (to precise at time of order)	 NEMA 6-20P	 EU1-16P	 NEMA L15-20P	 EU 5-Pole
Shipping Information				
Dimensions W (L) x D (P) x H	26.38 x 18.51 x 11.42 inches [670 x 470 x 290 mm]		26.38 x 18.51 x 11.42 inches [670 x 470 x 290 mm]	
Weight	40 lbs [18 kg]		42 lbs [19 kg]	

Note:

Garland products are not approved or authorized for home or residential use, but are intended for commercial applications only. Garland will not provide service, warranty, maintenance or support of any kind other than in commercial applications.

Welbilt reserves the right to make changes to the design or specifications without prior notice.

Garland Commercial Ranges Ltd.
1177 Kamato Road,
Mississauga, Ontario
L4W 1X4 CANADA

General Inquiries 1-905-624-0260
USA Sales 1-800-424-2411
Canadian Sales 1-888-442-7526
US/Canada KitchenCare Parts & Service
1-844-724-2273

www.garland-group.com
6584E
02/24

