



“WE MAKE THE KITCHEN BETTER!”

ATOSA USA, INC.

Toll Free: 855-855-0399 Email: info@atosausa.com

www.atosa.com | www.atosausa.com

California, Colorado, Florida, Georgia, Illinois, New Jersey, Ohio, Texas, Washington

Open Air Merchandisers

Standard Features

- Black exterior & stainless steel interior
- Digital temperature controller and display
- Maintains temperatures between 33 °F to 40 °F
- Glass side and front panels
- LED interior lighting under shelf and interior top
- One stainless steel shelf and one floor shelf
- Pre-installed casters

Optional Accessories

- Top Mount Dry Display Case

MODELS:

ATHOM-28 / ATHOM-39 / ATHOM-60



ATHOM-28



ATHOM-39



ATHOM-60

For the best results of food preservation we recommend setting your refrigerator between 33°F to 38 °F

1. Don't forget to leave the unit some room to breathe!
2. Please clean the condenser frequently to give the unit more fresh air.



2 YEAR PARTS AND LABOR WARRANTY
5 YEAR COMPRESSOR PART WARRANTY





"WE MAKE THE KITCHEN BETTER!"

ATOSA USA, INC.

Toll Free: 855-855-0399 Email: info@atosausa.com

www.atosa.com | www.atosausa.com

California, Colorado, Florida, Georgia, Illinois,

New Jersey, Ohio, Texas, Washington

SPECIFICATIONS

Models	Capacity (Cu.Ft.)	Voltage (V/Hz/Ph)	HP	Refrigerant	NEMA Plug	Exterior Dimensions (inch)	Packaging Dimensions (inch)	Shelf Dimensions (inch)	Net Weight (lbs)	Gross Weight (lbs)
ATHOM-28	4.1	115/60/1	3/5	R290	5-20P	26 ^{13/16} ×34 ^{9/16} ×44 ^{3/8}	29 ^{9/10} ×37 ^{3/5} ×49 ^{2/5}	22 ^{3/4} ×11	145	180
ATHOM-39	6.18	115/60/1	3/5	R290	5-20P	38 ^{5/8} ×34 ^{9/16} ×44 ^{3/8}	41 ^{7/10} ×37 ^{3/5} ×49 ^{2/5}	34 ^{9/16} ×11	200	244
ATHOM-60	10.27	115/60/1	3/5	R290	5-20P	62 ^{1/4} ×34 ^{9/16} ×44 ^{3/8}	65 ^{2/5} ×37 ^{3/5} ×49 ^{2/5}	58 ^{3/16} ×11	254	312

PLAN VIEW

ATHOM-28

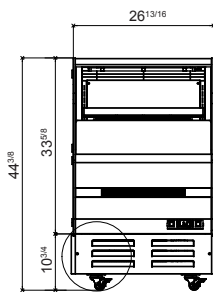

ATHOM-39

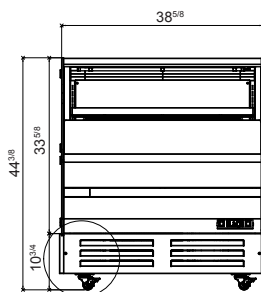

ATHOM-60

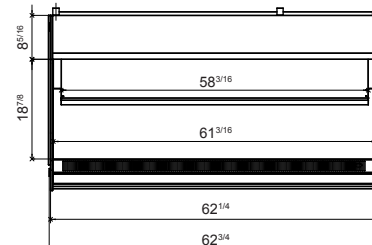
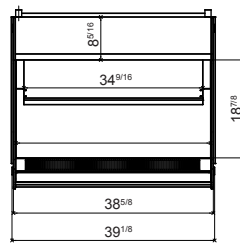
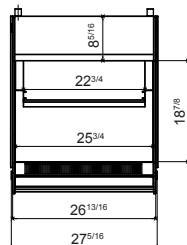
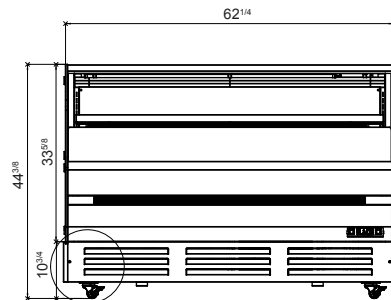

Side View

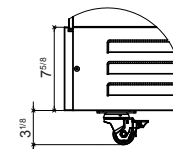
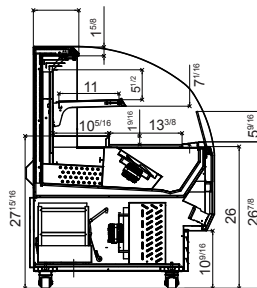
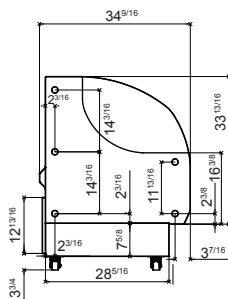

Electronic Temp. Controller

