



KM-350/520/660M_J(Z)

SLIM-LINE MODULAR CRESCENT CUBER



KM-350/520/660M_J(Z)
07/02/24
Item # 13260

Item #: _____
Project: _____
Qty: _____
AIA#: _____

W x D x H
22" x 27^{3/8}" x 28"

KM|EDGE[™]X
ICE MACHINE SERIES

Air-Cooled

- KM-350MAJ ★
- KM-520MAJ ★
- KM-660MAJ



Air-cooled model shown on optional bin: B-300

Water-Cooled

- KM-350MWJ
- KM-520MWJ
- KM-660MWJ



Remote Air-Cooled

- KM-520MRJZ ★
- KM-660MRJZ ★



Features

- ▶ Individual crescent cube
- ▶ Factory-installed ultrasonic bin control can be adjusted on site
- ▶ Simple, one-hour cleaning process 

- Durable construction with fewer parts
- Self-diagnostic programming automatically adjusts to changing conditions
- Snap fit parts for easy cleaning
- Stainless steel double-sided evaporator
- CycleSaver[™] design 
- EverCheck[™] alert system 
- Removable air filters (air-cooled model only)
- R-404A Refrigerant

Available on Bins/Dispensers:

B-250SF	B-500/SF	B-800SF	B-1150SS	DB-130H
B-300SF	B-700SF	B-900SF	B-1300SS	DB-200H
				DM-200B

Top kit may be required. See Bin Spec Sheets.

Warranty:

3 Year Parts & Labor on entire machine 5 Year Parts & Labor on evaporator 5 Year Parts on Compressor; air-cooled condenser coil Valid in United States, Canada, Puerto Rico and U.S. Territories. Contact factory for warranty in other countries.

Shipping: (LxWxH) 33.5" x 25.88" X 34.6" Volume: 17.36ft³



Condenser	Model	ICE PRODUCTION		WATER USAGE			ELECTRICAL						
		Air / Water Temp Lbs. per 24 hours 70°/50°F	90°/70°F	Potable Gal. per 100 lbs. 90°/70°F	Condenser Gal. per 100 lbs. 90°/70°F	kWh Used per 100 lbs. 90°/70°F	Min. Circuit/Max. Fuse Size	Amperage	Voltage	Circuit Wires (including ground)	Heat Rejection BTU/hr.	Refrigerant Charge Amount	Net / Ship Weight (lbs.)
Air	KM-350MAJ ★	489	393	14.5	N/A	5.42	15A	9.05A	115V/60/1	3	5,700	1 lb. 3.4 oz.	125 / 175
Water	KM-350MWJ	414	383	15.5	109	4.90	15A	7.5A	115V/60/1	3	6,600	11.6 oz.	126 / 175
Air	KM-520MAJ ★	556	480	14.7	N/A	4.68	20A	10.6A	115V/60/1	3	6,600	1 lb. 10.8 oz.	145 / 175
Water	KM-520MWJ	474	444	14.8	75	4.65	20A	8.45A	115V/60/1	3	6,300	12.7 oz.	127 / 175
Remote	KM-520MRJZ ★	547	495	13.6	N/A	4.80	20A	12.05A	115V/60/1	3	6,200	2 lb. 4.7 oz. 4 lb. 2.7 oz. [†]	145 / 175
Air	KM-660MAJ	650	560	14.8	N/A	5.3	20A	15.2A	115V/60/1	3	8,000	1 lb. 9.8 oz.	150 / 180
Water	KM-660MWJ	647	630	16.1	152	4.28	20A	12.35A	115V/60/1	3	8,900	15.2 oz.	130 / 180
Remote	KM-660MRJZ ★	642	570	15.0	N/A	5.25	20A	16.1A	115V/60/1	3	8,100	2 lb. 4.7 oz. 4 lb. 2.7 oz. [†]	150 / 180

[†] (with condenser)

Power cord not included. Must be hard-wired at site.

Hoshizaki reserves the right to change specifications without notice.



KM-350/520/660M_J(Z)

KM-350/520/660M_J(Z)
07/02/24
Item # 13260

SLIM-LINE MODULAR CRESCENT CUBER

KMEdge™ Cube Dimensions*

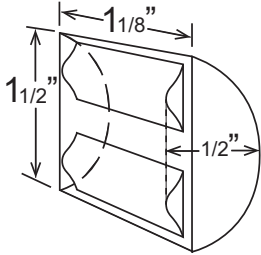

* approximate size in inches, image not to scale

Operating Limits

- Ambient Temp Range 45 - 100°F
- Water Temp Range 45 - 90°F
- Water Pressure 10 - 113 PSIG
- Voltage Range 104 - 127V
- If GFCI is required, a GFCI breaker MUST be used in lieu of GFCI receptacle

Service

- Panels easily removed and all components accessible for service.
- Removable/cleanable air filters. (Air-cooled model only)
- Allow 6" (15 cm) clearance at rear, sides, and top for proper air circulation and ease of maintenance/service.

Plumbing

- Icemaker water supply line: minimum 1/4" nominal ID copper water tubing or equivalent
- Icemaker drain line: minimum 3/4" nominal ID hard pipe or equivalent Water-Cooled Model (Lines Must Be Independent of Icemaker)
- Condenser water supply line: minimum 1/4" nominal ID copper water tubing or equivalent
- Condenser drain/return line: minimum 1/4" nominal ID hard pipe (open drain system) or copper water tubing (closed loop system) or equivalent

Water Filter

Please refer to water filter specification sheet for recommendations.

FRONT VIEW

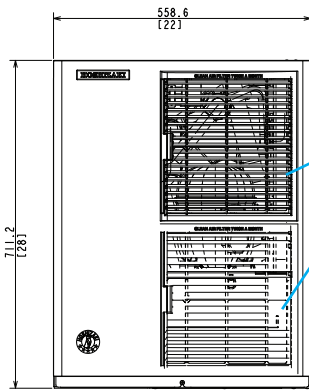

Louvers on Air-Cooled models only

SIDE VIEW

Louvers on Air-Cooled models only

Front →

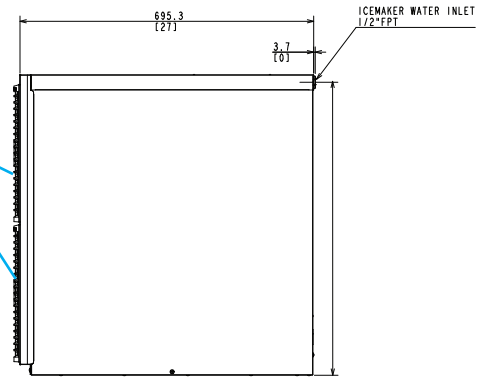

REAR VIEW

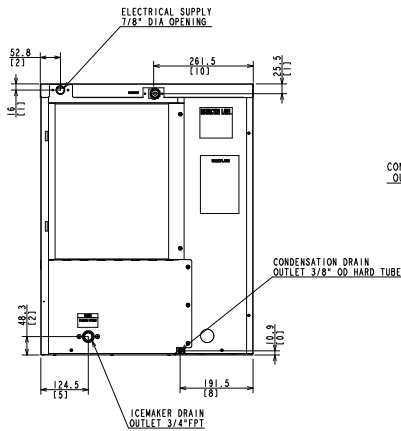

AIR-COOLED

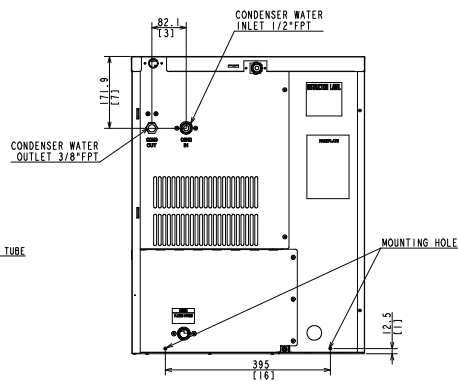

WATER-COOLED

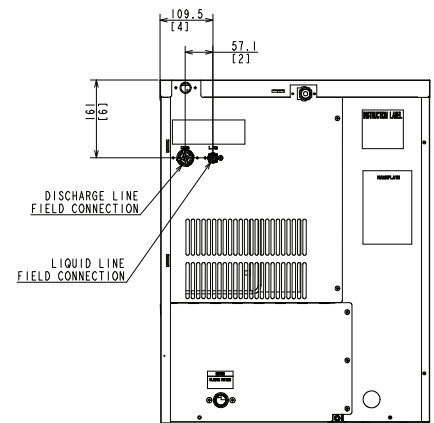

REMOTE AIR-COOLED

BOTTOM VIEW

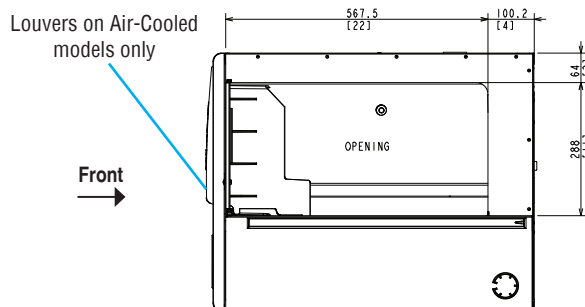

URC-5FZ Remote Condenser (Sold Separately)

(W x D x H) 21^{13/16} x 14^{1/16} x 32^{13/16}

For Use with KM-520MRJZ and KM-660MRJZ

Braze Line Sets (Sold Separately)
25' HS-5587
35' HS-5588

