

WEQ-10(1.5)5

Height: 15.65" Width: 6.12" Depth: 5.54"
(39.8cm) (15.5cm) (14.1cm)



- Sanitary quick connect valve-in-head design simultaneously shuts off and vents water with ¼ turn, allowing for simple cartridge change-outs and maintenance times
- Unique modular filter head manifold design allows for simple installation, customization, and future system expansion
- Auto-leveling technology ensures perfect installation every time
- Designed for low volume applications using a unique blend of catalytic coconut shell carbon rated up to 10,000 gallons to reduce chlorine taste and odor for consistent, great tasting cold and hot beverages, hot water, and ice
- Select filters NSF certified to Standard 42 for reduction of Sediment, Chlorine Taste and Odor and Chloramines
- Certified to NSF Standard 42 for Sediment, Chlorine Taste and Odor reduction
- Includes single stage filter head assembly with manifold bracket, 3/8" MNPT fittings and 1/4" quick-connect rinse valve

NOTE: Do not use with water that is microbiologically unsafe or of unknown quality without adequate disinfection before or after the system.

Specifications

Product #: 56000.0027

Cartridge Type: Quick Change

Application(s): Post Mix, Drinking Water, Backroom Package/Combo System

Replacement Cartridge: 56000.0122

Filtration Type: Sediment, Chlorine Taste & Odor

Filter Change Frequency: Every 6 months

Capacity

Micron Rating	Service Flow Rate	Water Filter Capacity Chlorine Reduction	Water Filter Capacity Chloramine Reduction	Water Filter Capacity Softening
5.0	1.5 gal/min (5.7 L/min)	10000 gal. (37853.4 L)	-	-

Plumbing Requirements

Inlet Connection	Outlet Connection	Min Operating Pressure	Max Operating Pressure	Min Operating Temperature	Max Operating Temperature
3/8 IN	3/8 IN	20 psi (138 kPa)	125 psi (862 kPa)	40°F(4°C)	100°F(38°C)

WARNING:



BUNN® reserves the right to change specifications and product design without notice. Such revisions do not entitle the buyer to corresponding changes, improvements, additions or replacements for previously purchased equipment. For most current specifications and other info visit bunn.com.

Last Updated:
02/02/2022

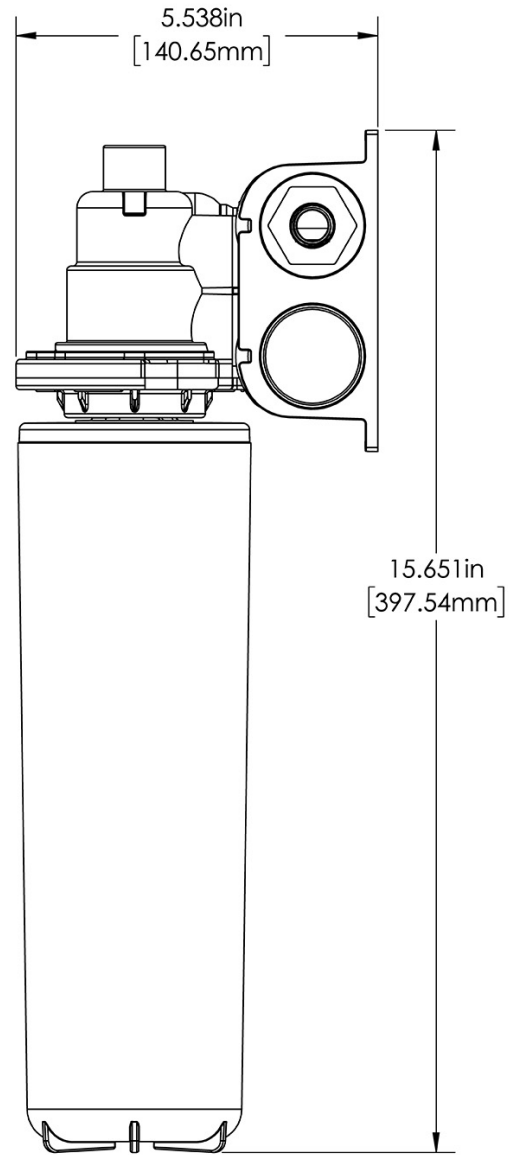
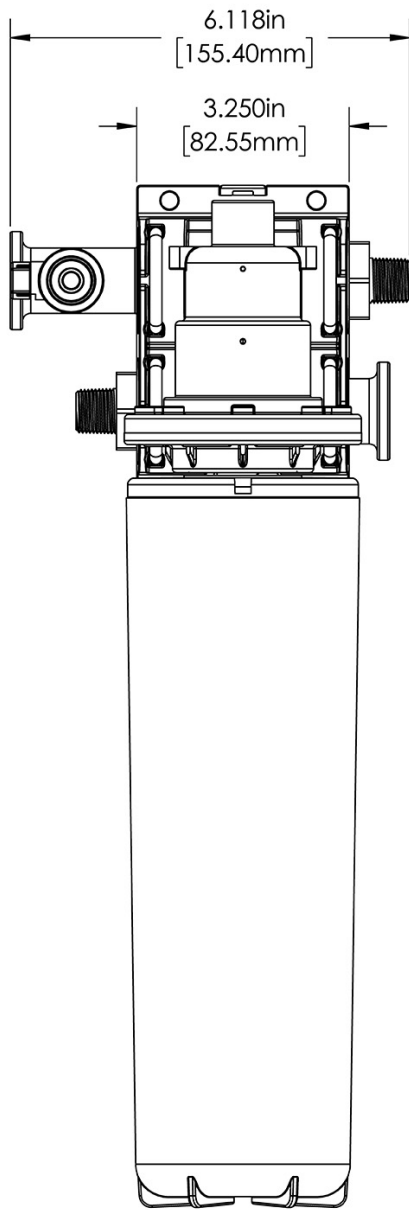

Dimensions of Filter System <i>(filter head with filter cartridge)</i>			Installed Dimensions <i>(Installation with wall mounting)</i>			Cartridge Dimensions <i>(filter cartridge only)</i>			
	Height	Width	Depth	Height	Width	Depth	Height	Width	Depth
English	15.65 in.	6.12 in.	5.54 in.	-	-	-	13.12 in.	3.57 in.	3.57 in.
Metric	39.8 cm	15.5 cm	14.1 cm	-	-	-	33.3 cm	9.1 cm	9.1 cm

Weight			Shipping				
	Dry	Wet	Height	Width	Depth	Weight	Volume
English	0.0 lbs	0.0 lbs	8.00 in.	15.00 in.	20.00 in.	6.920 lbs	-
Metric	-	-	20.3 cm	38.1 cm	50.8 cm	3.139 kgs	-

WARRANTY: BUNN High Performance Water Filtration Solutions Systems by BUNN® (excluding water filters and water treatment replacement cartridges) are covered by a limited warranty against defects in material and workmanship for a period of five years after date of purchase, under normal use and service, and when installed in accordance with manufacturer's recommendations outlined in the filtration systems owner's manual. BUNN replaceable elements (water treatment cartridges, filter elements, and feeder elements) are covered by a limited warranty against defects in material and workmanship for a period of one year after date of purchase or the remainder of the original warranty, whichever is longer. See printed warranty for full details. BUNN will provide a copy of the warranty upon request.



BUNN® reserves the right to change specifications and product design without notice. Such revisions do not entitle the buyer to corresponding changes, improvements, additions or replacements for previously purchased equipment. For most current specifications and other info visit bunn.com.

Last Updated:
02/02/2022

Related Products & Accessories: WEQ-10(1.5)5(56000.0027)



CARTRIDGE, WEQ-10
(1.5)5

Product #: 56000.0122



HEAD ASSEMBLY, WEQ-
SINGLE

Product #: 56000.0201



BUNN® reserves the right to change specifications and product design without notice. Such revisions do not entitle the buyer to corresponding changes, improvements, additions or replacements for previously purchased equipment. For most current specifications and other info visit bunn.com.

Last Updated:
02/02/2022

Model Compatibility: WEQ-10(1.5)5(56000.0027)

Serving and Holding selections are currently unavailable. Please contact your sales representative to find out more information.



BUNN® reserves the right to change specifications and product design without notice. Such revisions do not entitle the buyer to corresponding changes, improvements, additions or replacements for previously purchased equipment. For most current specifications and other info visit bunn.com.

Last Updated:
02/02/2022