



COMPETITOR SERIES®

PROJECT: _____
 LOCATION: _____
 ITEM#: _____
 QUANTITY: _____



C-F35-NG/LP



C-F40-NG/LP



C-F50-NG/LP



C-F75-NG/LP

FRYERS

- Electro-mechanical thermostat for adjusting temperature within a range of 200°F to 400°F
- 34,000 BTU (NG) and 30,000 BTU (LP) per burner
- Beautiful ergonomic design and easy to clean
- All stainless steel tank & cabinetry
- Removable basket hanger for cleaning purposes
- Manual pilot ignition
- Auto reset high limit control for high temperatures
- Cooling zone inside the fryer tank
- Twin nickel chrome plated wire mesh baskets with blue plastic coated handles
- Built in flue deflector
- Full port drain within valve
- Standard with 6" casters (2x Locking)
- Accessory: optional casters upon request
- Migali Industries® Protection Plan: 1 Year Parts & Labor Warranty, 5 Years Oil Tank Warranty

MODEL	BURNERS	VOLUME	TOTAL BTU NG / LP	BTU PER BURNER NG / LP	IN TAKE TUBE PRESSURE (W.C.) NG / LP	NOZZLE NO. NG / LP	IGNITION	VALVE TYPE	THERMOSTAT TEMP LIMIT	TEMP LIMIT	EXTERIOR DIMENSIONS W X D X H	PACKAGING DIMENSIONS W X D X H	WEIGHT	PACKAGED WEIGHT
C-F35-NG / C-F35-LP	3	35 lbs.	60,000 / 60,000	20,000 / 20,000	2/5	#36 / #52	Manual	Often open flame, flame protection	400° F	450° F	15.6 x 30.1 x 44.4	17.7 x 33.5 x 37.9	135 lbs.	160 lbs.
C-F40-NG / C-F40-LP	3	40 lbs.	102,000 / 90,000	34,000 / 30,000	4/10	#36 / #52	Manual	Often open flame, flame protection	400° F	450° F	15.6 x 30.1 x 44.4	17.7 x 33.5 x 37.9	135 lbs.	160 lbs.
C-F50-NG / C-F50-LP	4	50 lbs.	136,000 / 120,000	34,000 / 30,000	4/10	#36 / #52	Manual	Often open flame, flame protection	400° F	450° F	15.6 x 30.1 x 44.4	17.7 x 33.5 x 37.9	146 lbs.	172 lbs.
C-F75-NG / C-F75-LP	5	75 lbs.	170,000 / 150,000	34,000 / 30,000	4/10	#36 / #52	Manual	Often open flame, flame protection	400° F	450° F	21.1 x 30.1 x 44.4	23.2 x 33.5 x 37.9	166 lbs.	200 lbs.

Gas Connection: 3/4" NPT on the right

Clearance for combustible work area: 6" rear & 15" sides - Do Not Store Combustibles Underneath Unit

NOTE: Altitudes over 2,000 feet may need high latitude orifice adjustments to deliver BTU output listed

FOR COMMERCIAL USE ONLY

NOTE: MIGALI® RESERVES THE RIGHT TO CHANGE SPECIFICATIONS WITHOUT NOTICE



TOLL FREE: 800.852.5292
 WEB: www.migali.com



DIMENSIONAL DRAWINGS

C-F35-NG/LP

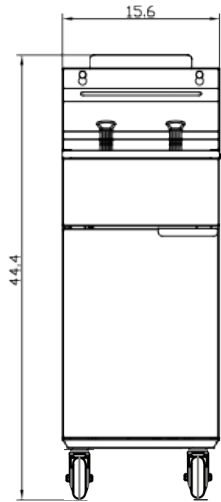

C-F40-NG/LP

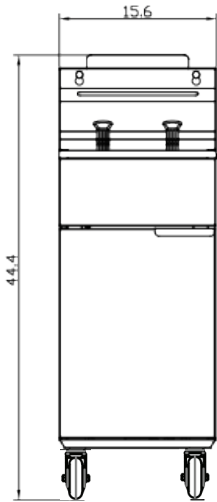

C-F50-NG/LP

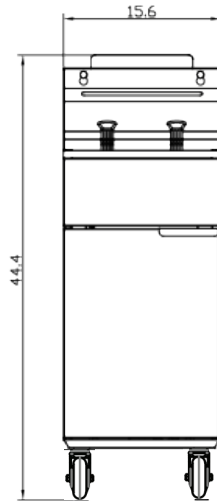

C-F75-NG/LP

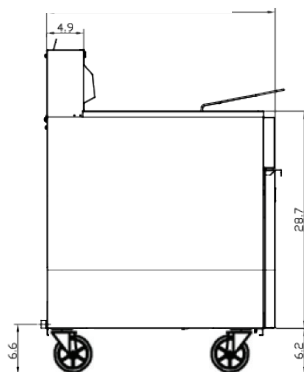
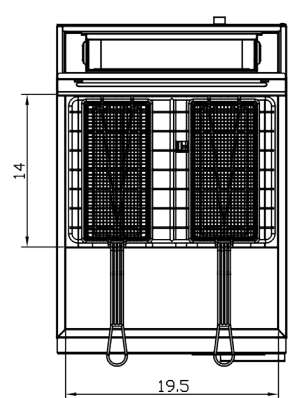
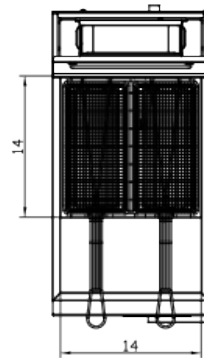
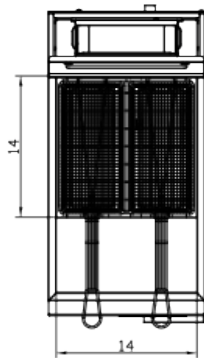
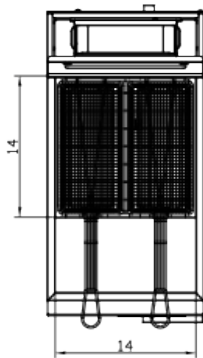
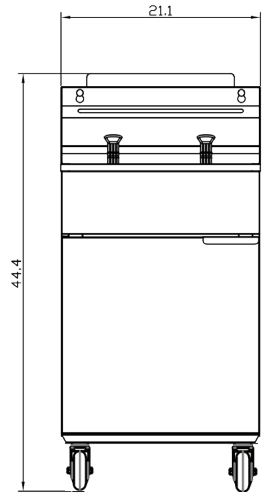

SIDE VIEW



MIGALI® REMAINS AN AMERICAN FAMILY COMPANY SINCE 1955